

International
IR Rectifier

SAFEIR Series 10ETS12, 10ETS12S

INPUT RECTIFIER DIODE

Description/Features

The 10ETS.. rectifier **SAFEIR** series has been optimized for very low forward voltage drop, with moderate leakage. The glass passivation technology used has reliable operation up to 150°C junction temperature.

Typical applications are in input rectification and these products are designed to be used with International Rectifier Switches and Output Rectifiers which are available in identical package outlines.

	$V_F < 1V @ 10A$
	$I_{FSM} = 200A$
	$V_{RRM} 800 \text{ to } 1200V$

Package Outline

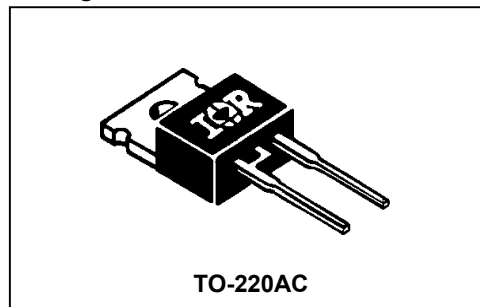

Major Ratings and Characteristics

Characteristics	10ETS..	Units
$I_{F(AV)}$ Sinusoidal waveform	10	A
V_{RRM} Range	800 to 1200	V
I_{FSM}	200	A
$V_F @ 10A, T_J = 25^\circ C$	1.1	V
T_J	-40 to 150	$^\circ C$

Package Outline

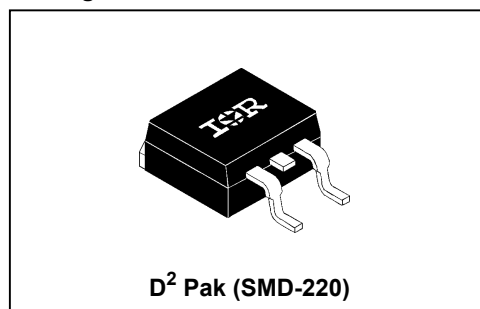

Output Current in Typical Applications

Applications	Single-phase Bridge	Three-phase Bridge	Units
Capacitive input filter $T_A = 55^\circ C, T_J = 125^\circ C$ common heatsink of $1^\circ C/W$	12.0	16.0	A

Voltage Ratings

Part Number	V_{RRM} , maximum peak reverse voltage V	V_{RSM} , maximum non repetitive peak reverse voltage V	I_{RRM} 150°C mA
10ETS08, 10ETS08S	800	900	0.5
10ETS12, 10ETS12S	1200	1300	

Absolute Maximum Ratings

Parameters	10ETS..	Units	Conditions
$I_{F(AV)}$ Max. Average Forward Current	10	A	@ $T_C = 105^\circ\text{C}$, 180° conduction half sine wave
I_{FSM} Max. Peak One Cycle Non-Repetitive Surge Current	170	A	10ms Sine pulse, rated V_{RRM} applied
	200		10ms Sine pulse, no voltage reapplied
I^2t Max. I^2t for fusing	130	A^2s	10ms Sine pulse, rated V_{RRM} applied
	145		10ms Sine pulse, no voltage reapplied
$I^2\sqrt{t}$ Max. $I^2\sqrt{t}$ for fusing	1450	$A^2\sqrt{s}$	t = 0.1 to 10ms, no voltage reapplied

Electrical Specifications

Parameters	10ETS..	Units	Conditions
V_{FM} Max. Forward Voltage Drop	1.1	V	@ 10A, $T_J = 25^\circ\text{C}$
r_t Forward slope resistance	20	mΩ	$T_J = 150^\circ\text{C}$
$V_{F(TO)}$ Threshold voltage	0.82	V	
I_{RM} Max. Reverse Leakage Current	0.05	mA	$T_J = 25^\circ\text{C}$
	0.50		$T_J = 150^\circ\text{C}$

$V_R = \text{rated } V_{RRM}$

Thermal-Mechanical Specifications

Parameters	10ETS..	Units	Conditions
T_J Max. Junction Temperature Range	-40 to 150	°C	
T_{stg} Max. Storage Temperature Range	-40 to 150	°C	
R_{thJC} Max. Thermal Resistance Junction to Case	2.5	°C/W	DC operation
R_{thJA} Max. Thermal Resistance Junction to Ambient (PCB Mount)*	62	°C/W	
T_s Soldering Temperature	240	°C	
wt Approximate Weight	2(0.07)	g(oz.)	
Case Style	TO-220AC, D ² Pak (SMD-220)		

* When mounted on 1" square (650mm²) PCB of FR-4 or G-10 material 4 oz (140µm) copper 40°C/W
For recommended footprint and soldering techniques refer to application note #AN-994

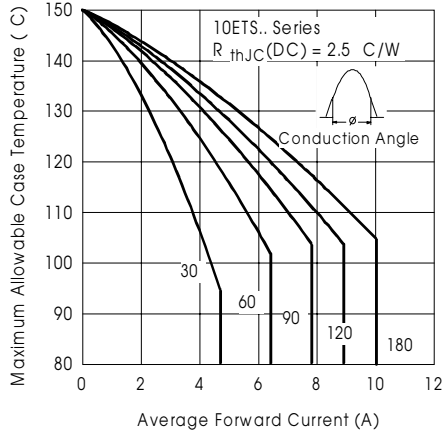

Fig. 1 - Current Rating Characteristics

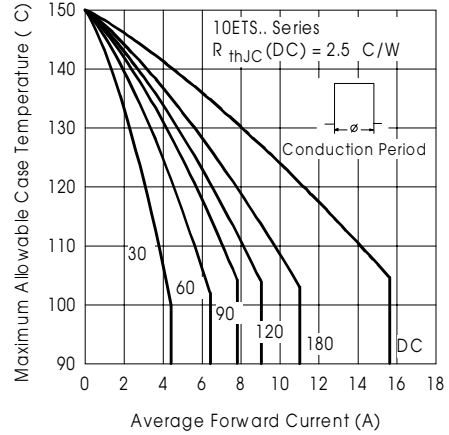

Fig. 2 - Current Rating Characteristics

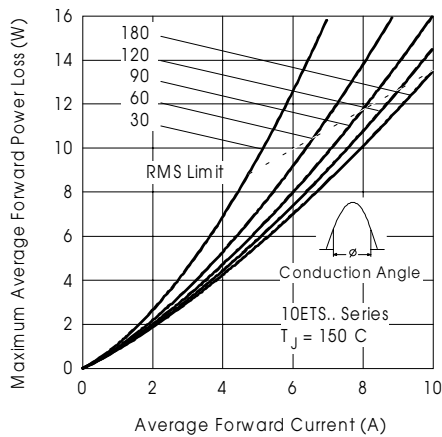

Fig. 3 - Forward Power Loss Characteristics

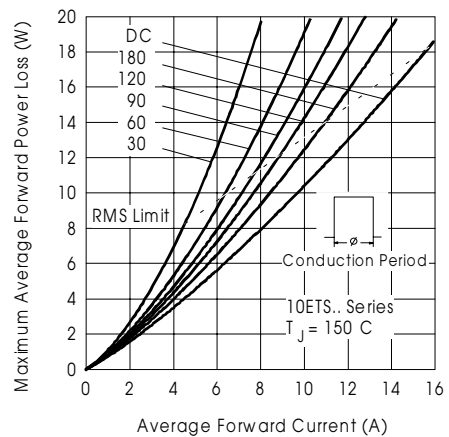

Fig. 4 - Forward Power Loss Characteristics

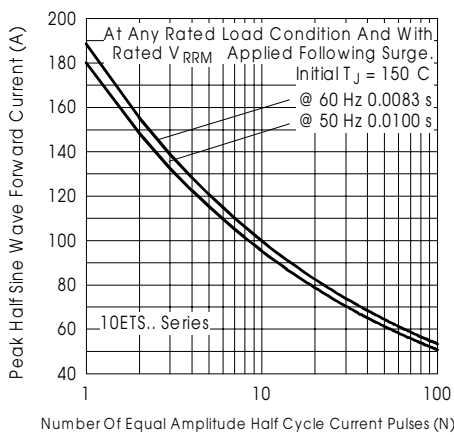

Fig. 5 - Maximum Non-Repetitive Surge Current

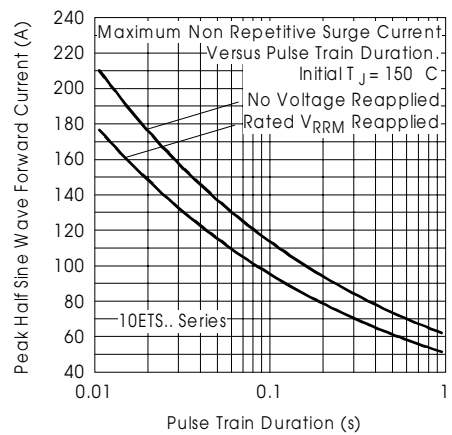

Fig. 6 - Maximum Non-Repetitive Surge Current

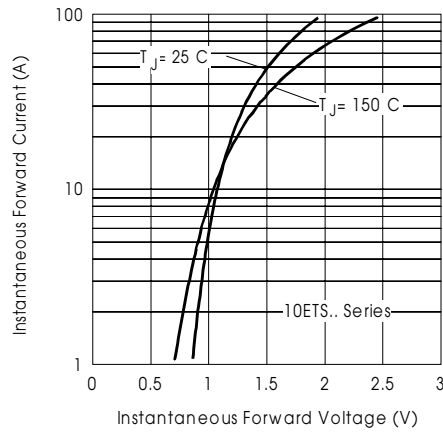

Fig. 8 - Forward Voltage Drop Characteristics

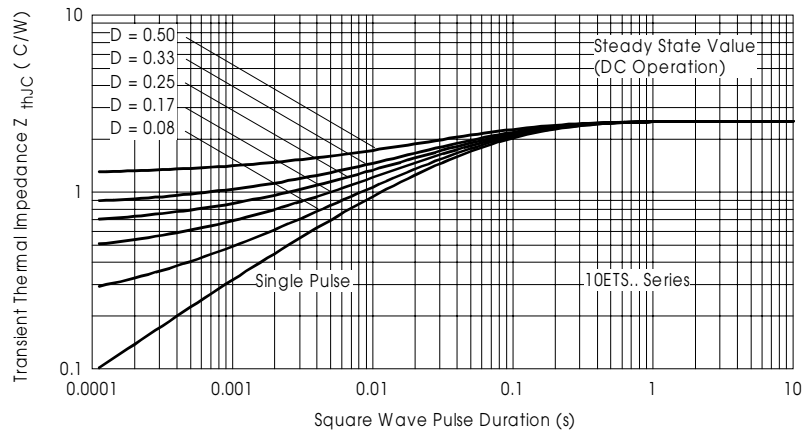
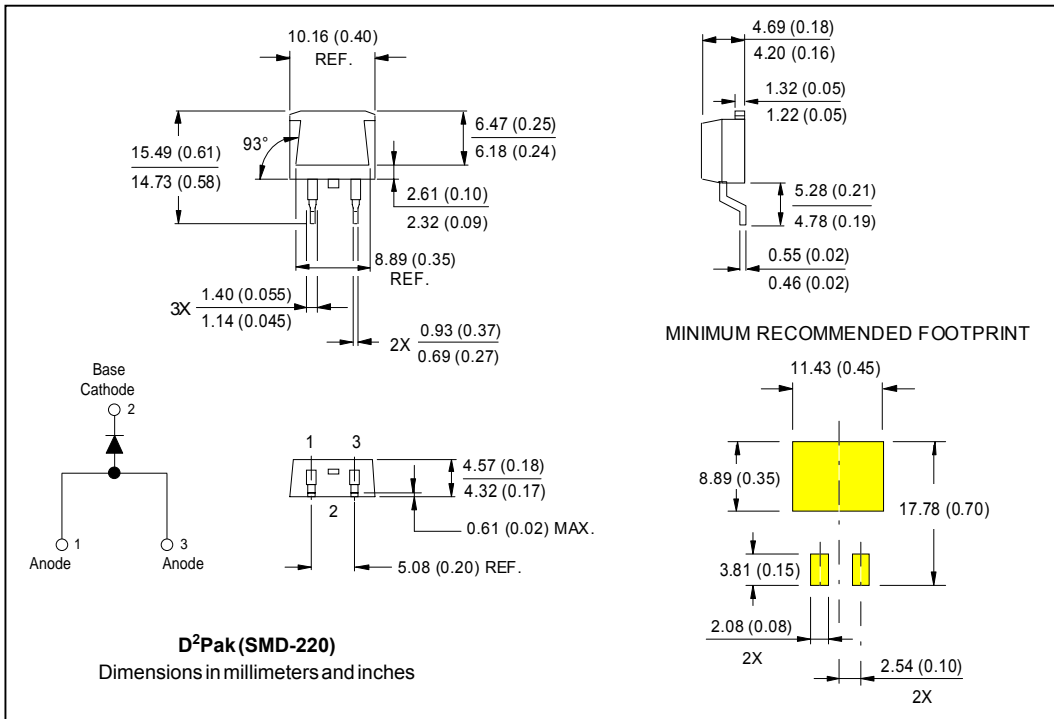
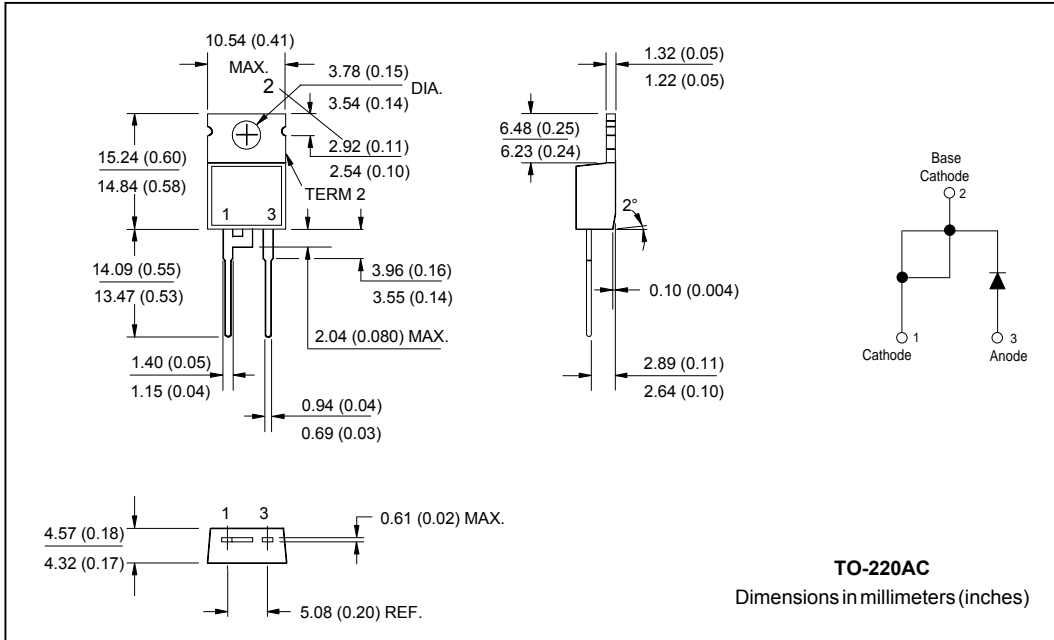
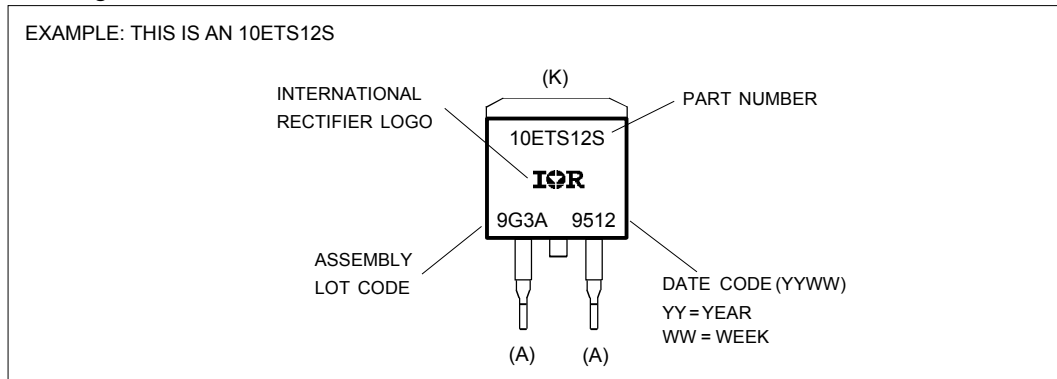

Fig. 9 - Thermal Impedance Z_{thjC} Characteristics

Outline Table



Marking Information



Tape & Reel Information

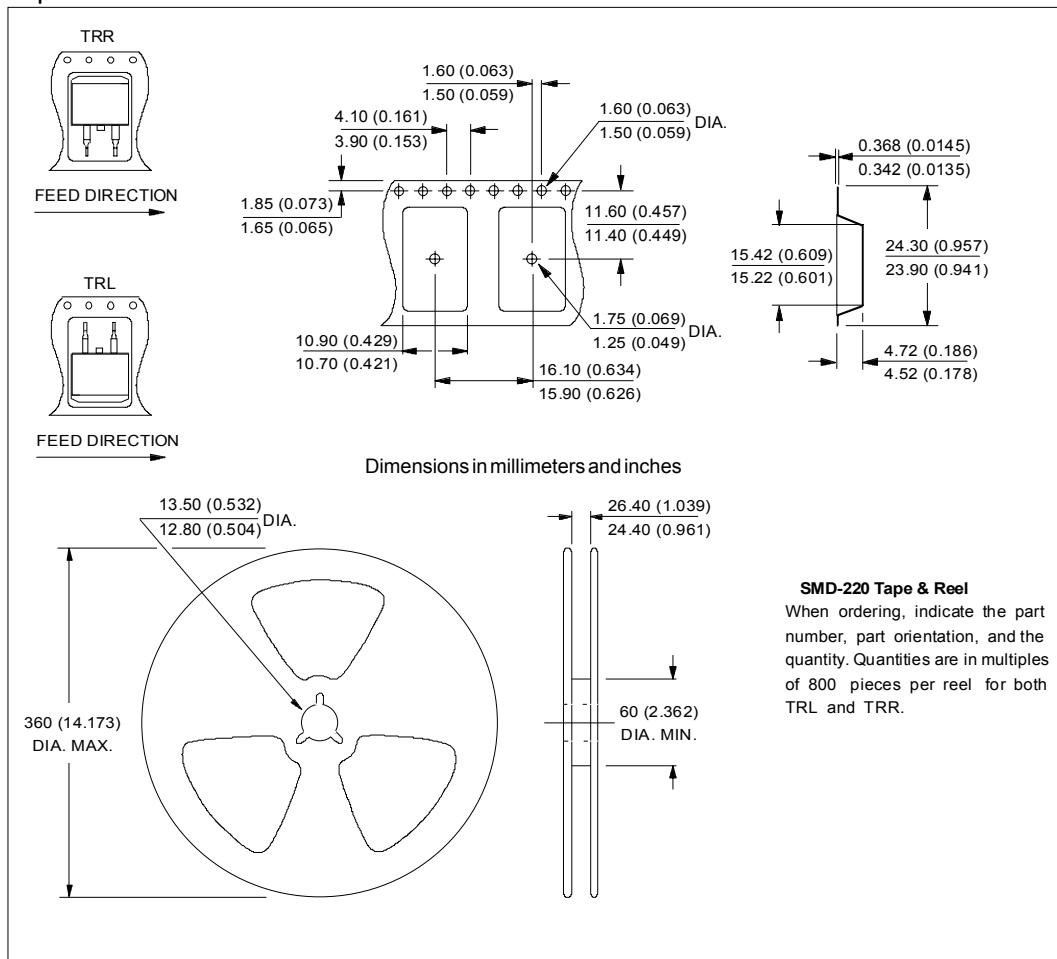

Ordering Information Table

Device Code															
	<table border="1" style="margin: auto;"> <tr> <td style="padding: 5px;">10</td> <td style="padding: 5px;">E</td> <td style="padding: 5px;">T</td> <td style="padding: 5px;">S</td> <td style="padding: 5px;">12</td> <td style="padding: 5px;">S</td> <td style="padding: 5px;">TRL</td> </tr> <tr> <td style="text-align: center;">①</td> <td style="text-align: center;">②</td> <td style="text-align: center;">③</td> <td style="text-align: center;">④</td> <td style="text-align: center;">⑤</td> <td style="text-align: center;">⑥</td> <td style="text-align: center;">⑦</td> </tr> </table>	10	E	T	S	12	S	TRL	①	②	③	④	⑤	⑥	⑦
10	E	T	S	12	S	TRL									
①	②	③	④	⑤	⑥	⑦									
1	- Current Rating														
2	- Circuit Configuration E = Single Diode														
3	- Package T = TO-220AC														
4	- Type of Silicon S = Standard Recovery Rectifier														
5	- Voltage code: Code x 100 = V_{RRM}														
6	- S = TO-220 D ² Pak (SMD-220) Version														
7	- Tape and Reel Option TRL = Left Reel TRR = Right Orientation Reel														

08 = 800V
12 = 1200V

Data and specifications subject to change without notice.
 This product has been designed and qualified for Industrial Level.
 Qualification Standards can be found on IR's Web site.