



XTR501

HIGH CURRENT BRIDGE DRIVER and 4-20mA Transmitter

FEATURES

- SENSOR EXCITATION OF 1W
- VARIABLE EXCITATION VOLTAGE:
1.5V to 5.0V
- SINGLE SUPPLY: 11.4V to 30VDC
- INRUSH CURRENT LIMITING
- 4-20mA TRANSMITTER

APPLICATIONS

- GAS DETECTION SENSORS
- PELLISTOR CATALYTIC DETECTORS
- STRAIN GAGES
- HIGH CURRENT BRIDGES
- LOAD CELLS
- HOT-WIRE ANEMOMETERS

DESCRIPTION

The XTR501 contains a high efficiency DC/DC converter and 4-20mA three wire current transmitter. It provides regulated bridge excitation, optional half bridge, differential inputs and current transmitter necessary for the excitation and signal conditioning of low impedance bridge sensors and high integrity signal transmission.

The DC/DC converter is capable of supplying 1W into a regulated bridge voltage of 1.5V to 5.0V from a supply of 11.4V to 30V. The combination of a low startup current and high efficiency current step-up allows for a combined supply line resistance of up to 100Ω when exciting low impedance sensors.

The instrumentation amplifier of the current transmitter can be used over a wide range of gains, accommodating a variety of input signals and sensors.

The XTR501 is particularly suited to excitation of high current/low impedance sensors used in bridge applications allowing the use of lighter cabling leading to considerable savings on cabling costs.

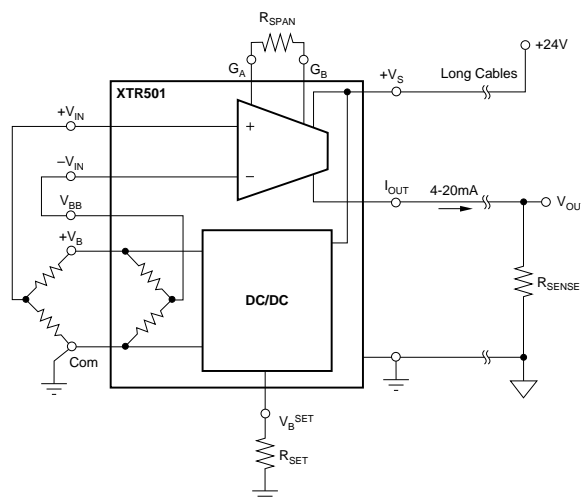

International Airport Industrial Park • Mailing Address: PO Box 11400 • Tucson, AZ 85734 • Street Address: 6730 S. Tucson Blvd. • Tucson, AZ 85706
Tel: (520) 746-1111 • Twx: 910-952-1111 • Cable: BBRCORP • Telex: 066-6491 • FAX: (520) 889-1510 • Immediate Product Info: (800) 548-6132

SPECIFICATIONS

ELECTRICAL

T_A = +25°C, V_S = 24V, V_{BRIDGE} = 2V, I_{LOAD} = 300mA unless otherwise specified.

PARAMETER	CONDITIONS	XTR501			UNITS
		MIN	TYP	MAX	
INSTRUMENTATION AMPLIFIER/CURRENT TRANSMITTER					
SIGNAL OUTPUT					
Output Current Equation	R _G in Ω, V _{IN} in V	$I_O = 0.004 + 0.016 [(1 + 50k\Omega/R_G)/4.94] V_{IN}$			A
Output Current	Linear Operating Range	4		20	mA
Over-scale Limit		25	27		mA
Under-scale Limit			0		mA
ZERO					
Output Current			4		mA
Offset Error			±50	±100	μA
vs Temperature			0.2		μA/°C
vs Supply Voltage	V _S = 11.4V to 30V		0.5	2	μA/V
SPAN					
Span Equation	R _G in Ω, V _{IN} in V	Span = 0.016[(1 + 50kΩ/R _G)/4.94]			A/V
Untrimmed Error	G = 1		±0.2	±2.5	%
vs Temperature	G = 250		±1.5	±10	%
Nonlinearity	G = 1, I _O = 4mA to 20mA		50	±0.025	ppm/°C
INPUT					
Common-Mode Range		0		4.94 ⁽¹⁾	V
Offset Voltage			16		mV
vs Temperature			50		μV/°C
vs Supply Voltage			75		dB
Common-Mode Rejection			85		dB
Impedance; Differential, Common-Mode			10 ¹⁰ 6		Ω pF
DC/DC CONVERTER					
BRIDGE EXCITATION VOLTAGE SOURCE					
Output Voltage	V _{IN} = 0V, G = 1	1.5		5	V
vs Temperature			200		ppm/°C
vs Long Term Stability			100		ppm/1000hrs
Output Power				1	W
Line Voltage Regulation	V _S = 11.4V to 30.0V		0.25		%
Load Voltage Regulation	Load Current 160mA to 340mA		0.25		%
Output Voltage Ripple	Load Voltage 2V Load Current 300mA Load Voltage 2V		150		mV
Output Voltage Ripple Frequency			100		kHz
Output Short-Circuit Current	Limited Duration		2.6		A
Input Current	Output Short-Circuit		150		mA
POWER SUPPLY					
Supply Voltage, V _S		11.4	24	30	V
Supply Current			See Typical Curve		
TEMPERATURE					
Operating		-40		+70	°C
Storage		-40		+85	°C

NOTE: (1) Common-Mode Range is based on a multiple of a bandgap reference of 1.235V.

The information provided herein is believed to be reliable; however, BURR-BROWN assumes no responsibility for inaccuracies or omissions. BURR-BROWN assumes no responsibility for the use of this information, and all use of such information shall be entirely at the user's own risk. Prices and specifications are subject to change without notice. No patent rights or licenses to any of the circuits described herein are implied or granted to any third party. BURR-BROWN does not authorize or warrant any BURR-BROWN product for use in life support devices and/or systems.

ABSOLUTE MAXIMUM RATINGS

Supply Voltage, V_S	30V
Input Voltage	10V
Output Power	1W
Operating Temperature Range	0°C to +70°C
Storage Temperature Range	-40°C to +85°C

PIN CONFIGURATION

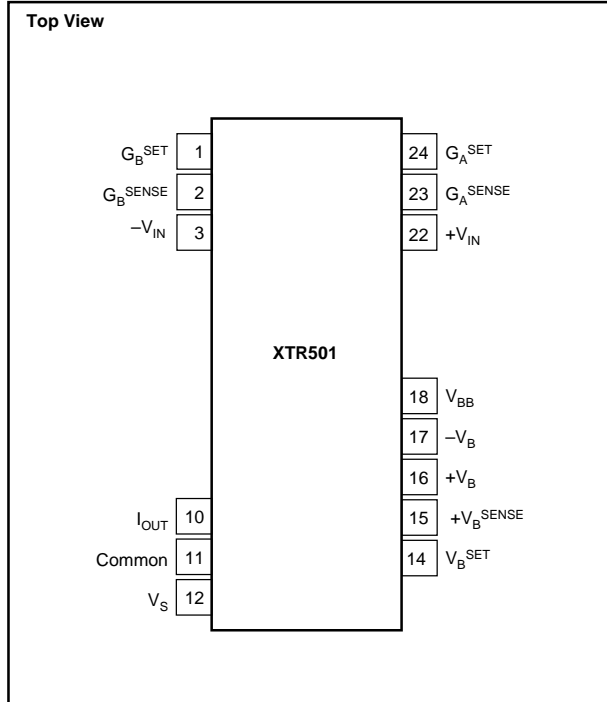

ORDERING INFORMATION

MODEL	PACKAGE	TEMPERATURE RANGE
XTR501	24-Pin Plastic Module	-40°C to +70°C

PACKAGE INFORMATION

MODEL	PACKAGE	PACKAGE DRAWING NUMBER ⁽¹⁾
XTR501	24-Pin Plastic Module	902

NOTE: (1) For detailed drawing and dimension table, please see end of data sheet, or Appendix D of Burr-Brown IC Data Book.

PIN DESCRIPTION

PIN	NAME	DESCRIPTION
1	G_B^{SET}	Connect to R_{SPAN} to set transconductance.
2	G_B^{SENSE}	Sense pin for G_B^{SET} connect to G_A^{SET} .
3	$-V_{IN}$	Inverting input to transmitter.
10	I_{OUT}	Output Current connect through R_{SENSE} to common.
11	Common	Supply return for sense and V_B connectors.
12	V_S	Supply to XTR501 +11.4V to 30.0V.
14	V_B^{SET}	Single resistor to common sets the bridge excitation voltage.
15	$+V_B^{SENSE}$	Positive bridge sense input connect to positive excitation voltage at bridge.
16	$+V_B$	Positive bridge excitation voltage.
17	$-V_B$	Negative bridge excitation voltage.
18	V_{BB}	Output from internal half bridge connect to $-V_{IN}$.
22	$+V_{IN}$	Non-Inverting input to transmitter.
23	G_A^{SENSE}	Sense pin for G_A^{SET} connect to G_A^{SET} .
24	G_A^{SET}	Connect to R_{SPAN} to set transconductance.

TYPICAL PERFORMANCE CURVES

$T_A = +25^\circ\text{C}$, $V_S = 24\text{V}$, $V_{\text{BRIDGE}} = 2\text{V}$, $I_{\text{LOAD}} = 300\text{mA}$ unless otherwise specified.

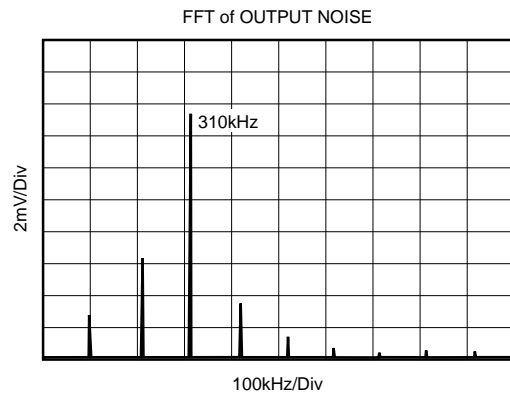
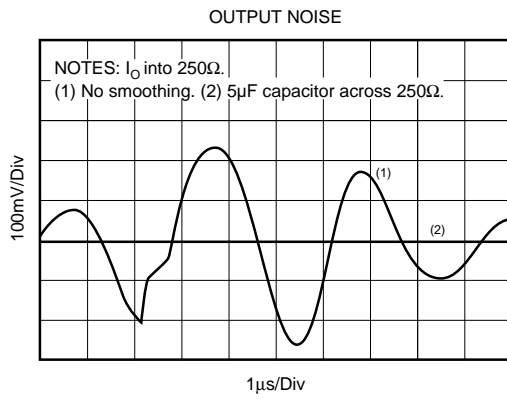
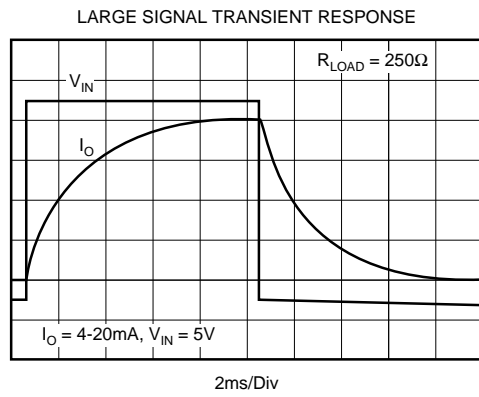
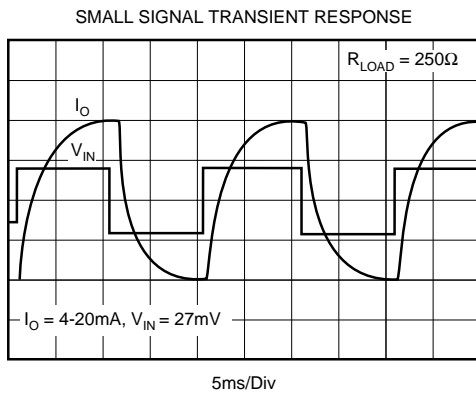
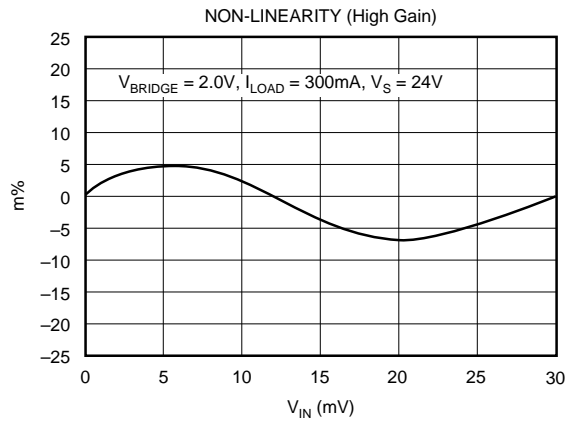
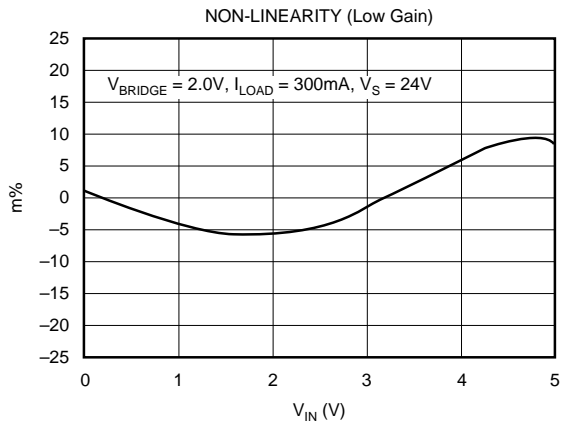

TYPICAL PERFORMANCE CURVES (CONT)

$T_A = +25^\circ\text{C}$, $V_S = 24\text{V}$, $V_{\text{BRIDGE}} = 2\text{V}$, $I_{\text{LOAD}} = 300\text{mA}$ unless otherwise specified.

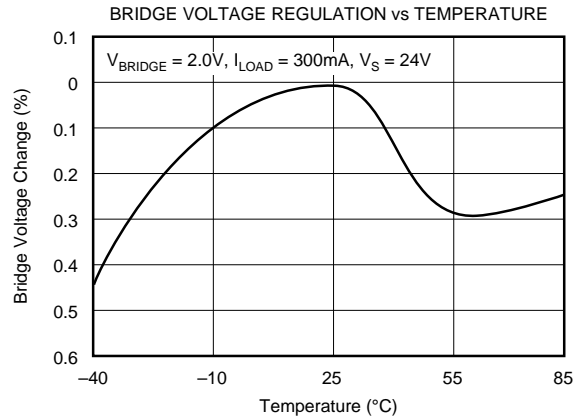
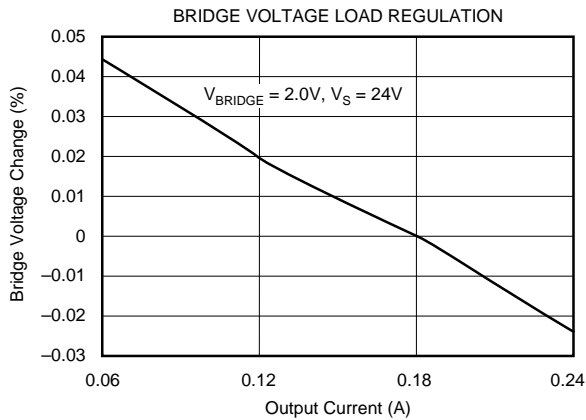
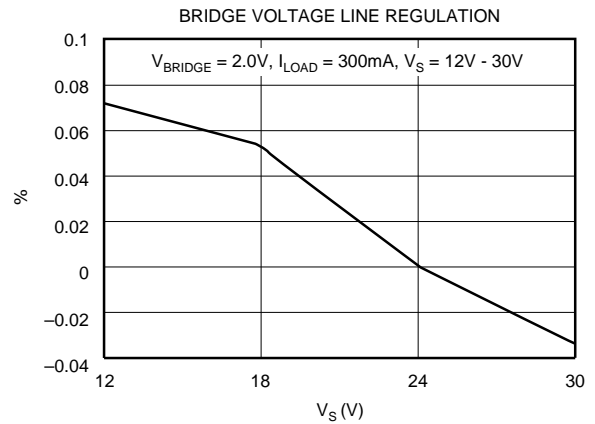
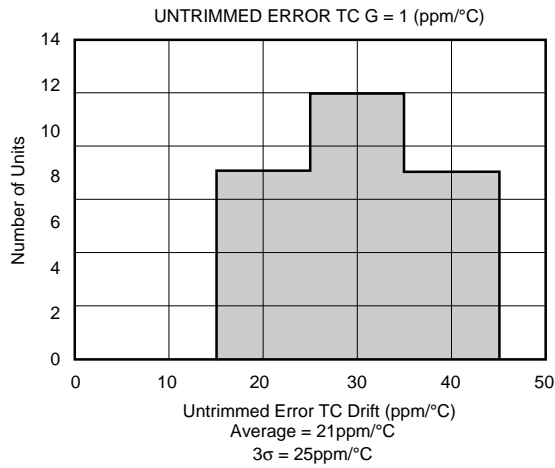
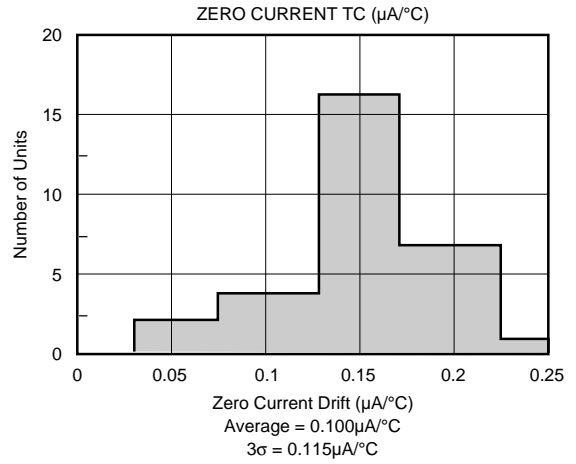
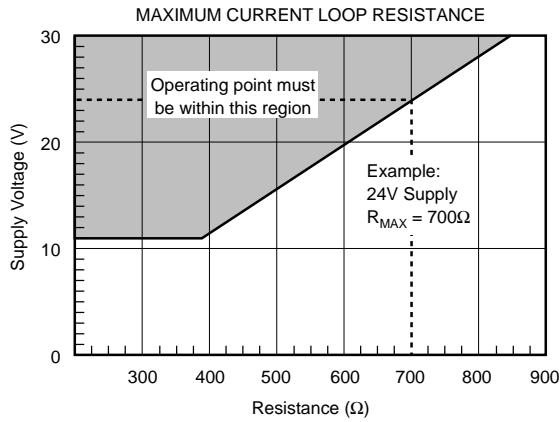

TYPICAL PERFORMANCE CURVES (CONT)

$T_A = +25^\circ\text{C}$, $V_S = 24\text{V}$, $V_{\text{BRIDGE}} = 2\text{V}$, $I_{\text{LOAD}} = 300\text{mA}$ unless otherwise specified.

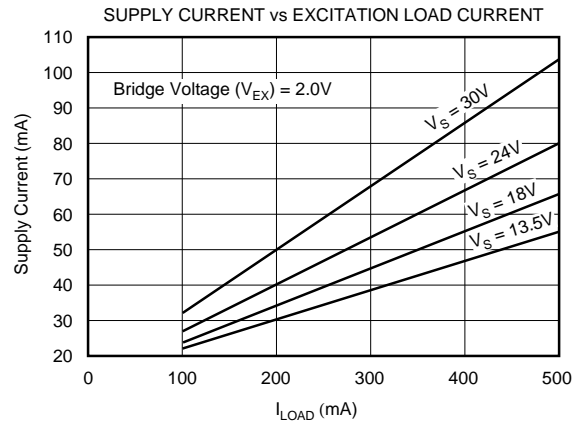
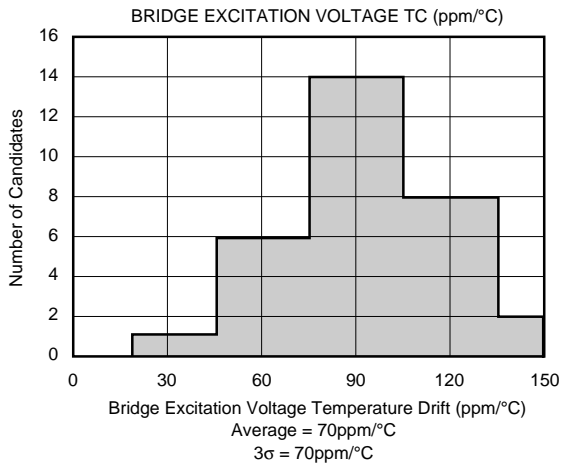

METHOD OF OPERATION

The XTR501 consists of a high efficiency DC/DC converter with current and voltage mode control and a current loop transmitter.

The pulse-width modulation controller monitors the current and voltage control signals and varies the conduction period to regulate the bridge excitation voltage, V_B .

A soft-start feature is provided to negate problems caused by high in-rush currents and lead resistances, thus allowing the XTR501 to be driven through cables of up to 100Ω of supply line resistance with no reduction in performance.

A single resistor, R_{SET} , determines the regulated bridge excitation voltage which may be in the range 1.5V to 5.0V.

The gain of the transconductance amplifier, which forms the current loop transmitter, is again determined by a single resistor R_{SPAN} and allows input voltages from 25mV to drive the 4-20mA current loop.

APPLICATIONS

The XTR501 is designed to be used with a wide range of pellistor catalytic gas detectors. The pellistor gas detector consists of a matched pair of elements; an active bead which is the sensing element, and an inactive bead which is the compensating element. These elements form one side of a Wheatstone bridge arrangement. The bridge serves a dual purpose: to raise the temperature of the elements to about 500°C , which is their working temperature, and to allow detection of the presence of combustible gases through imbalance of the bridge. This happens as the pellistor increases temperature due to oxidation of the flammable gas and thus increases its resistance.

In general, pellistor catalytic gas detectors are limited in use to monitoring up to 100% of the LEL (lower explosive limit). Beyond this point ambiguous results can occur due to the inability of the pellistor to oxidize the gas as the available oxygen decreases (see Figure 3).

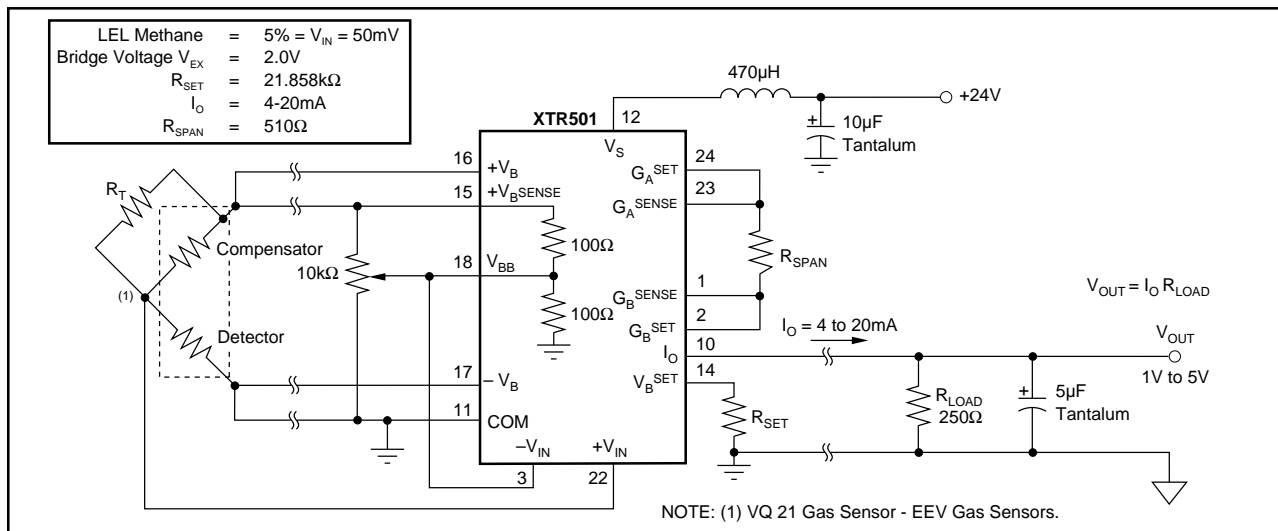

FIGURE 1. Basic Connection

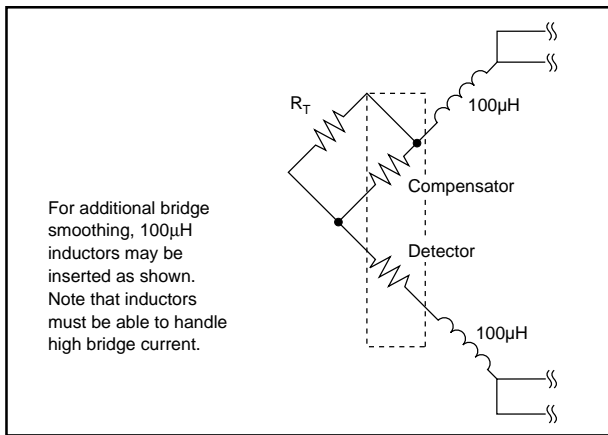

FIGURE 2. Bridge Smoothing.

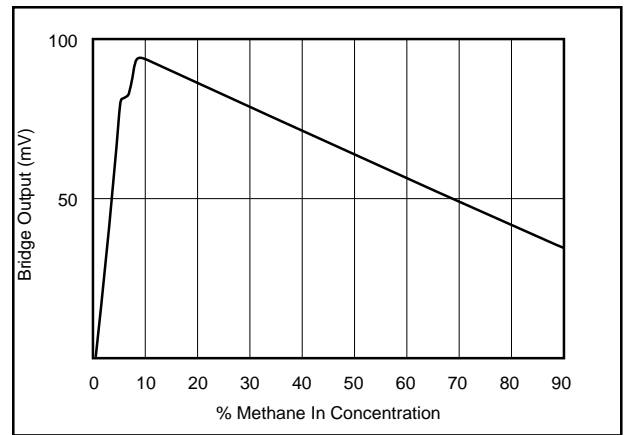

FIGURE 3. Typical Pellistor Response.

An interesting feature of pellistor elements, and those tested in the applications, is that they create a similar bridge output at LEL for almost all hydrocarbons. This feature allows a comparative measurement to be made of one gas when an instrument has been calibrated for another.

e.g. Instrument calibrated for Methane (K=112) measuring Hydrogen (K=85.8).

Actual % of LEL will be 1.31 x meter reading. (112/85.8).

This is an approximation and it is recommended that for exact conversions the instrument should be calibrated using the relevant gases.

Tables of these constants can be sourced through the manufacturers of gas sensing products.

An example of the XTR501 used with a pellistor catalytic gas detector is shown in Figure 1.

To Calculate R_{SET}

See Figure 4. Point (a) will be maintained at 1.235V.

$$\frac{V_B - 1.235}{10k\Omega} = \frac{1.235 (50k\Omega + R_{SET})}{R_{SET} 50k\Omega}$$

$$\frac{50k\Omega (V_B - 1.235)}{(10k\Omega) (1.235)} = \frac{50k\Omega + R_{SET}}{R_{SET}}$$

$$= 1 + \frac{50k\Omega}{R_{SET}}$$

$$\frac{5 (V_B - 1.235)}{1.235} - 1 = \frac{50k\Omega}{R_{SET}}$$

$$R_{SET} = \frac{(50k\Omega) (1.235)}{5 (V_B - 1.235) - 1.235}$$

Example:

V_B	R_{SET} Calculated
1.5	Open
2.0	21.858k Ω
3.0	7.891k Ω
4.0	4.815k Ω
5.0	3.464k Ω

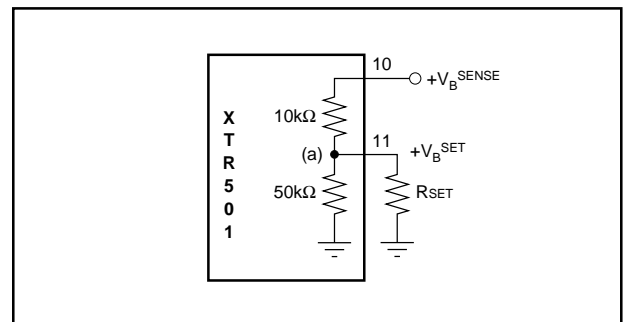

FIGURE 4. Internal Circuit $+V_B^{SET}$.

To Calculate R_{SPAN}

$$I_O = 0.004 + 0.016 \left(\frac{1 + 50k\Omega / R_{SPAN}}{4.94} \right) V_{IN}$$

For $V_{IN} = 10mV$ and $I_O = 20mA$

$$0.02 = 0.004 + 0.016 \left(\frac{1 + 50k\Omega / R_{SPAN}}{4.94} \right) 0.01$$

$$\frac{0.016}{(0.016)(0.01)} = \frac{1 + (50k\Omega / R_{SPAN})}{4.94}$$

$$494 = 1 + 50k\Omega / R_{SPAN}$$

$$R_{SPAN} = \frac{50k\Omega}{493}$$

$$= 101.4$$

i.e

$$\frac{4.94}{V_{IN}} = 1 + \frac{50k\Omega}{R_{SPAN}}$$

$$R_{SPAN} = \frac{50k\Omega}{\frac{4.94}{V_{IN}} - 1}$$

MECHANICAL

Package Number 902 — 24-Pin Plastic

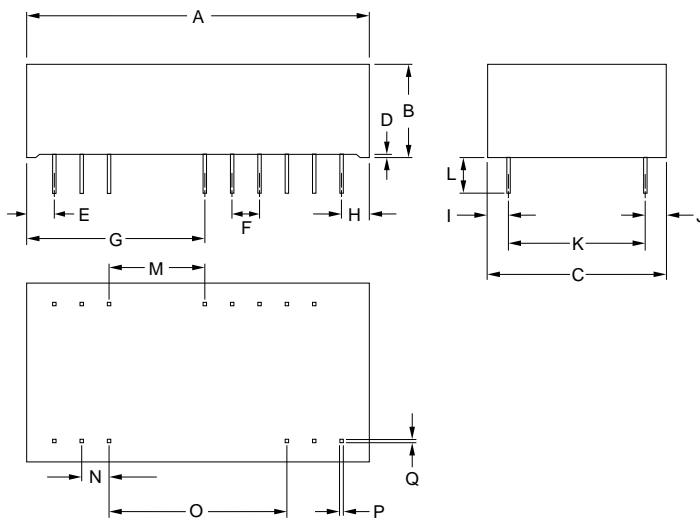

DIM	INCHES		MILLIMETERS	
	MIN	MAX	MIN	MAX
A	2.505		63.63	
B	.681		17.30	
C	1.306		33.17	
D	.024		0.60	
E	.202		5.14	
F	.200		5.08	
G	1.302		33.08	
H	.203		5.15	
I	.153		3.885	
J	.153		3.885	
K	1.000		25.40	
L	.256		6.50	
M	.700		17.78	
N	.200		5.08	
O	1.300		33.02	
P	.025		0.64	
Q	.025		0.64	