

TENTATIVE TOSHIBA Photocoupler GaAs Ired & Photo-Transistor

TLP320, TLP320-2, TLP320-4

Telecommunication
Office Machine
Telephone Use Equipment

The TOSHIBA TLP320, -2 and -4 consists of a photo-transistor optically coupled to a gallium arsenide infrared emitting diode. The TLP320-2 offers two isolated channels in an eight lead plastic DIP package, while the TLP320-4 provides four isolated channels in a sixteen plastic DIP package. This is suitable for application of AC input current up to 150mA.

- I_F maximum rating: ±150mA
- Collector-emitter voltage: 55V (min.)
- Current transfer ratio: 25% (min.) (I_F = 20mA)
- Isolation voltage: 5000V_{rms} (min.)
- UL recognized: file No. E67349

Pin Configurations (top view)

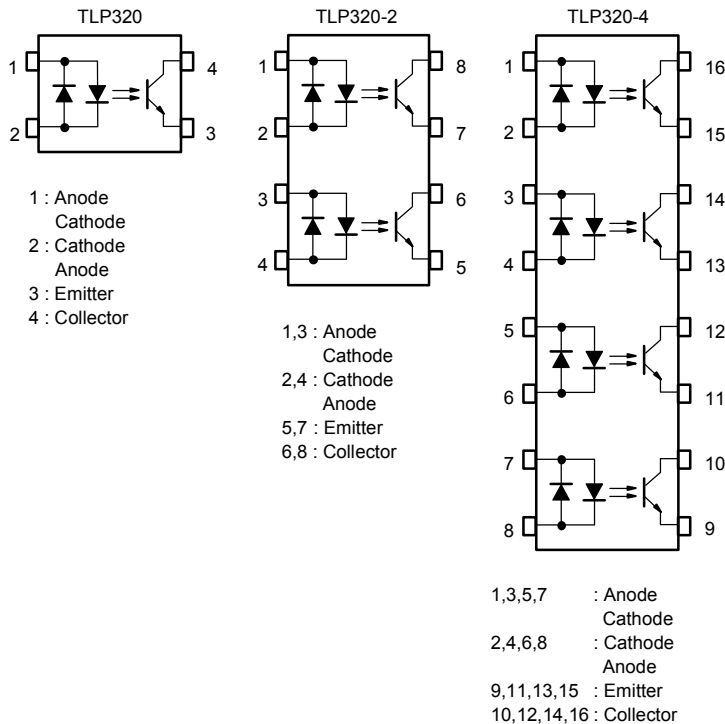

Unit in mm

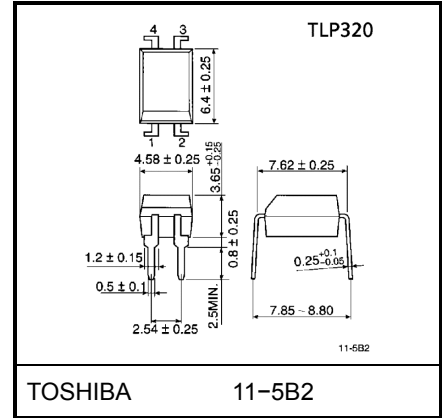

Weight: 0.26g

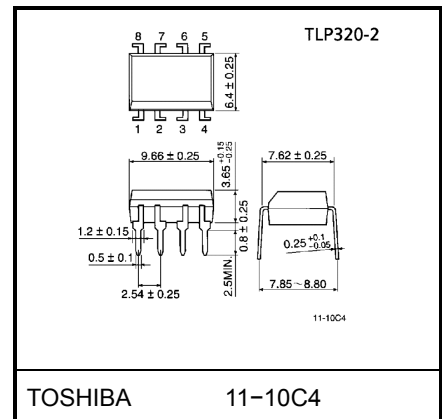

Weight: 0.54g

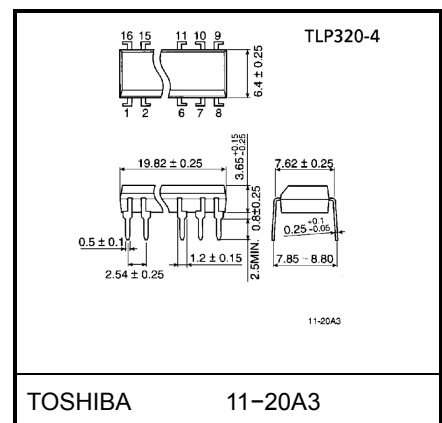

Weight: 1.1g

Maximum Ratings (Ta = 25°C)

Characteristic	Symbol	Rating		Unit
		TLP320	TLP320-2 TLP320-4	
LED	Forward current	±150		mA
	Forward current derating	-1.5 (Ta ≥ 25°C)		mA / °C
	Pulse forward current	±1 (100µs pulse, 100pps)		A
	Junction temperature	125		°C
Detector	Collector-emitter voltage	55		V
	Emitter-collector voltage	7		V
	Collector current	80		mA
	Collector power dissipation (1 circuit)	150	100	mW
	Collector power dissipation derating (1 circuit, Ta ≥ 25°C)	-1.5	-1.0	mW / °C
	Junction temperature	125		°C
Storage temperature range	T _{stg}	-55~125		°C
Operating temperature range	T _{opr}	-55~100		°C
Lead soldering temperature	T _{sol}	260 (10s)		°C
Total package power dissipation	P _T	250	200	mW
Total package power dissipation derating (Ta ≥ 25°C)	ΔP _T / °C	-2.5	2.0	mW / °C
Isolation voltage (Note 1)	BV _S	5000 (AC, 1min., R.H. ≤ 60%)		V _{rms}

(Note 1) Device consider a two terminal: LED side pins shorted together and detector side pins shorted together.

Recommended Operating Conditions

Characteristic	Symbol	Min.	Typ.	Max.	Unit
Supply voltage	V _{CC}	—	5	24	V
Forward current	I _F	—	20	120	mA
Collector current	I _C	—	1	10	mA
Operating temperature	T _{opr}	-25	—	85	°C

Individual Electrical Characteristics (Ta = 25°C)

Characteristic		Symbol	Test Condition	Min.	Typ.	Max.	Unit
LED	Forward voltage	V_F	$I_F = \pm 100 \text{ mA}$	—	1.4	1.7	V
	Forward current	I_F	$V_F = \pm 0.7 \text{ V}$	—	2.5	20	μA
	Capacitance	C_T	$V = 0, f = 1 \text{ MHz}$	—	60	—	pF
Detector	Collector-emitter breakdown voltage	$V_{(BR)CEO}$	$I_C = 0.5 \text{ mA}$	55	—	—	V
	Emitter-collector breakdown voltage	$V_{(BR)ECO}$	$I_E = 0.1 \text{ mA}$	7	—	—	V
	Collector dark current	I_{CEO}	$V_{CE} = 24 \text{ V}$	—	10	100	nA
			$V_{CE} = 24 \text{ V}, T_a = 85^\circ\text{C}$	—	2	50	μA
Capacitance collector to emitter	C_{CE}	$V = 0, f = 1 \text{ MHz}$	—	10	—	pF	

Coupled Electrical Characteristics (Ta = 25°C)

Characteristic	Symbol	Test Condition	Min.	Typ.	Max.	Unit
Current transfer ratio	I_C / I_F	$I_F = \pm 20 \text{ mA}, V_{CE} = 1 \text{ V}$	25	—	—	%
	I_C / I_F (high)	$I_F = \pm 100 \text{ mA}, V_{CE} = 1 \text{ V}$	20	—	80	
Collector-emitter saturation voltage	$V_{CE}(\text{sat})$	$I_C = 2.4 \text{ mA}, I_F = \pm 20 \text{ mA}$	—	—	0.4	V
		$I_C = 2.4 \text{ mA}, I_F = \pm 100 \text{ mA}$	—	—	0.4	
Off-state collector current	$I_{C(\text{off})}$	$V_F = \pm 0.7 \text{ V}, V_{CE} = 24 \text{ V}$	—	1	10	μA
CTR symmetry (Note)	I_C (ratio)	$I_C (I_F = -20\text{mA}) / I_C (I_F = +20\text{mA})$ (Note)	0.5	1	2	—

Isolation Characteristics (Ta = 25°C)

Characteristic	Symbol	Test Condition	Min.	Typ.	Max.	Unit
Capacitance input to output	C_S	$V_S = 0, f = 1 \text{ MHz}$	—	0.8	—	pF
Isolation resistance	R_S	$V_S = 500 \text{ V}, \text{R.H.} \leq 60\%$	5×10^{10}	10^{14}	—	Ω
Isolation voltage	BV_S	AC, 1 minute	5000	—	—	V_{rms}
		AC, 1 second, in oil	—	10000	—	
		DC, 1 minute, in oil	—	10000	—	V_{dc}

(Note)

$$I_C(\text{ratio}) = \frac{I_{C2}(I_F = I_{F2}, V_{CE} = 1\text{V})}{I_{C1}(I_F = I_{F1}, V_{CE} = 1\text{V})}$$

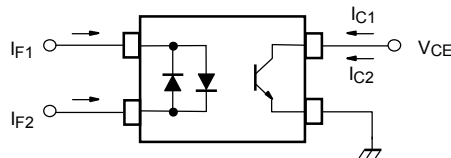

Switching Characteristics (Ta = 25°C)

Characteristic	Symbol	Test Condition	Min.	Typ.	Max.	Unit
Rise time	t_r	$V_{CC} = 10\text{ V}, I_C = 2\text{ mA}$ $R_L = 100\Omega$	—	2	—	μs
Fall time	t_f		—	3	—	
Turn-on time	t_{on}		—	3	—	
Turn-off time	t_{off}		—	3	—	
Turn-on time	t_{ON}	$R_L = 1.9\text{ k}\Omega$ (Fig.1) $V_{CC} = 5\text{ V}, I_F = \pm 16\text{ mA}$	—	2	—	μs
Storage time	t_s		—	15	—	
Turn-off time	t_{OFF}		—	25	—	

Fig. 1 Switching time test circuit

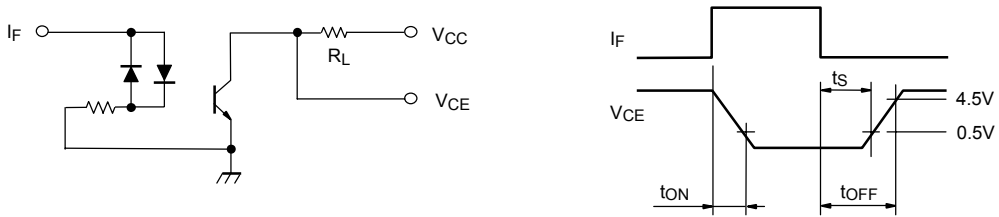

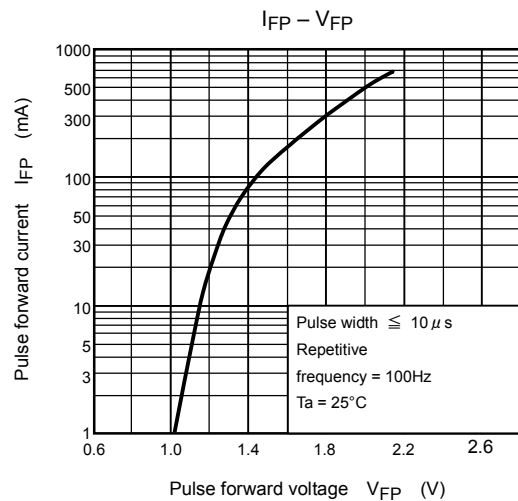
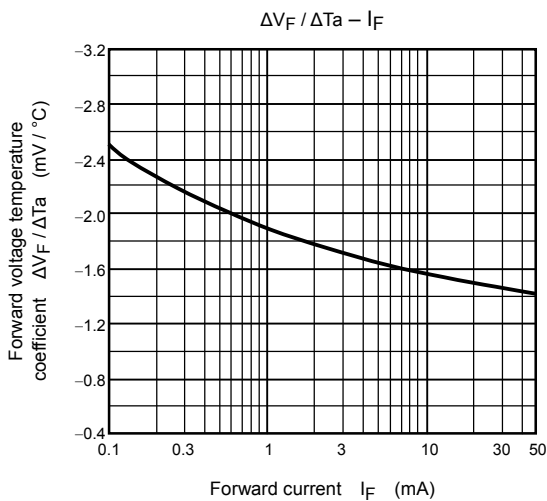
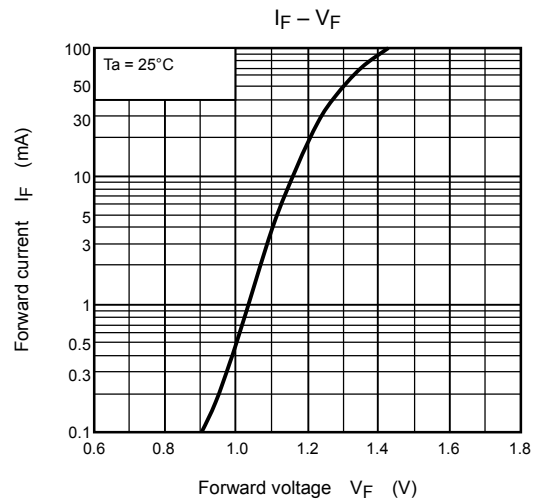
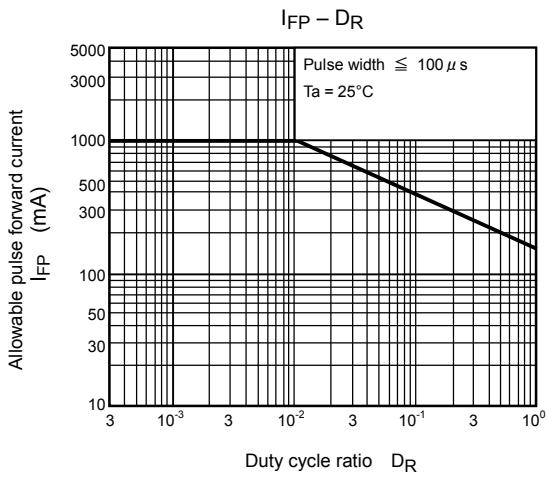
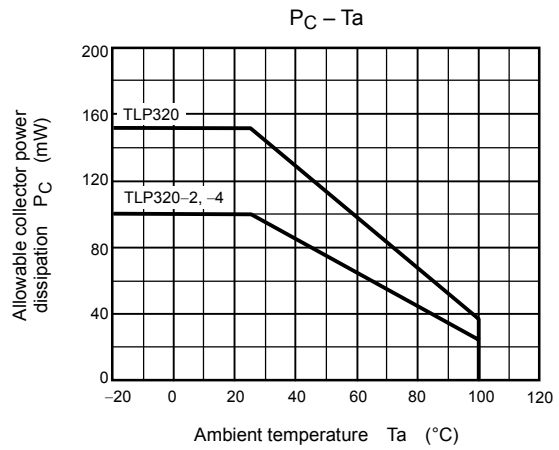
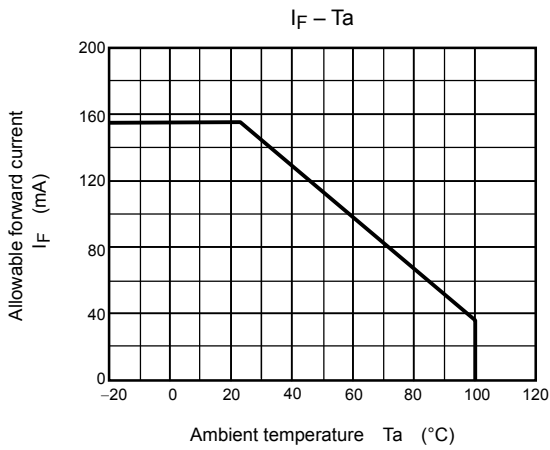

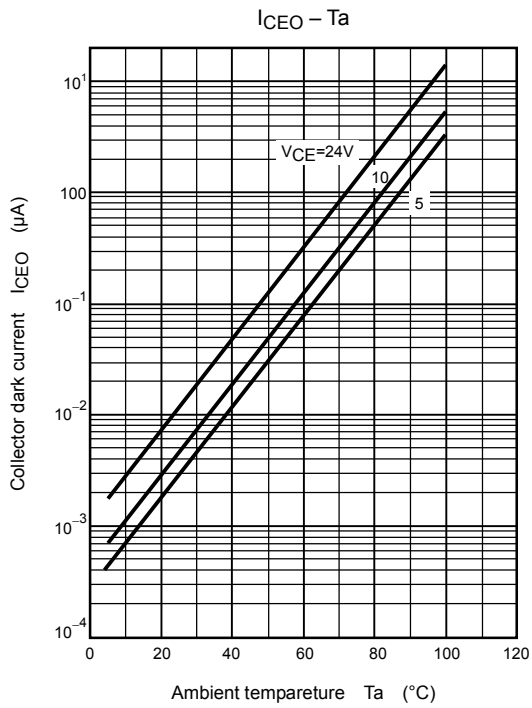
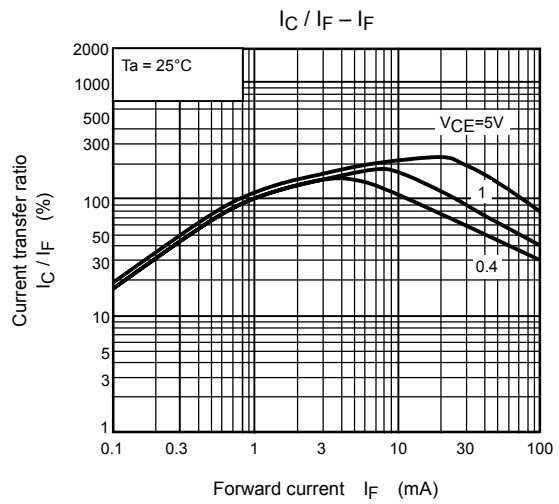
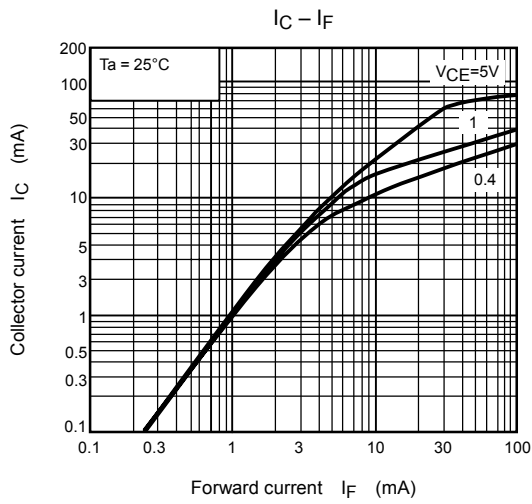

RESTRICTIONS ON PRODUCT USE

000707EBC

- TOSHIBA is continually working to improve the quality and reliability of its products. Nevertheless, semiconductor devices in general can malfunction or fail due to their inherent electrical sensitivity and vulnerability to physical stress. It is the responsibility of the buyer, when utilizing TOSHIBA products, to comply with the standards of safety in making a safe design for the entire system, and to avoid situations in which a malfunction or failure of such TOSHIBA products could cause loss of human life, bodily injury or damage to property.
In developing your designs, please ensure that TOSHIBA products are used within specified operating ranges as set forth in the most recent TOSHIBA products specifications. Also, please keep in mind the precautions and conditions set forth in the "Handling Guide for Semiconductor Devices," or "TOSHIBA Semiconductor Reliability Handbook" etc..
- The TOSHIBA products listed in this document are intended for usage in general electronics applications (computer, personal equipment, office equipment, measuring equipment, industrial robotics, domestic appliances, etc.). These TOSHIBA products are neither intended nor warranted for usage in equipment that requires extraordinarily high quality and/or reliability or a malfunction or failure of which may cause loss of human life or bodily injury ("Unintended Usage"). Unintended Usage include atomic energy control instruments, airplane or spaceship instruments, transportation instruments, traffic signal instruments, combustion control instruments, medical instruments, all types of safety devices, etc.. Unintended Usage of TOSHIBA products listed in this document shall be made at the customer's own risk.
- Gallium arsenide (GaAs) is a substance used in the products described in this document. GaAs dust and fumes are toxic. Do not break, cut or pulverize the product, or use chemicals to dissolve them. When disposing of the products, follow the appropriate regulations. Do not dispose of the products with other industrial waste or with domestic garbage.
- The products described in this document are subject to the foreign exchange and foreign trade laws.
- The information contained herein is presented only as a guide for the applications of our products. No responsibility is assumed by TOSHIBA CORPORATION for any infringements of intellectual property or other rights of the third parties which may result from its use. No license is granted by implication or otherwise under any intellectual property or other rights of TOSHIBA CORPORATION or others.
- The information contained herein is subject to change without notice.