



TDA7443D

TONE CONTROL AND SURROUND DIGITALLY CONTROLLED AUDIO PROCESSOR WITH AGC

PRODUCT PREVIEW

- INPUT MULTIPLEXER
 - 5 STEREO INPUTS
 - SELECTABLE INPUT GAIN FOR OPTIMAL ADAPTATION TO DIFFERENT SOURCES
- ONE STEREO OUTPUT
- AGC
- TREBLE AND BASS CONTROL IN 2.0dB STEPS
- VOLUME CONTROL IN 1.0dB STEPS
- TWO SPEAKER ATTENUATORS:
 - TWO INDEPENDENT SPEAKER CONTROL IN 1.0dB STEPS FOR BALANCE FACILITY
 - INDEPENDENT MUTE FUNCTION
- TWO SURROUND MODES AVAILABLE
 - MUSIC
 - PSEUDO STEREO
- ALL FUNCTION ARE PROGRAMMABLE VIA SERIAL BUS

DESCRIPTION

The TDA7443D is a volume tone (bass and treble)

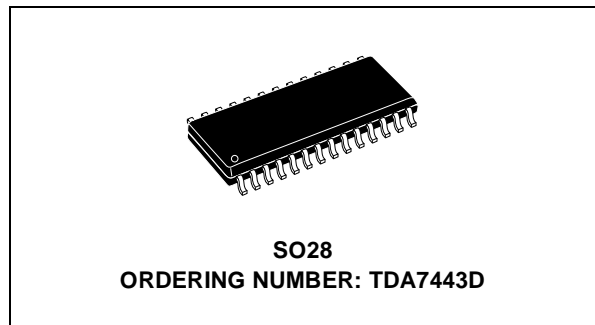

balance (Left/Right) processor for quality audio applications in Hi-Fi systems.

Selectable input gain is provided. Control of all the functions is accomplished by serial bus.

The AC signal setting is obtained by resistor networks and switches combined with operational amplifiers.

Thanks to the used BIPOLAR/CMOS Technology, Low Distortion, Low Noise and DC stepping are obtained.

PIN CONNECTION (Top view)

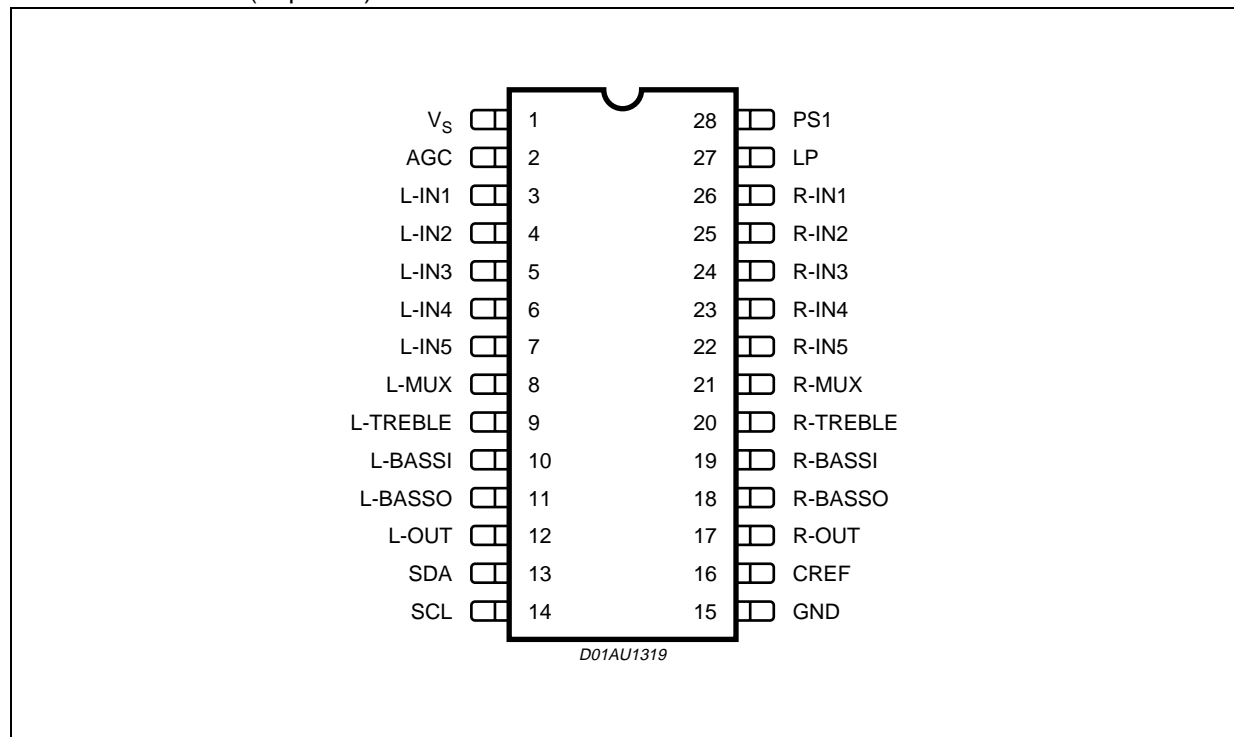

BLOCK DIAGRAM & TEST CIRCUIT

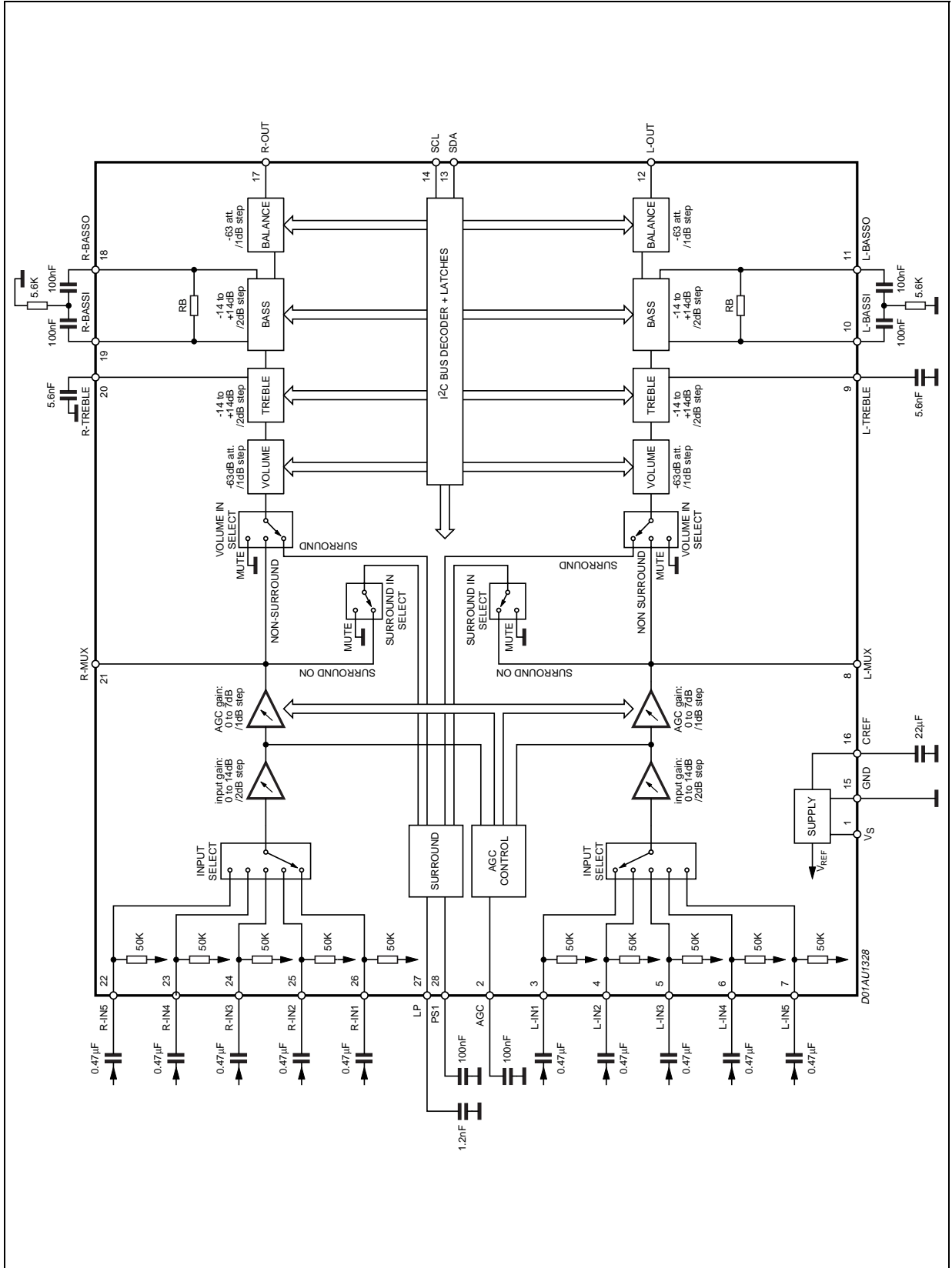

ABSOLUTE MAXIMUM RATINGS

Symbol	Parameter	Value	Unit
V _s	Operating Supply Voltage	10.5	V
T _{amb}	Operating Ambient Temperature	-10 to 85	°C
T _{stg}	Storage Temperature Range	-55 to 150	°C

THERMAL DATA

Symbol	Parameter	Value	Unit
R _{th j-pin}	Thermal Resistance Junction-pins	85	°C/W

QUICK REFERENCE DATA

Symbol	Parameter	Min.	Typ.	Max.	Unit
V _S	Supply Voltage	5	9	10	V
V _{CL}	Max. input signal handling	2			V _{rms}
THD	Total Harmonic Distortion V=1V _{rms} f=1kHz		0.01	0.1	%
S/N	Signal to Noise Ratio V _{OUT} =1V _{rms} (mode=OFF)		100		dB
S _C	Channel Separation f=1kHz		90		dB
	Input Gain (2dB step)	0		14	dB
	AGC Gain (1dB step)	0		7	dB
	Volume Control (1dB step)	-63		0	dB
	Treble Control (2dB step)	-14		+14	dB
	Bass Control (2dB step)	-14		+14	dB
	Balance Control (1dB step)	-63		0	dB
	Mute Attenuation		90		dB

TDA7443D

ELECTRICAL CHARACTERISTICS

(Refer to the test circuit $T_{amb}=25^{\circ}\text{C}$, $V_s=9\text{V}$, $f=1\text{kHz}$, all controls flat, unless otherwise specified)

Symbol	Parameter	Conditions	Min.	Typ.	Max.	Unit
--------	-----------	------------	------	------	------	------

SUPPLY

V_S	Supply Voltage		5	9	10	V
I_S	Supply Current			tbid		mA
SVR	Ripple Rejection		60	80		dB

INPUT STAGE

R_{IN}	Input Resistance		35	50	65	$k\Omega$
V_{CL}	Clipping Level	THD = 0.3%	2	2.5		V_{rms}
S_{IN}	Input Separation		80	100		dB
$G_{in\ min}$	Minimum Input Gain		-1	0	1	dB
$G_{in\ max}$	Maximum Input Gain		13	14	15	dB
$G_{in\ step}$	Step Resolution		1.5	2	2.5	dB

AGC

G_{AGCmin}	Minimum AGC Gain		-1	0	1	dB
G_{AGCmax}	Maximum AGC Gain		6	7	8	dB
$G_{AGCstep}$	Step Resolution		0.5	1	1.5	dB

SURROUND

R_{IN}	Input Resistance		35	50	65	$k\Omega$
R_{PS0}	Phase Shifter:D1=0,D0=0		8.3	11.8	15.2	$k\Omega$
R_{PS1}	Phase Shifter:D1=0,D0=1		10	14.1	18.3	$k\Omega$
R_{PS2}	Phase Shifter:D1=1,D0=0		12.6	17.9	23.3	$k\Omega$
R_{PS3}	Phase Shifter:D1=1,D0=1		26.4	37.3	48.85	$k\Omega$
CRANGE	Effect Control Range		-21		-6	dB
S_{step}	Effect Control Step Resolution		0.5	1	1.5	dB

VOLUME CONTROL

$AVOLmin$	Minimum Attenuation		-1	0	1	dB
$AVOLmax$	Maximum Attenuation		61	63	65	dB
$AVOLstep$	Step Resolution		0.5	1	1.5	dB
E_A	Attenuation set error	$A_V = 0$ to -24 dB	-1	0	1	dB
		$A_V = -24$ to -63 dB	-2	0	2	dB
V_{DC}	DC Steps	Adjacent att. steps	-3	0	3	mV

BASS CONTROL

G_B	Control Range	Max. Boost/Cut	± 12	± 14	± 16	dB
-------	---------------	----------------	----------	----------	----------	----

ELECTRICAL CHARACTERISTICS (continued)(Refer to the test circuit $T_{amb}=25^{\circ}\text{C}$, $V_s=9\text{V}$, $f=1\text{kHz}$, all controls flat, unless otherwise specified)

Symbol	Parameter	Conditions	Min.	Typ.	Max.	Unit
B_{step}	Step Resolution		1	2	3	dB
R_B	Internal Feedback Resistance		33	44	55	$k\Omega$

TREBLE CONTROL

G_T	Control Range	Max. Boost/Cut	± 13	± 14	± 15	dB
T_{step}	Step Resolution		1	2	3	dB
R_T	Internal Feedback Resistance			25		$k\Omega$

BALANCE CONTROL

A_{BALmin}	Minimum Attenuation		-1	0	1	dB
A_{BALmax}	Maximum Attenuation		61	63	65	dB
$A_{BALstep}$	Step Resolution			1		dB
E_A	Attenuation set error	$A_V = 0$ to -24 dB	-1	0	1	dB
		$A_V = -24$ to -63 dB	-2	0	2	dB
V_{DC}	DC Steps	Adjacent att. steps	-3	0	3	mV

AUDIO OUTPUTS

V_{OCL}	Clipping Level	THD = 0.3%	2	2.5		Vrms
R_L	Output Load Resistance		2			$k\Omega$
V_{OUT}	DC Voltage Level			4.5		V
$N_{O(OFF)}$	Output Noise (OFF)	BW=20Hz to 20kHz; All gains 0dB; Output muted flat		5 10	15	μV μV
$N_{O(MUS)}$	Output Noise (Music)	BW=20Hz to 20kHz; Mode=Music		30		μV
$N_{O(PS)}$	Output Noise(Pseudo Stereo)	BW=20Hz to 20kHz; Mode=Pseudo Stereo		30		μV
A_{MUTE}	Output Mute Condition			90		dB
S/N	Signal to Noise Ratio	All gains 0dB; $V_O = 1\text{Vrms}$		100		dB
S_C	Channel Separation Left/Right			90		dB
d	Distortion	$A_V = 0$; $V_I = 1\text{Vrms}$		0.01	0.1	%

BUS INPUT

V_{IL}	Input Low Voltage				1	V
V_{IH}	Input High Voltage		2.5			V
I_{IN}	Input Current	$V_{IN} = 0.4\text{V}$	-5		5	μA
V_O	Output Voltage (ACK)	$I_O = 1.6\text{mA}$		0.4	0.8	V

I²C BUS INTERFACE

Data transmission from microprocessor to the TDA7443D and vice versa takes place through the 2 wires I²C BUS interface, consisting of the two lines SDA and SCL (pull-up resistors to positive supply voltage must be connected).

Data Validity

As shown in fig. 1, the data on the SDA line must be stable during the high period of the clock. The HIGH and LOW state of the data line can only change when the clock signal on the SCL line is LOW.

Start and Stop Conditions

As shown in fig. 2 a start condition is a HIGH to LOW transition of the SDA line while SCL is HIGH. The stop condition is a LOW to HIGH transition of the SDA line while SCL is HIGH.

Byte Format

Every byte transferred on the SDA line must contain 8 bits. Each byte must be followed by an acknowledge bit. The MSB is transferred first.

Acknowledge

The master (μ P) puts a resistive HIGH level on the SDA line during the acknowledge clock pulse (see fig. 3). The peripheral (audio processor) that acknowledges has to pull-down (LOW) the SDA line during this clock pulse.

The audio processor which has been addressed has to generate an acknowledge after the reception of each byte, otherwise the SDA line remains at the HIGH level during the ninth clock pulse time. In this case the master transmitter can generate the STOP information in order to abort the transfer.

Transmission without Acknowledge

Avoiding to detect the acknowledge of the audio processor, the μ P can use a simpler transmission: simply it waits one clock without checking the slave acknowledging, and sends the new data.

This approach of course is less protected from misworking.

Figure 1. Data Validity on the I²C BUS

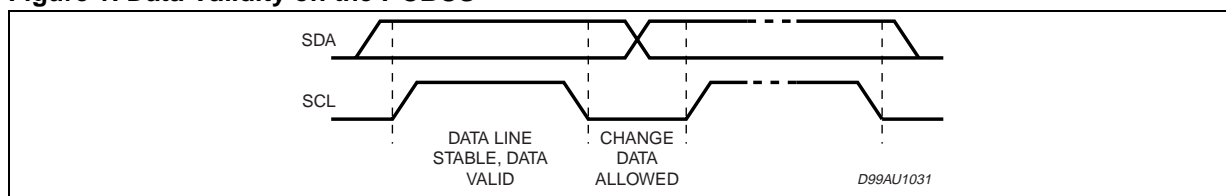

Figure 2. Timing Diagram of I²C BUS

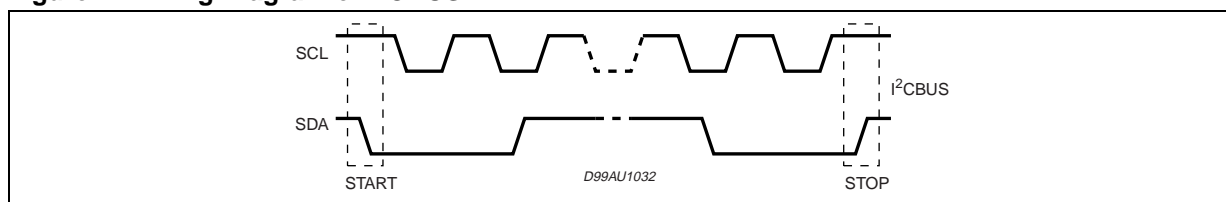
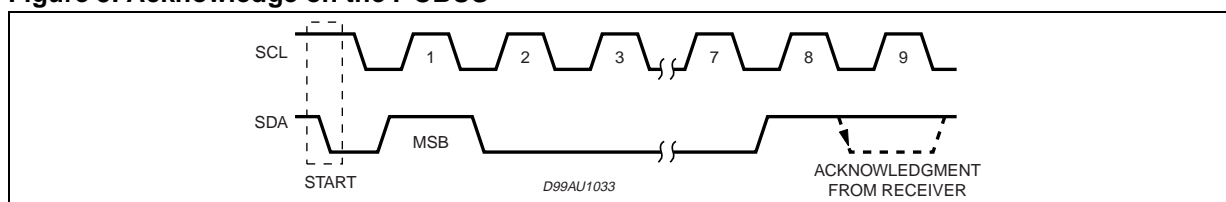

Figure 3. Acknowledge on the I²C BUS



SOFTWARE SPECIFICATION

Interface Protocol

The interface protocol comprises:

- A start condition (S)
- A chip address byte, containing the TDA7440D address
- A subaddress bytes
- A sequence of data (N byte + acknowledge)
- A stop condition (P)

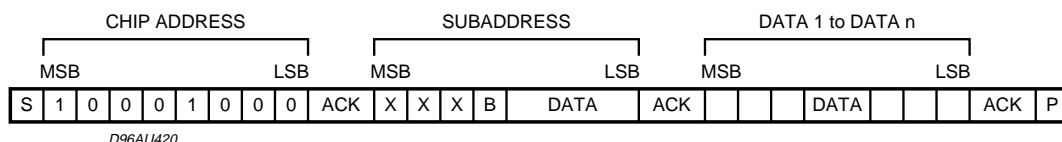

ACK = Acknowledge; S = Start; P = Stop; A = Address; B = Auto Increment

EXAMPLES

No Incremental Bus

The TDA7443D receives a start condition, the correct chip address, a subaddress with the B = 0 (no incremental bus), N-data (all these data concern the subaddress selected), a stop condition.

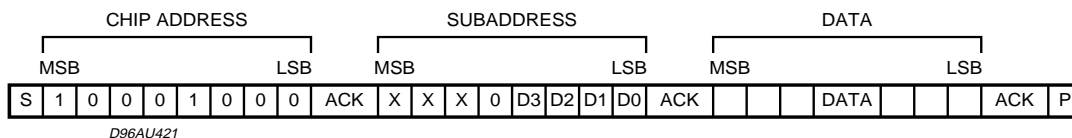

Incremental Bus

The TDA7443D receives a start conditions, the correct chip address, a subaddress with the B = 1 (incremental bus): now it is in a loop condition with an autoincrease of the subaddress whereas SUBADDRESS from "XXX1000" to "XXX1111" of DATA are ignored. The DATA 1 concern the subaddress sent, and the DATA 2 concern the subaddress sent plus one in the loop etc, and at the end it receives the stop condition.

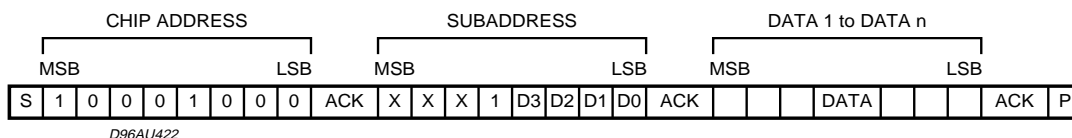

TDA7443D

POWER ON RESET CONDITION

MSB							LSB
D7	D6	D5	D4	D3	D2	D1	D0
1	1	1	1	1	1	1	0

DATA BYTES

Address=(HEX) 10001000

FUNCTION SELECTION: First byte (subaddress)

MSB							LSB	SUBADDRESS
D7	D6	D5	D4	D3	D2	D1	D0	
X	X	X	B	0	0	0	0	INPUT
X	X	X	B	0	0	0	1	AGC
X	X	X	B	0	0	1	0	SURROUND
X	X	X	B	0	0	1	1	VOLUME
X	X	X	B	0	1	0	0	tone
X	X	X	B	0	1	0	1	BALANCE "L"
X	X	X	B	0	1	1	0	BALANCE "R"

B=1: INCREMENTAL BUS; ACTIVE

B=0: NO INCREMENTAL BUS

X= INDIFFERENT 0/1

INPUT

MSB							LSB	SUBADDRESS
D7	D6	D5	D4	D3	D2	D1	D0	
								INPUT SELECT
					0	0	0	IN1
					0	0	1	IN2
					0	1	0	IN3
					0	1	1	IN4
					1	X	X	IN5
								MUTE
				0				Output Mute OFF
				1				Output Mute ON
								SURROUND IN SELECT
			0					Surround ONI
			1					Mute
								INPUT GAIN
0	0	0						0dB
0	0	1						2dB
0	1	0						4dB
0	1	1						6dB
1	0	0						8dB
1	0	1						10dB
1	1	0						12dB
1	1	1						14dB

AGC

MSB								LSB	SUBADDRESS
D7	D6	D5	D4	D3	D2	D1	D0		
									AGC MODE
							0	OFF	
							1	ON	
									DETECTOR
						0		OFF	
						1		ON	
									RELEASE CURRENT
					0			OFF	
					1			ON	
									ATTACK TIME
			0	0				ATTACK1	
			0	1				ATTACK2	
			1	0				ATTACK3	
			1	1				ATTACK4	
									TARGET LEVEL
	0	0						TARGET1	
	0	1						TARGET2	
	1	0						TARGET3	
	1	1						TARGET4	
									ZEROCROSS
0								OFF	
1								ON	

SURROUND

MSB							LSB		SUBADDRESS
D7	D6	D5	D4	D3	D2	D1	D0		
								SURROUND MODE	
						0		PSEUDO STEREO	
						1		MUSIC	
								EFFECT CONTROL	
		0	0	0	0			-6 dB	
		0	0	0	1			-7 dB	
		0	0	1	0			-8 dB	
		0	0	1	1			-9 dB	
		0	1	0	0			-10 dB	
		0	1	0	1			-11 dB	
		0	1	1	0			-12 dB	
		0	1	1	1			-13 dB	
		1	0	0	0			-14 dB	
		1	0	0	1			-15 dB	
		1	0	1	0			-16 dB	
		1	0	1	1			-17 dB	
		1	1	0	0			-18 dB	
		1	1	0	1			-19 dB	
		1	1	1	0			-20 dB	
		1	1	1	1			-21 dB	
								PHASE SHIFT RESISTOR	
0	0							12 kohm	
0	1							14 kohm	
1	0							18 kohm	
1	1							37 kohm	

VOLUME

MSB							LSB		SUBADDRESS
D7	D6	D5	D4	D3	D2	D1	D0		
								VOLUME IN SELECT	
						0	0	Surround	
						0	1	Non Surround	
						1	X	Mute	
								1dB STEPS	
			0	0	0			0dB	
			0	0	1			-1dB	
			0	1	0			-2dB	
			0	1	1			-3dB	
			1	0	0			-4dB	
			1	0	1			-5dB	
			1	1	0			-6dB	
			1	1	1			-7dB	
								8dB STEPS	
0	0	0						0dB	
0	0	1						-8dB	
0	1	0						-16dB	
0	1	1						-24dB	
1	0	0						-32dB	
1	0	1						-40dB	
1	1	0						-48dB	
1	1	1						-56dB	

VOLUME=0 to -63dB

TREBLE & BASS

MSB								LSB	SUBADDRESS
D7	D6	D5	D4	D3	D2	D1	D0		
								TREBLE	
				0	0	0	0	-14 dB	
				0	0	0	1	-12 dB	
				0	0	1	0	-10 dB	
				0	0	1	1	-8 dB	
				0	1	0	0	-6 dB	
				0	1	0	1	-4 dB	
				0	1	1	0	-2 dB	
				0	1	1	1	0 dB	
				1	0	0	0	14 dB	
				1	0	0	1	12 dB	
				1	0	1	0	10 dB	
				1	0	1	1	8 dB	
				1	1	0	0	6 dB	
				1	1	0	1	4 dB	
				1	1	1	0	2 dB	
				1	1	1	1	0 dB	
								BASS	
0	0	0	0					-14 dB	
0	0	0	1					-12 dB	
0	0	1	0					-10 dB	
0	0	1	1					-8 dB	
0	1	0	0					-6 dB	
0	1	0	1					-4 dB	
0	1	1	0					-2 dB	
0	1	1	1					0 dB	
1	0	0	0					14 dB	
1	0	0	1					12 dB	
1	0	1	0					10 dB	
1	0	1	1					8 dB	
1	1	0	0					6 dB	
1	1	0	1					4 dB	
1	1	1	0					2 dB	
1	1	1	1					0 dB	

BALANCE

MSB							LSB	SUBADDRESS
D7	D6	D5	D4	D3	D2	D1	D0	
								1dB STEPS
			0	0	0			0dB
			0	0	1			-1dB
			0	1	0			-2dB
			0	1	1			-3dB
			1	0	0			-4dB
			1	0	1			-5dB
			1	1	0			-6dB
			1	1	1			-7dB
								8dB STEPS
0	0	0						0dB
0	0	1						-8dB
0	1	0						-16dB
0	1	1						-24dB
1	0	0						-32dB
1	0	1						-40dB
1	1	0						-48dB
1	1	1						-56dB

VOLUME=0 to -63dB

DIM.	mm			inch		
	MIN.	TYP.	MAX.	MIN.	TYP.	MAX.
A			2.65			0.104
a1	0.1		0.3	0.004		0.012
b	0.35		0.49	0.014		0.019
b1	0.23		0.32	0.009		0.013
C		0.5			0.020	
c1	45° (typ.)					
D	17.7		18.1	0.697		0.713
E	10		10.65	0.394		0.419
e		1.27			0.050	
e3		16.51			0.65	
F	7.4		7.6	0.291		0.299
L	0.4		1.27	0.016		0.050
S	8° (max.)					

OUTLINE AND MECHANICAL DATA

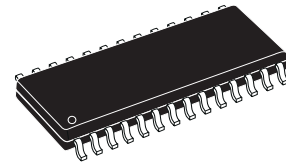

SO28

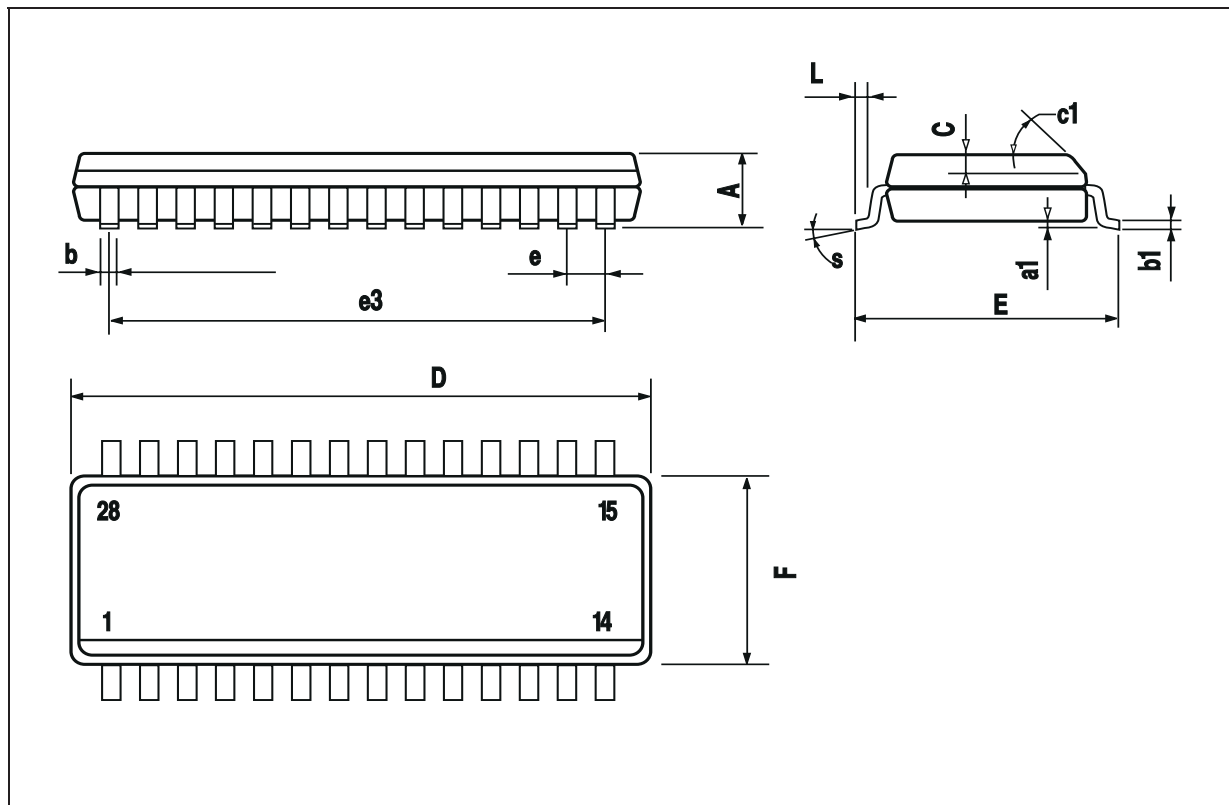

Information furnished is believed to be accurate and reliable. However, STMicroelectronics assumes no responsibility for the consequences of use of such information nor for any infringement of patents or other rights of third parties which may result from its use. No license is granted by implication or otherwise under any patent or patent rights of STMicroelectronics. Specifications mentioned in this publication are subject to change without notice. This publication supersedes and replaces all information previously supplied. STMicroelectronics products are not authorized for use as critical components in life support devices or systems without express written approval of STMicroelectronics.

The ST logo is a registered trademark of STMicroelectronics
© 2002 STMicroelectronics - All Rights Reserved

STMicroelectronics GROUP OF COMPANIES

Australia - Brazil - Canada - China - Finland - France - Germany - Hong Kong - India - Israel - Italy - Japan - Malaysia - Malta - Morocco -
Singapore - Spain - Sweden - Switzerland - United Kingdom - United States.

<http://www.st.com>