

Features

- Multistandard video IF
- Interference suppression circuitry
- Mean/peak value control
- Area of application: multistandard TV / VCR, mono, stereo cable converter, mono, stereo

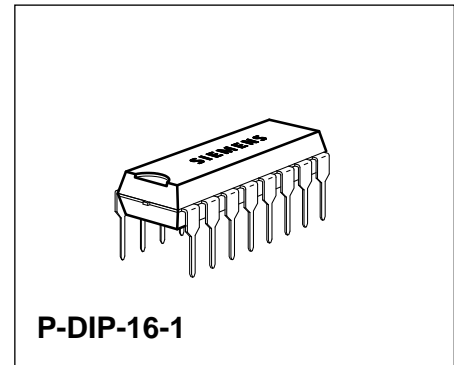

Type	Ordering Code	Package
TDA 5930-5	Q67000-A5135	P-DIP-16-1

Circuit Description

Video IF for all European standards. The analog setting function (delayed tuner AGC threshold) is controlled via a potentiometer.

The IC is suitable for use in Euro- or multi-standard TV sets for mono and stereo application.

The component includes a four-stage, capacitively coupled, symmetrically designed and controlled amplifier, a limiter with selection, and a mixer for quasi-synchronous demodulation of positive and negative modulated IF signals. In addition a video output amplifier and noise suppression circuitry are included. This output is used for generating the AGC voltage. The AGC for both modulation types has been realized as integral AGC with noise-free peak and mean value detector (only for positive modulation). A delayed tuner AGC with positive AGC direction (increase in tuner AGC voltage → increased gain) is derived from the AGC voltage via a threshold amplifier set by means of an external potentiometer.

A positive video output with 3 V_{pp} and a negative video output with 2 V_{pp} are available.

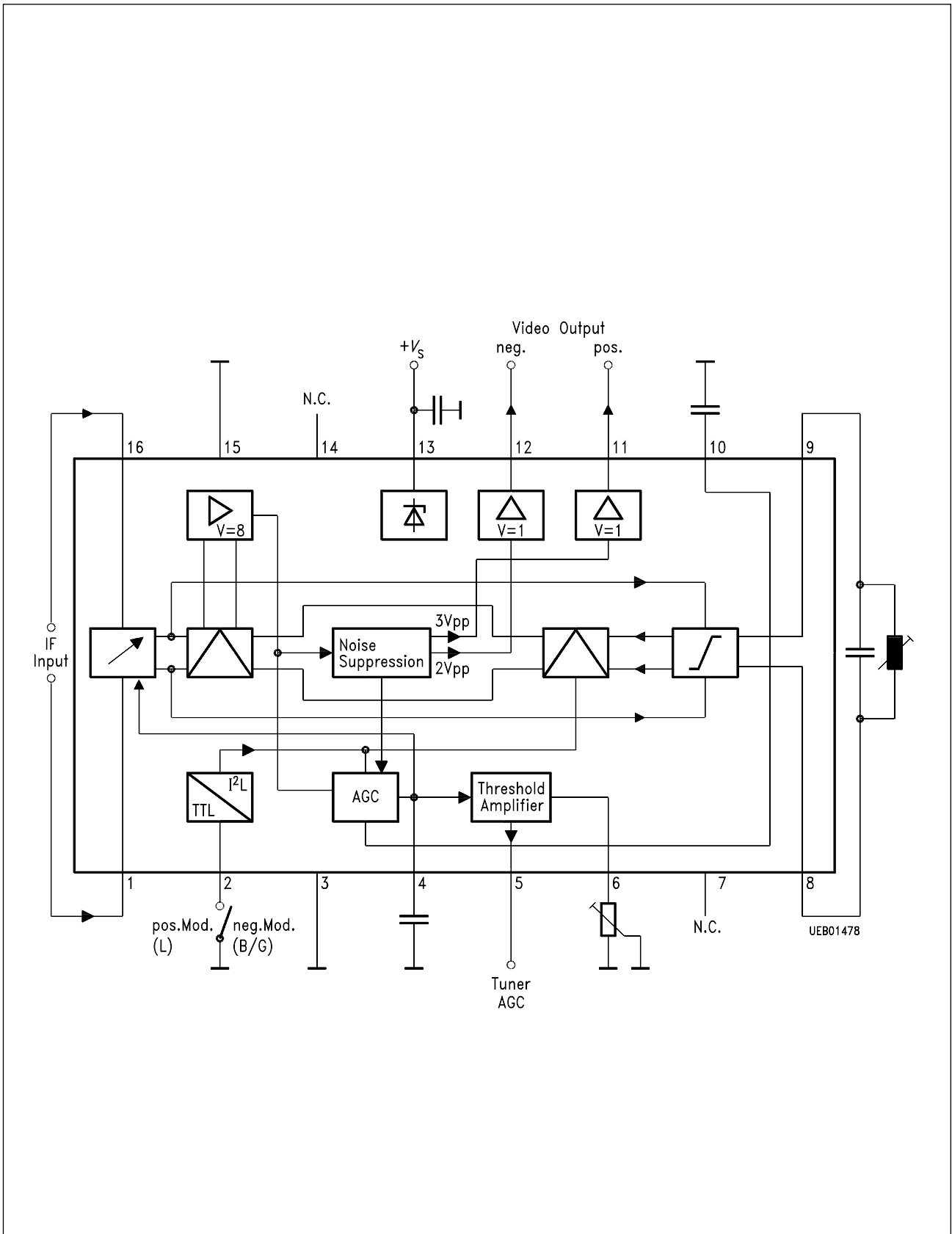

Block Diagram

Pin Functions

Pin No.	Function
1	Video IF input
2	Standard switch over B/G-L
3	Ground
4	AGC time constant
5	Tuner AGC output
6	Tuner AGC threshold
7	N.C.
8	Demodulator tank circuit
9	Demodulator tank circuit
10	Low pass (mean value generation)
11	Positive video output
12	Negative video output
13	Supply voltage
14	N.C.
15	Ground
16	Video IF input

Absolute Maximum Ratings

$T_A = 25\text{ °C}$

Parameter	Symbol	Limit Values		Unit
		min.	max.	
Supply voltage	V_{13}	0	13.5	V
Pos. video output	I_{11}	- 3	5	mA
Pos. video output	V_{11}	0	10	V
Demodulator tank circuit	V_8/V_9	0	+ V_{13}	V
Neg. video output	I_{12}	- 3	5	mA
Neg. video output	V_{12}	0	+ V_{13}	V
Tuner AGC threshold	V_6	0	6	V
Tuner AGC output	V_5	0	+ V_{13}	V
IF input	V_1/V_{16}	0	6	V
IF control	V_4	0	8.5	V
Standard switch-over	V_2	0	6	V
Auxiliary control	V_{10}	0	6	V
Junction temperature	T_j		150	°C
Storage temperature	T_{stg}	- 40	125	°C
Thermal resistance (system-air)	$R_{th SA}$		70	K/W

Operating Range

Supply voltage	V_{13}	10.5	13.5	V
Supply voltage, delayed tuner AGC	V_5	1	13.5	V
Ambient temperature during operation	T_A	0	70	°C
Input frequency range - 3 dB	f_{IF}	10	100	MHz
Input frequency range - 0.3 dB	f_{IF}	30	75	MHz

All voltage values are referenced to ground pin 3, 15, if not stated otherwise. The currents are identified according to the source/sink principle.

If the IC is considered a sink (the current flows from the respective pin to ground), it is identified by a negative algebraic sign.

However, if the IC is the source (the current flows from V_8 via the respective pin), it is identified by a positive algebraic sign.

Characteristics

$V_S = V_{13/15} = 12 \text{ V} \pm 10 \%$; $T_A = 25 \text{ }^\circ\text{C}$

Parameter	Symbol	Limit Values			Unit	Test Condition
		min.	typ.	max.		

DC Characteristics

Tot. current consumption		37	53	69	mA	$V_{1/16} = 10 \text{ mVrms}$
--------------------------	--	----	----	----	----	-------------------------------

AGC Voltage (figure 1)

Min. AGC	V_4	0	0.1	0.5	V	$V_{1/16} = 45 \text{ } \mu\text{Vrms}$
Max. AGC	V_4	2.6	2.85	4.5	V	$V_{1/16} = 175 \text{ mVrms}$

AGC-Time Constant (figure 6) with Neg. Modulation

Charge current ($I_{\max} \cdot 2$)	I_4	0.7	0.9	1.1	mA	$V_4 = 2 \text{ V}$; $V_{11} < 5.2 \text{ V}$
Discharge current	$-I_4$	12	17	23	μA	$V_4 = 2 \text{ V}$; $V_{11} > 6.3 \text{ V}$
Charge/discharge ratio	V_4	75	105	150		

AGC-Time Constant (figure 7) with Pos. Modulation

Charge current	I_4	5.5	7	8.0	mA	$V_4 = 2 \text{ V}$; $V_{11} \geq 9 \text{ V}$
Discharge current	$-I_4$	0.1	0.2	0.3	μA	$V_4 = 2 \text{ V}$; $4.5 \text{ V} < V_{11} < 8.2 \text{ V}$
Discharge current	$-I_4$	270	330	420	μA	$V_4 = 2 \text{ V}$; $V_{11} < 6 \text{ V}$
Charge/discharge ratio	V_4	20000	35000	75000		

Mean Value Generation with Pos. Modulation

White level	V_{10}	3.9	4.3	4.7	V	$V_{1/16} = 10 \text{ mVrms}$
Zero carrier level	V_{10}	3.3	3.7	4.1	V	$V_{1/16} = 0 \text{ V}$; $V_4 = 3 \text{ V}$
Tuner AGC threshold (figure 2)	V_6	3.9	4.3	4.7	V	$R_{6/15} = \infty$
$I_5 = I_{\max} \cdot 2$	I_6	550	750	950	μA	$V_6 = 0 \text{ V}$
	V_4	2.8	3.1	3.4	V	$R_{6/15} = 10 \text{ k}\Omega$
	V_4	0.35	0.4	0.45	V	
Tuner AGC current (figure 3, 4)	$-I_5$	3.0	4.0	5.0	mA	$V_5 = 0.5 V_{13}$ $V_{1/16} = 100 \text{ mVrms}$ $V_6 = 0.75 \text{ V}$
	$-I_5$	0	–	10	μA	$V_5 = 0.5 V_{13}$ $V_{1/16} = 10 \text{ mVrms}$ $V_6 = 4.0 \text{ V}$

The characteristics data apply to the supply voltage range V_S stated or in case of alignment to the alignment instructions (see page 21). All static voltages are referenced to ground if not stated otherwise.

The input levels are given as rms values referenced to synchronous peak $f_{PC} = 38.9 \text{ MHz}$.

Characteristics (cont'd)

$T_A = 25\text{ °C}$

Parameter	Symbol	Limit Values			Unit	Test Condition
		min.	typ.	max.		

Mean Value Generation with Pos. Modulation (cont'd)

IF input	V_1, V_{16}	5.7	6.0	6.3	V	
Demodulator tank circuit	V_8, V_9	V_{13} - 3.5	V_{13} - 3.8	V_{13} - 4.1	V	

Pos. Video Output (figure 8)

Output current	$-I_{11}$	1.7	2.2	2.7	mA	$V_{11} = 9\text{ V}$ to ground via $R = 1\text{ k}\Omega$
	I_{11}	4			mA	

Pos. Modulation (L norm)

White level	V_{11}	5.9	6.6	7.3	V	$V_{1/16} = 10\text{ mVrms}$
Zero carrier (sync.)	V_{11}	3.3	3.6	4.0	V	$V_{1/16} = 0\text{ V}; V_4 = 3\text{ V}$

Neg. Modulation (BG norm)

Sync. pulse level	V_{11}	3.3	3.6	4.0	V	$V_{1/16} = 10\text{ mVrms}$
Zero carrier	V_{11}	6.2	6.9	7.6	V	$V_{1/16} = 0\text{ V}; V_4 = 3\text{ V}$

Neg. Video Output (figure 9)

Output current	$-I_{12}$	1.7	2.2	2.7	mA	$R_L = \infty$
	I_{12}	4			mA	$V_{12} = V_{13}$

Pos. Modulation (L norm)

White level	V_{12}	V_{13} - 5.7	V_{13} - 4.95	V_{13} - 4.2	V	$V_{1/16} = 10\text{ mVrms}$
Zero carrier (sync.)	V_{12}	V_{13} - 3.3	V_{13} - 2.8	V_{13} - 2.4	V	$V_{1/16} = 0\text{ V}; V_4 = 3\text{ V}$

Neg. Modulation (BG norm)

Sync. pulse level	V_{12}	V_{13} - 3.3	V_{13} - 2.8	V_{13} - 2.4	V	$V_{1/16} = 10\text{ mVrms}$
Zero carrier	V_{12}	V_{13} - 5.9	V_{13} - 5.2	V_{13} - 4.4	V	$V_{1/16} = 0\text{ V}; V_4 = 3\text{ V}$

Video output voltages (peak-to-peak) $PC = 10\text{ mVrms}$
with neg. modulation = 10%; with pos. modulation and residual carrier < 6%.

Characteristics (cont'd)

$T_A = 25\text{ °C}$

Parameter	Symbol	Limit Values			Unit	Test Condition
		min.	typ.	max.		

Switching Voltage (figure 12)

L = L/E standard	V_2	0		1.8	V	
H = B/G stand. or open	V_2	2.6		6	V	

Dynamic Characteristics

Min. IF-Input Voltage (figure 1)

(min. gain) PC rms $V_{1/16}$			45	60	μV	$V_{11pp} - 1\text{ dB}$
------------------------------------	--	--	----	----	---------------	--------------------------

Max. IF-Input Voltage (figure 1)

(max. gain) PC rms		105	140		mV	$V_{1/16} V_{11pp} + 1\text{ dB}$
IF-control range (figure 1)	ΔV	65	70		dB	
Pos. video output (figure 8)	V_{11}	2.7	3.0	3.3	V_{pp}	$R_L \geq 1.5\text{ k}\Omega$
Change ΔV_{11} by standard switch-over	ΔV_{11}		1	5	%	0 V < V_2 < 2 V = B/G Operat. 2.6 V < V_2 < 6 V = L Operat.
Changes via operating voltage	$\Delta V_{11}/$ ΔV_{13}		1.5	3	%	10.8 V < V_{13} < 13.2 V
Neg. video output (figure 9)	V_{12}	1.95	2.15	2.35	V_{pp}	$R_L = \infty$
Video output voltage change (figure 8) by means of a control range of 55 dB						
	ΔV_{11}		0.2	0.5	dB	

Design Notes (no 100 % final test)

Input resistance (symmetrical)	$R_{1/16}$	1.5	2	2.5	$\text{k}\Omega$	
Input capacitance (symmetrical)	$C_{1/16}$		2	5	pF	
Low pass cut-off frequency (figure 5)	$f_{-3\text{ dB}(10)}$	70	100	130	Hz	$C_{10/15} =$ 100 nF \pm 10 %

Characteristics (cont'd)

$T_A = 25\text{ °C}$

Parameter	Symbol	Limit Values			Unit	Test Condition
		min.	typ.	max.		

Design Notes (no 100 % final test) (cont'd)

Intercarrier noise voltage ratio (weighted according CCIR 468) (**figure 13**) with parallel tank circuit; 38.9 MHz, SAW 361 D, $f_{SC} = 5.5\text{ MHz}$ (– 13 dB), demodulator: TBA 120 U

	S/N		48		dB	$V_{1/16} = 10\text{ mVpp}$ FuBK mod.
	S/N		17		dB	$V_{1/16} = 10\text{ mVpp}$ 2.753 MHz mod.
FuBK-test chart	$-\Delta S/N$		2		dB	with detuning $\Delta f = -400\text{ kHz}$
FuBK-test chart	$-\Delta S/N$		11		dB	with detuning $\Delta f = +400\text{ kHz}$
Dyn. output resistance pos. video output	R_{11}	80	115	150	Ω	
neg. video output	R_{12}	100	150	200	Ω	
Noise figure (figure 14) $V_{1/16} = -45\text{ dBm} = +62\text{ dB}\mu\text{V}$ $R_{GEN} = 800\ \Omega$	F		5	7	dB	
Video noise voltage ratio (figure 15) with $PC = 10\text{ mVrms}$						
0 dB = 700 mVpp BA unweighted	S/N	50	55		dB	
weighted according to CCIR Rec. 567-1	S/N	55	60		dB	
Video frequency response (figure 16)						
– 3 dB	$B_{-3\text{ dB}}$	8	10	13	MHz	
– 12 dB	$B_{-12\text{ dB}}$	15	17	20	MHz	
Residual carrier voltage at video output $PC = 10\text{ mVrms}$ Fundamental wave						
$f = 38.9\text{ MHz}$	V_{11}		3.0	6.0	mV	
1. harmonic wave $f = 77.8\text{ MHz}$	V_{11}		0.3	0.6	mV	

Characteristics (cont'd)

$T_A = 25\text{ °C}$

Parameter	Symbol	Limit Values			Unit	Test Condition
		min.	typ.	max.		

Design Notes (no 100 % final test) (cont'd)

Differential gain CCIR Rec. 567-1 (figure 17) with $PC = 10\text{ mV}$ peak-to-peak according to stairsignal test Changes via AGC Changes via detuning $f_{BT} = 38.9\text{ MHz}$; $\Delta f = \pm 400\text{ kHz}$	DG		4	6	%	
	$\Delta DG/\Delta v$			1	%	
	$\Delta DG/\Delta f$			1	%	
Differential phase CCIR Rec. 567-1 (figure 17) with $PC = 10\text{ mVrms}$ peak-to-peak according to stairsignal test Changes via AGC Changes via detuning $f_{BT} = 38.9\text{ MHz}$; $\Delta f = \pm 400\text{ kHz}$	DP		1.5	2.5	deg	
	$\Delta DP/\Delta v$			1	deg	
	$\Delta DP/\Delta f$			2	deg	
Intermodulation ratio (figure 18) with $f_{IM} = 1.07\text{ MHz} = f_{SC} - f_{CC}$ with $PC = 10\text{ mVrms}$ with sound porch – 3 dB with sound porch – 20 dB with sound porch – 17 dB	a_{IM}	32	38		dB	OFWG 3950
	a_{IM}	54	60		dB	OFW 3610
	a_{IM}	51	57		dB	OFWG 1956
Demodulator tank circuit voltage $f_{PC} = 38.9\text{ MHz}$; $C = 47\text{ pF}$ $L = 350\text{ nH}$ $100 \leq Q_0 \leq 120$; $Q_B \approx 60$; $B \approx 0.8 \dots 1.0\text{ MHz}$	$V_{8/9}$	300	450	600	mVpp	
Synchronous pulse	$\Delta V_{Sync}/V_{11}$			5	%	

Characteristics (cont'd)

$T_A = 25\text{ °C}$

Parameter	Symbol	Limit Values			Unit	Test Condition
		min.	typ.	max.		

Design Notes (no 100 % final test) (cont'd)

Temperature drift of the tuner AGC threshold referred to the input voltage				2	dB	$I_5 = I_{5max}/2$ caused by the self-heating of the ICs 10 s to 15 min.
Ratio pulse bar tilt to sync. amplitude				4	%	
Reaction time of white level peak setting, L standard				10	μs	low-pass filter in regulation slope ca. 300 kHz

Alignment Instructions

At a video carrier input level of $V_{1/16} = 4\text{ mVrms}$, $f_{PC} = 38.9\text{ MHz}$, and a superimposed AGC voltage of $V_4 = 1.5\text{ V}$, the demodulator tank circuit is preliminarily aligned until a max. video signal V_{11pp} is obtained at the positive video output. Any suitable video test signal can be used for modulation. The AGC voltage V_4 is reduced until the signal is approx. 3 Vpp and the max. video signal is obtained when fine-aligning the demodulator tank circuit. The alignment is not critical due to relatively large bandwidth of the demodulator tank circuit. Fine-tuning to intercarrier S/N , differential phase or 2T-pulse characteristics is possible.

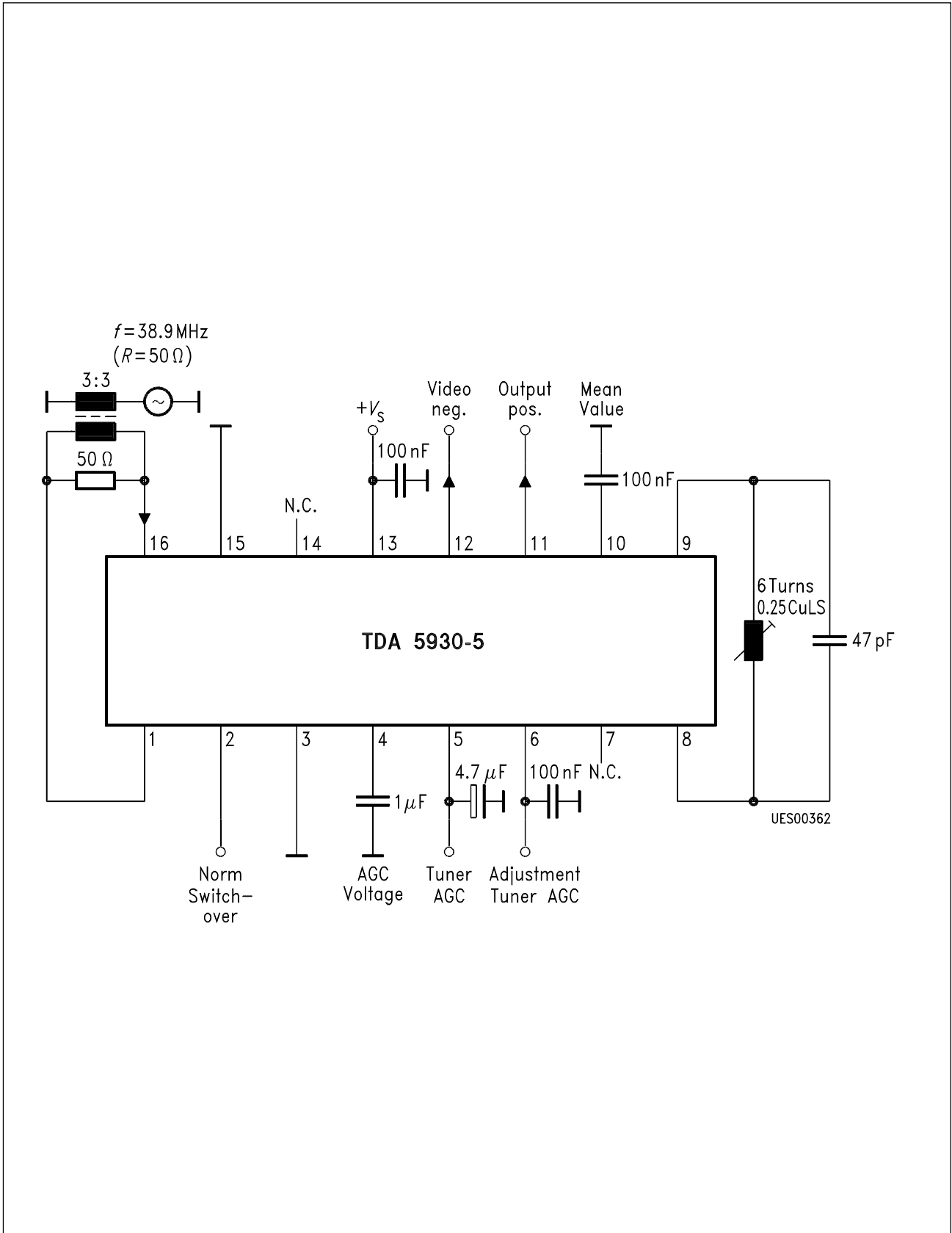

Test Circuit

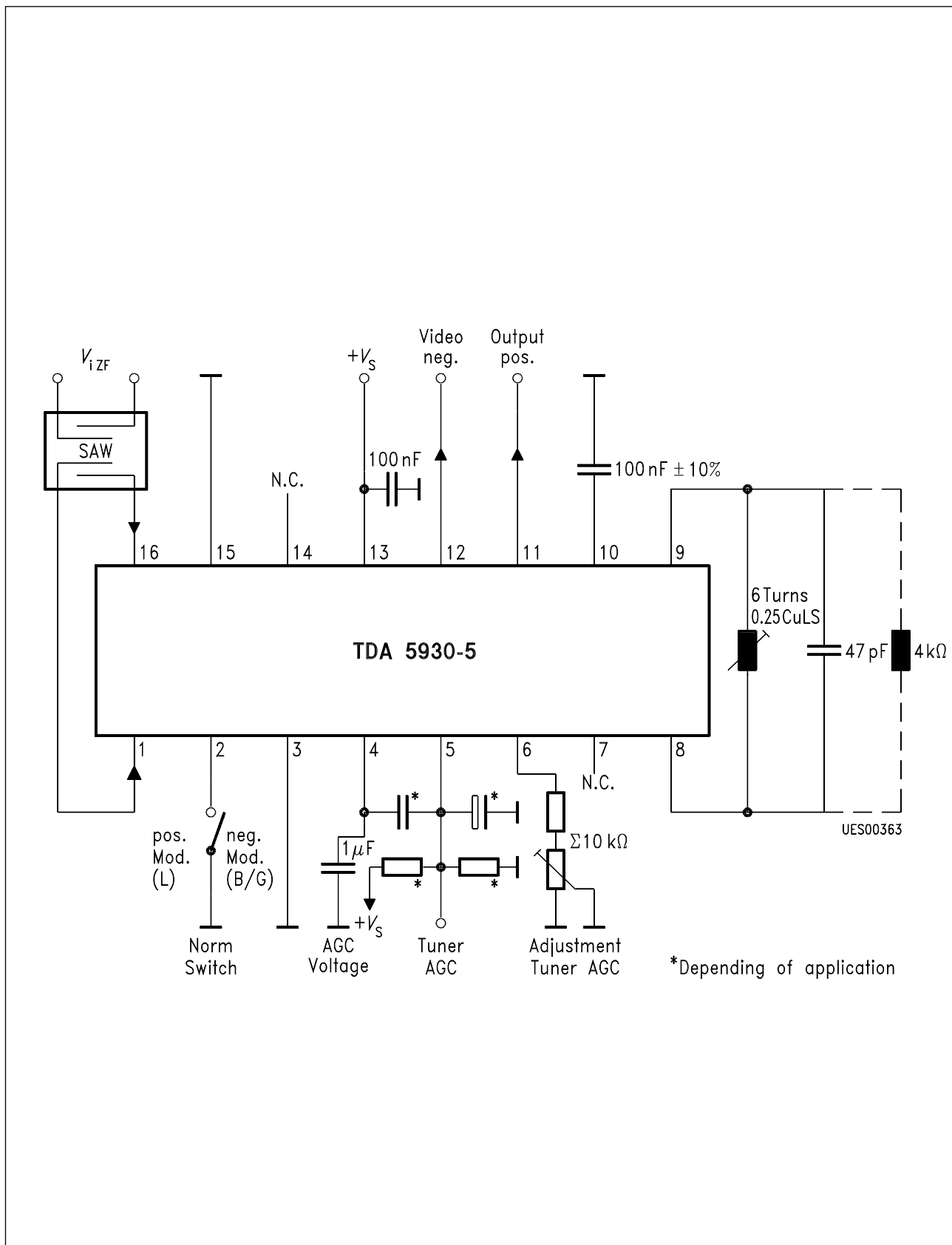

Application Circuit

AGC Voltage

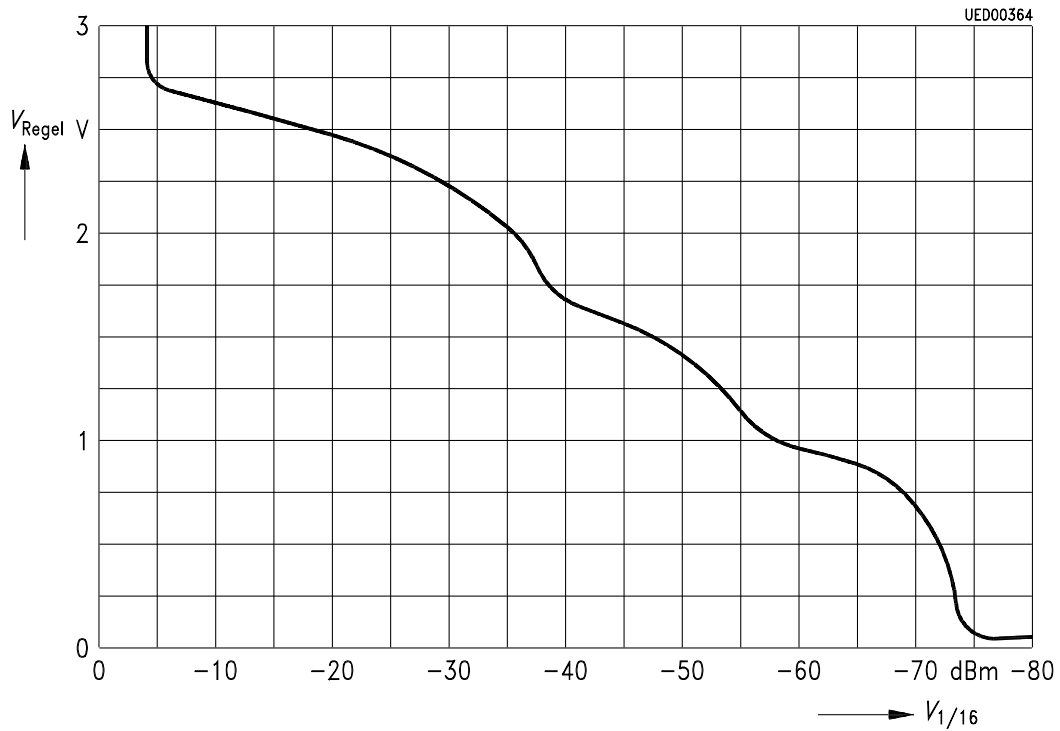

Inset Point AGC Voltage

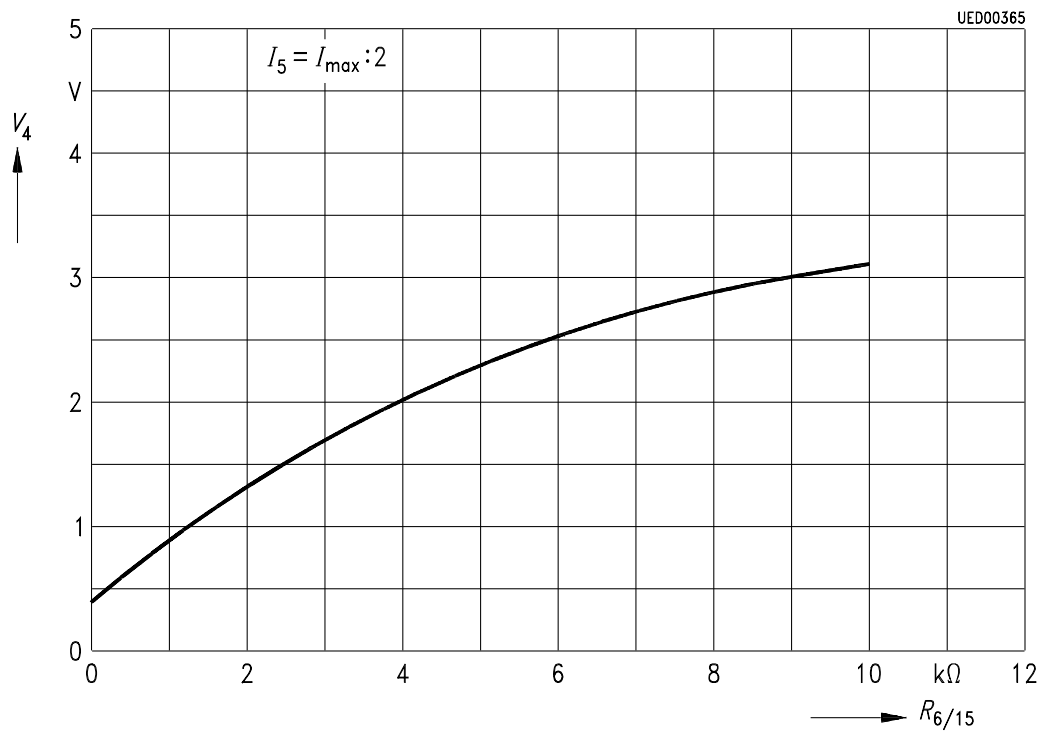

Tuner AGC Current

$I_5 = f(V_4)$

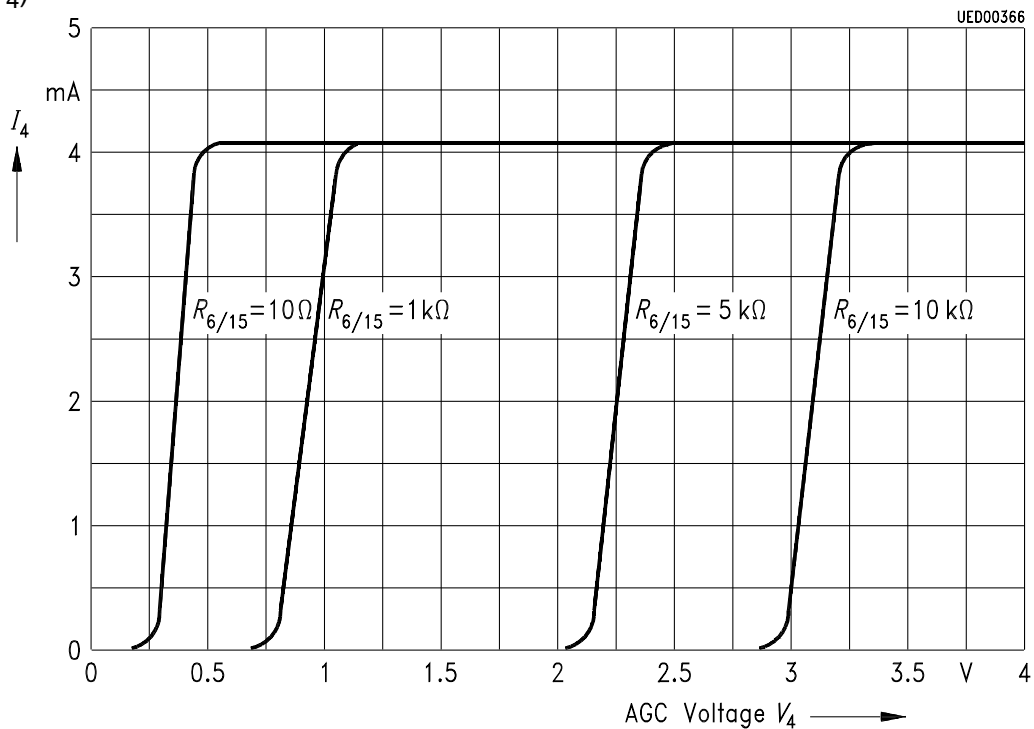

Low-Pass Cut-Off Frequency (pin 10)

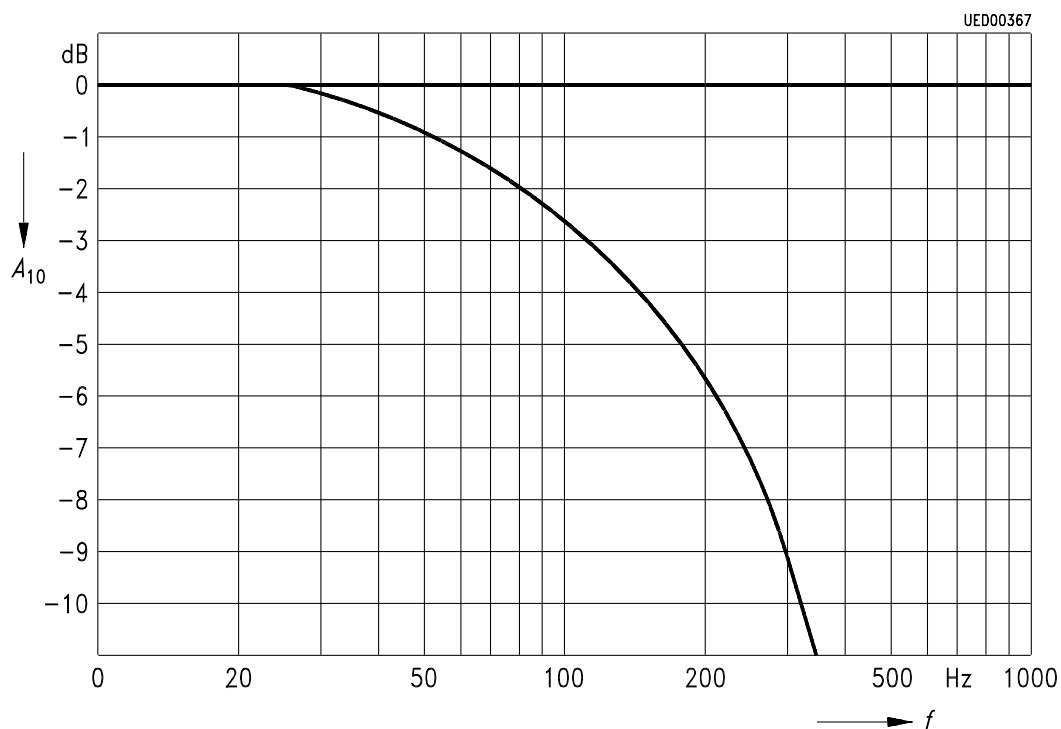

Measurement condition: ext. modulation: 10 Hz – 1 kHz sine 30 % AM
 video generator: ext. negative setup on half sync level, field off

AGC Time Constant Neg. Modulation

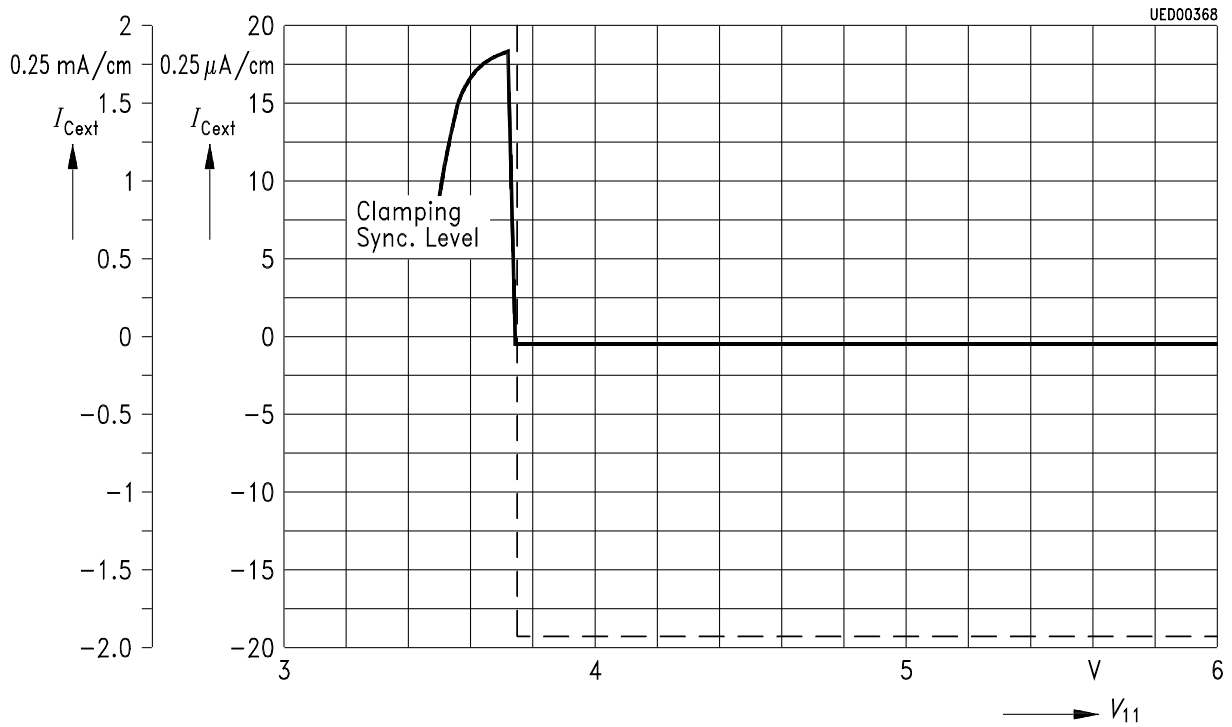

AGC Time Constant Pos. Modulation

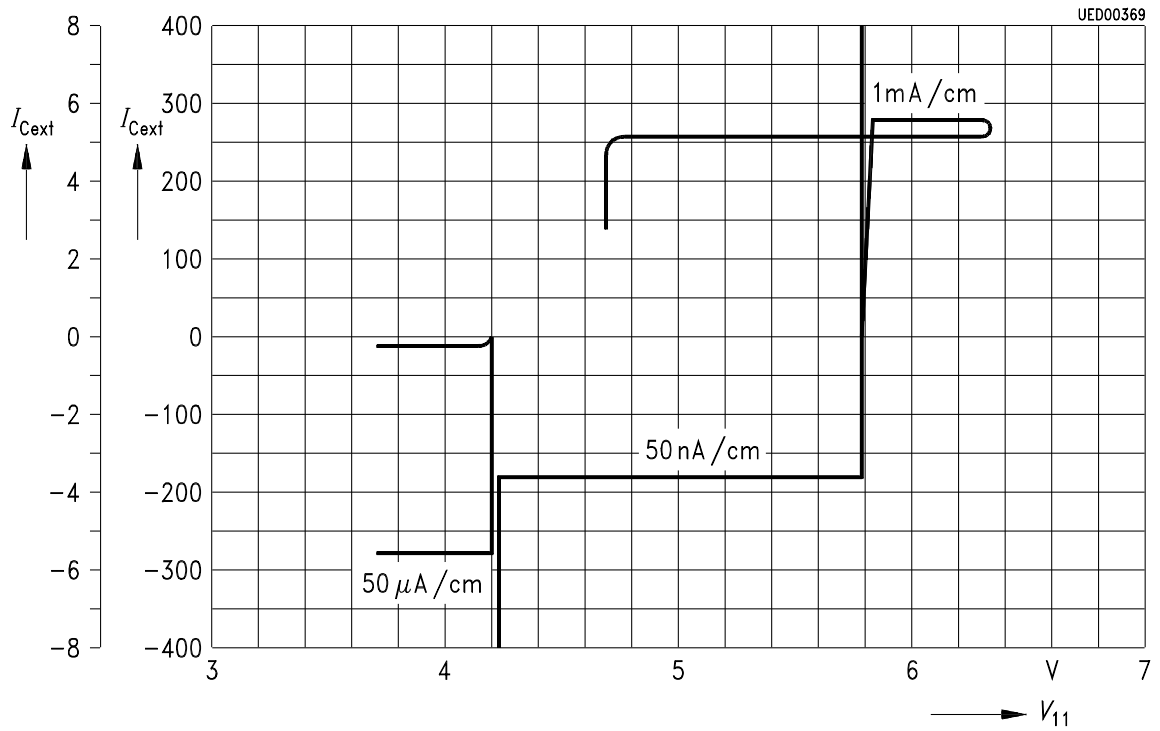

Pos. Video Output (pin 11)

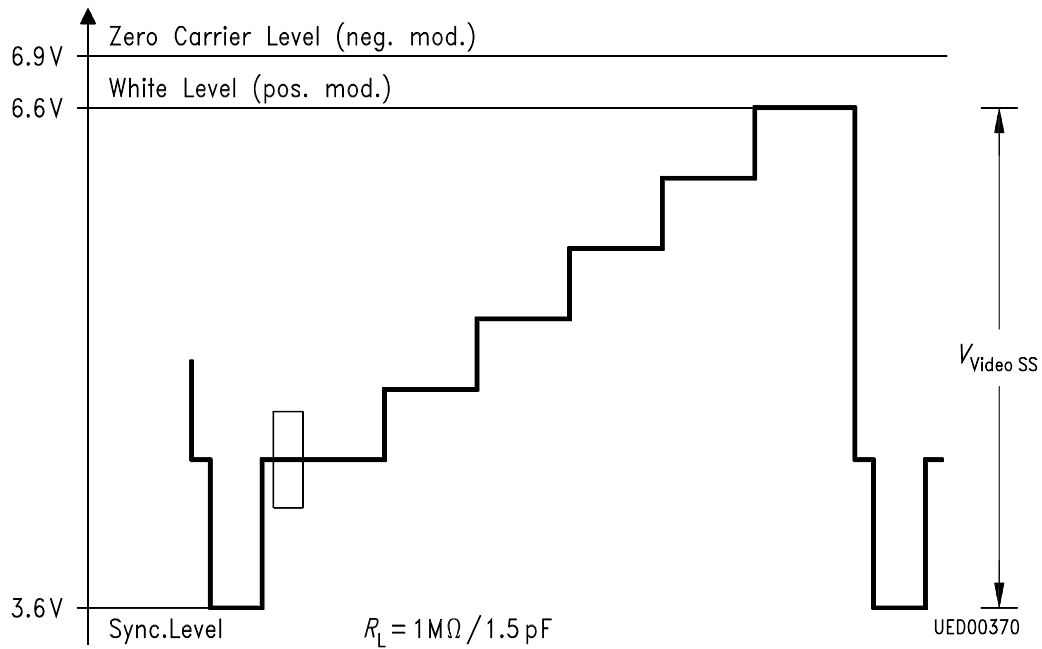

Neg. Video Output (pin 12)

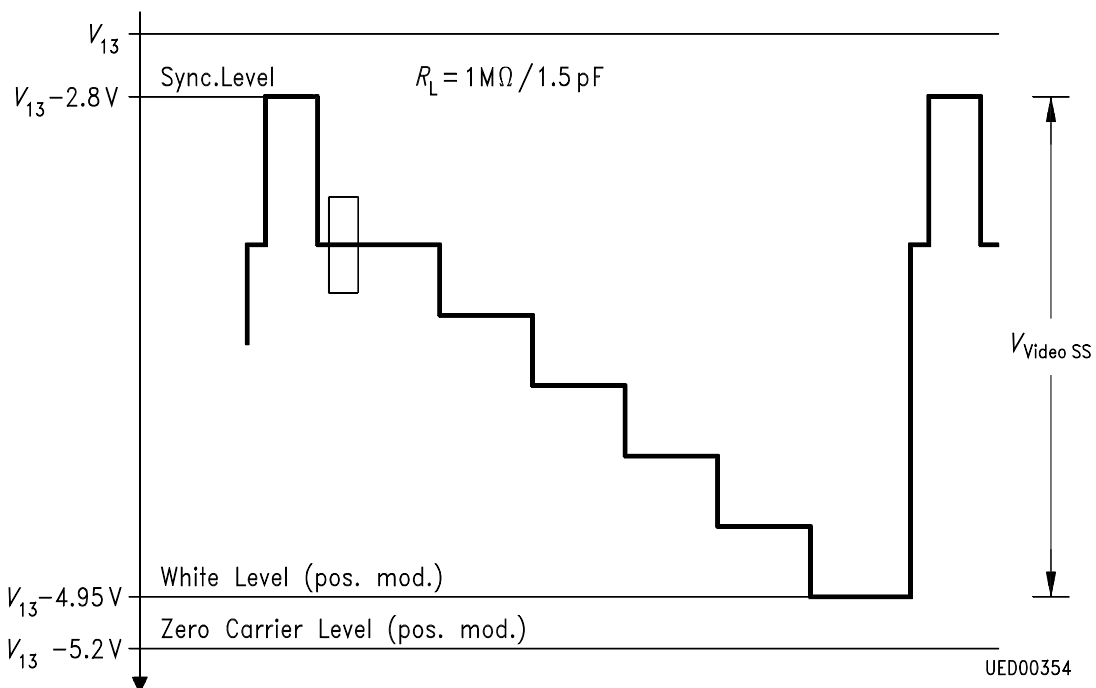

Voltage Dependent Load at Video Output

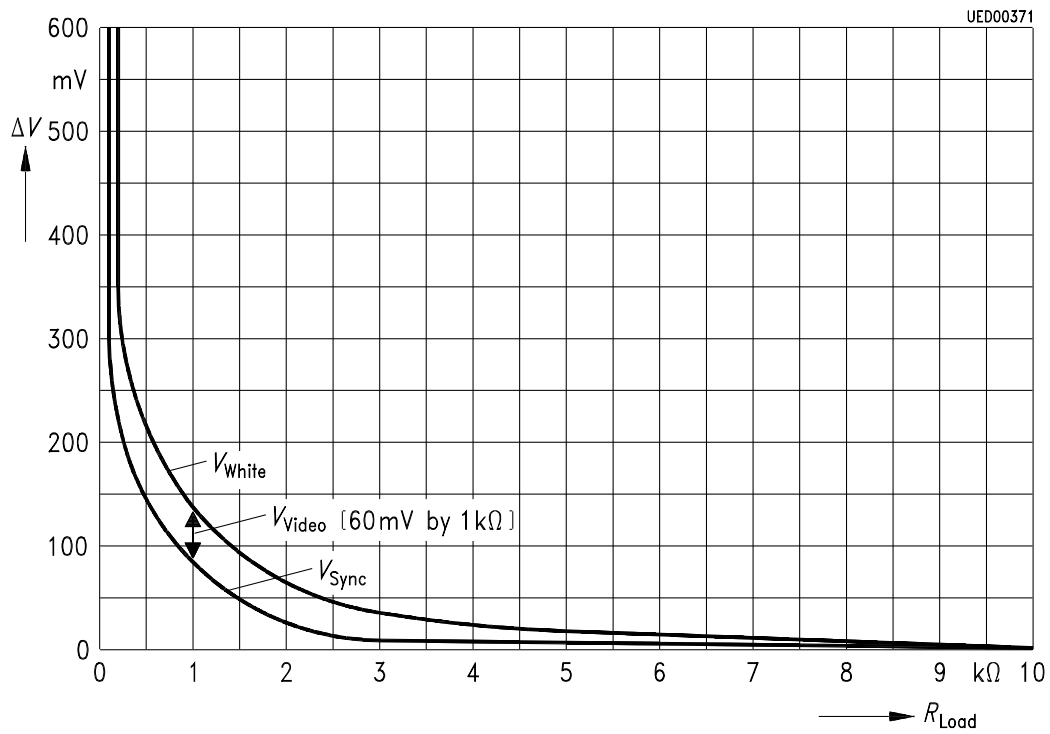

Switching Voltage

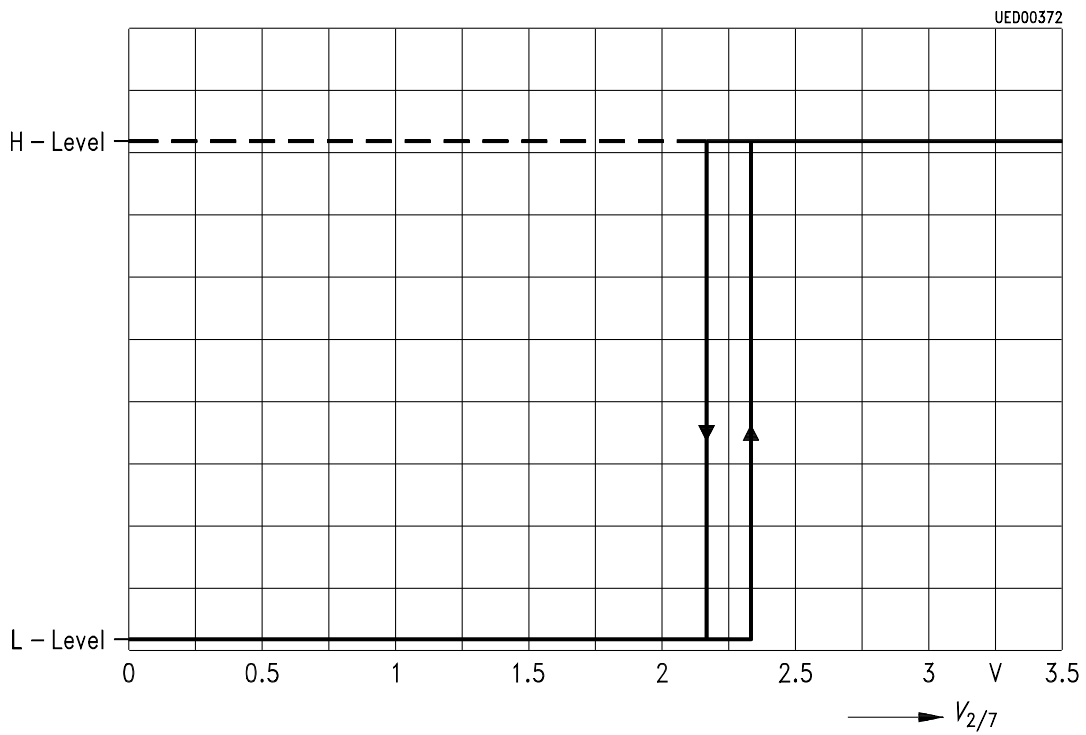

Inter-carrier Interference Voltage
(weighted according to CCIR 468)

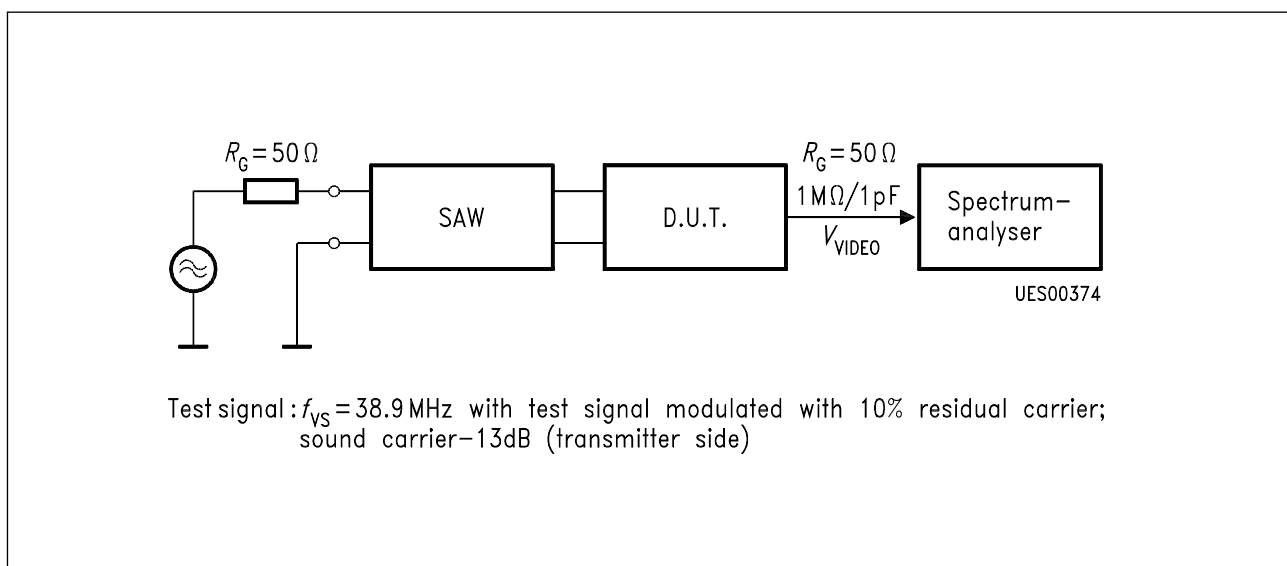
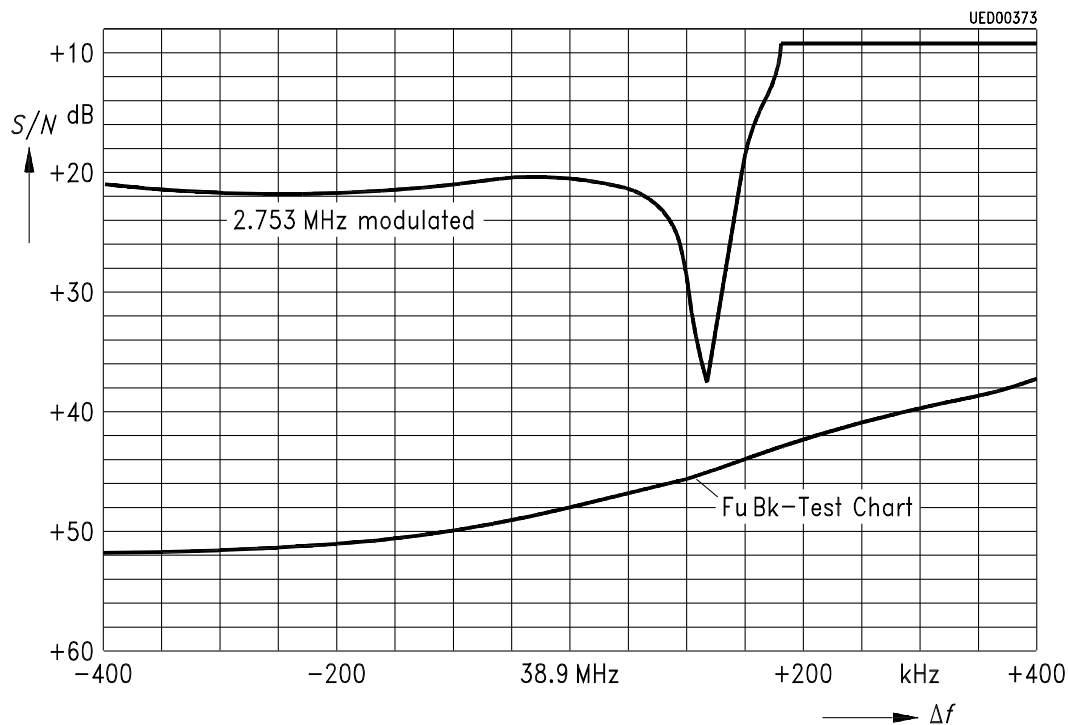

Measurement Configuration