

SOUND IF AMPLIFIER

- QUADRATURE INTERCARRIER DEMODULATOR
- VERY HIGH INPUT SENSITIVITY
- GOOD SIGNAL TO NOISE RATIO
- FAST AVERAGING AGC
- IF AMPLIFIER CAN BE SWITCHED OFF FOR VTR MODE
- GOOD AM SUPPRESSION
- OUTPUT SIGNAL STABILIZED AGAINST SUPPLY VOLTAGE VARIATIONS
- VERY FEW EXTERNAL COMPONENTS

DESCRIPTION

TDA4445A:
Sound IF amplifier, with FM processing for quasi parallel sound system.

TDA4445B:
Sound IF amplifier, with FM processing and AM demodulator, for multi-standard sound TV appliances.

TDA4445B additional:
Bistandard applications (B/G and L)
No adjustment of the AM demodulator
Low AM distortion

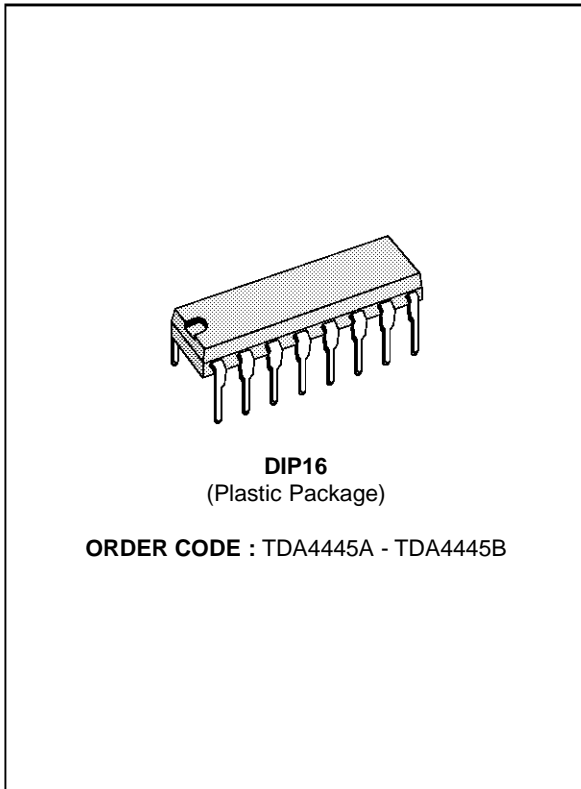

PIN CONNECTIONS

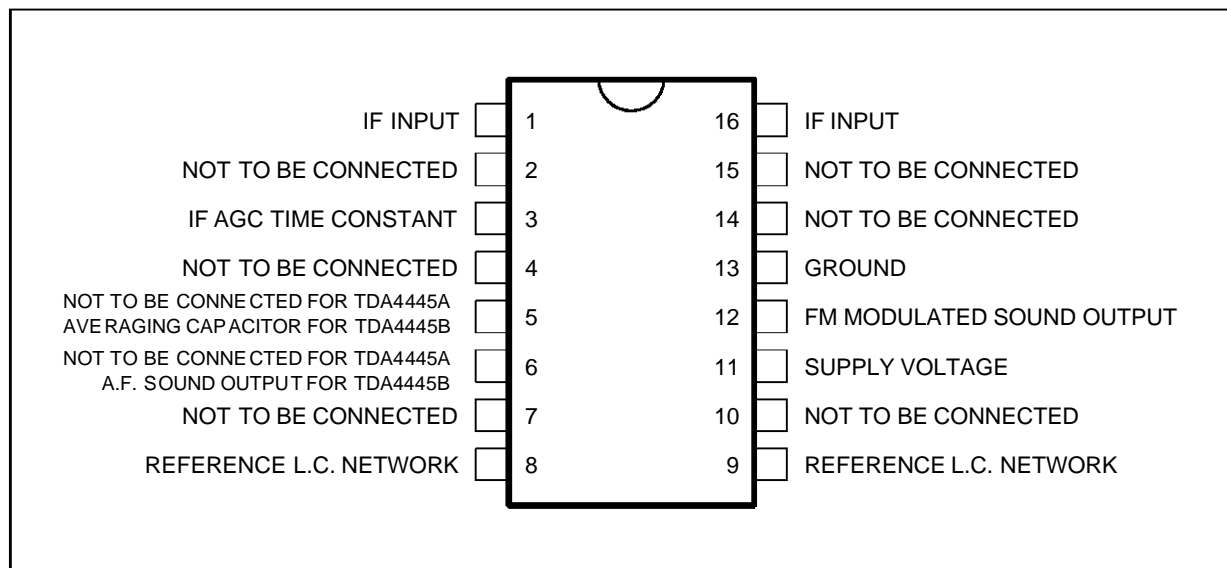

4445-01EPS

BLOCK DIAGRAMS

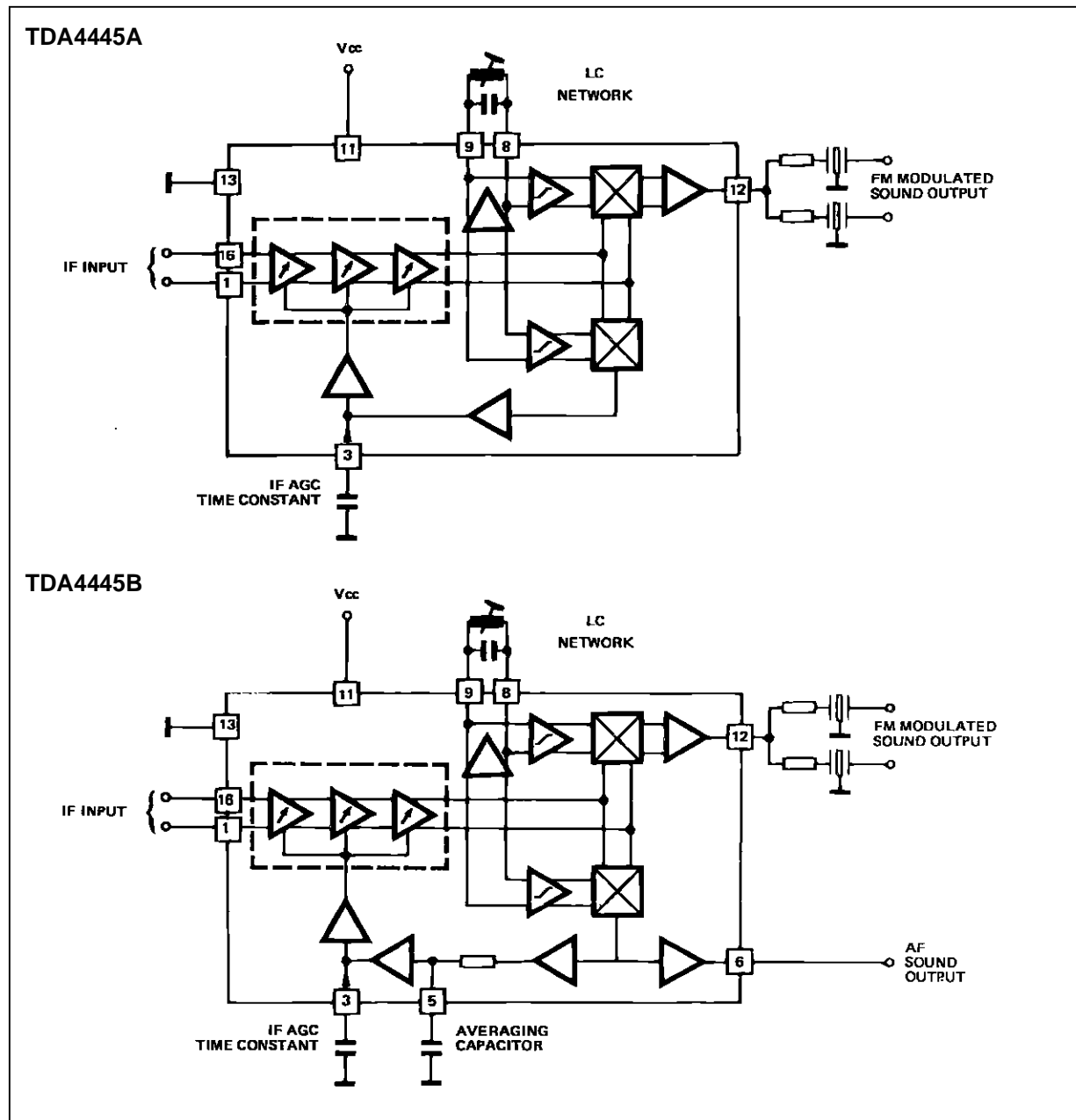

4445-02.EPS / 4445-03.EPS

GENERAL DESCRIPTION

This circuit includes the following functions :

- Three symmetrical and gain controlled wide band amplifier stages, which are extremely stable by quasi DC coupling without feedback.
- Averaging AGC with discharge control circuit
- AGC voltage generator

Quasi parallel sound operation :

- High phase accuracy of the carrier signal processing, independent from AM

essing, independent from AM

- Linear quadrature demodulator
- Sound-IF-amplifier stage with impedance converter

AM-Demodulation (only TDA4445B) :

- Carrier controlled demodulator
- Audio frequency stage with impedance converter
- Averaging low pass AGC

ABSOLUTE MAXIMUM RATINGS

Symbol	Parameter		Value	Unit	
V _{CC}	Supply Voltage Range	Pin 11	15	V	
I _{CC}	Supply Current	Pin 11	70	mA	
V _{ext}	External Voltages	Pin 3 Pin 12	12 8	V V	
V _{ext}	External Voltages	TDA4445A - TDA4445B TDA4445B	Pin 5 Pin 6	8 8	V V
P _{tot}	Power Dissipation		1	W	
T _j	Junction Temperature		125	°C	
T _{amb}	Ambient Temperature Range		0, + 70	°C	
T _{stg}	Storage Temperature Range		- 25, + 125	°C	

4445-01.TBL

THERMAL DATA

Symbol	Parameter	Value	Unit
R _{th(j-a)}	Junction-ambient Thermal Resistance	70	°C/W

4445-02.TBL

ELECTRICAL OPERATING CHARACTERISTICS

T_{amb} = + 25°C, V_{CC} = 12V (unless otherwise specified)

Symbol	Parameter	Min.	Typ.	Max.	Unit
--------	-----------	------	------	------	------

DC CHARACTERISTICS

V _{CC}	Supply Voltage	Pin 13	10	12	15	V
I _{CC}	Supply Current (V ₃ = 3.5V)	Pin 11		45	60	mA
V _O	DC Output Voltage (V ₃ = 3.5V)	Pin 12	4.25	5	5.75	V
I	Output DC Current (V ₃ = 3.5V, V ₁₁ = 12V)	Pin 12	1		2	mA
R	Input Impedance	Pins 1-16		2		kΩ
C	Input Impedance	Pins 1-16		2		pF
V	Switch off Control Voltage for VTR Mode	Pin 3	9		10	V
I	Switch off Control Current for VTR Mode	Pin 3			150	μA

AGC CHARACTERISTICS

Δ _{GIF}	IF AGC Range		62		dB
------------------	--------------	--	----	--	----

QUASI PARALLEL SOUND OPERATION

(f_{PC} = 38.9MHz, f_{SC1} = 33.4MHz, f_{SC2} = 33.16MHz, PC/SC₁ = 13dB, PC/SC₂ = 20dB, PC unmodulated)

V _I	Min. Input Voltage (5.5MHz - Output Signal - 3dB)	Pins 1-16		70		μV _{eff}
V _I	Max. Input Voltage (5.5MHz - Output Signal + 1dB)	Pins 1-16		90		mV _{eff}
V _O	Sound-IF-output Voltage (V ₁₋₁₆ = 20mV _{eff} SC unmodulated)	Pin 12				
	5.5MHz Output Voltage		200		400	mV _{eff}
	5.74MHz Output Voltage		100		300	mV _{eff}
	Signal to noise ratio measured according to CCIR 468-2 Picture Modulation Ratio 90%, Reference signal (V ₁₋₁₆ = 10mV), FM-frequency deviation 30kHz → Out 1 350mV _{RMS} f _{mod} = 1kHz, measured at audio-output Out 2 350mV _{RMS}	Pin 12				
$\frac{S+N}{N}$	Black Screen (1. Channel/2. Channel)			55/50		dB
	Grid Screen (1. Channel/2. Channel)			45/40		dB

AM DEMODULATION (TDA4445B only) (f_{SC} = 39.2MHz, m = 80%, f_{mod} = 1kHz)

V _I	Min. Input Voltage (Audio Output Signal - 3dB)	Pins 1-16		70		μV _{eff}
V _O	Output DC Voltage (V ₁₋₁₆ = 10mV _{eff} unmodulated)	Pin 6	3.3		4.5	V
I	Output DC Current (V ₆ = 7.5V, V ₃ = 3.5V)	Pin 6	0.3		1.2	mA
d	Distortion (V ₁₋₁₆ = 10mV, f _{mod} = 1kHz, m = 80%)	Pin 6		2.5	4	%
V _O	AF Output Voltage (V ₁₋₁₆ = 100mV _{eff} , m = 50%, f _{mod} = 10kHz)	Pin 6	500	700	900	mV _{eff}

4445-03.TBL

TDA4445A - TDA4445B

TYPICAL APPLICATION

Figure 1 : Quasi Parallel Sound Operation

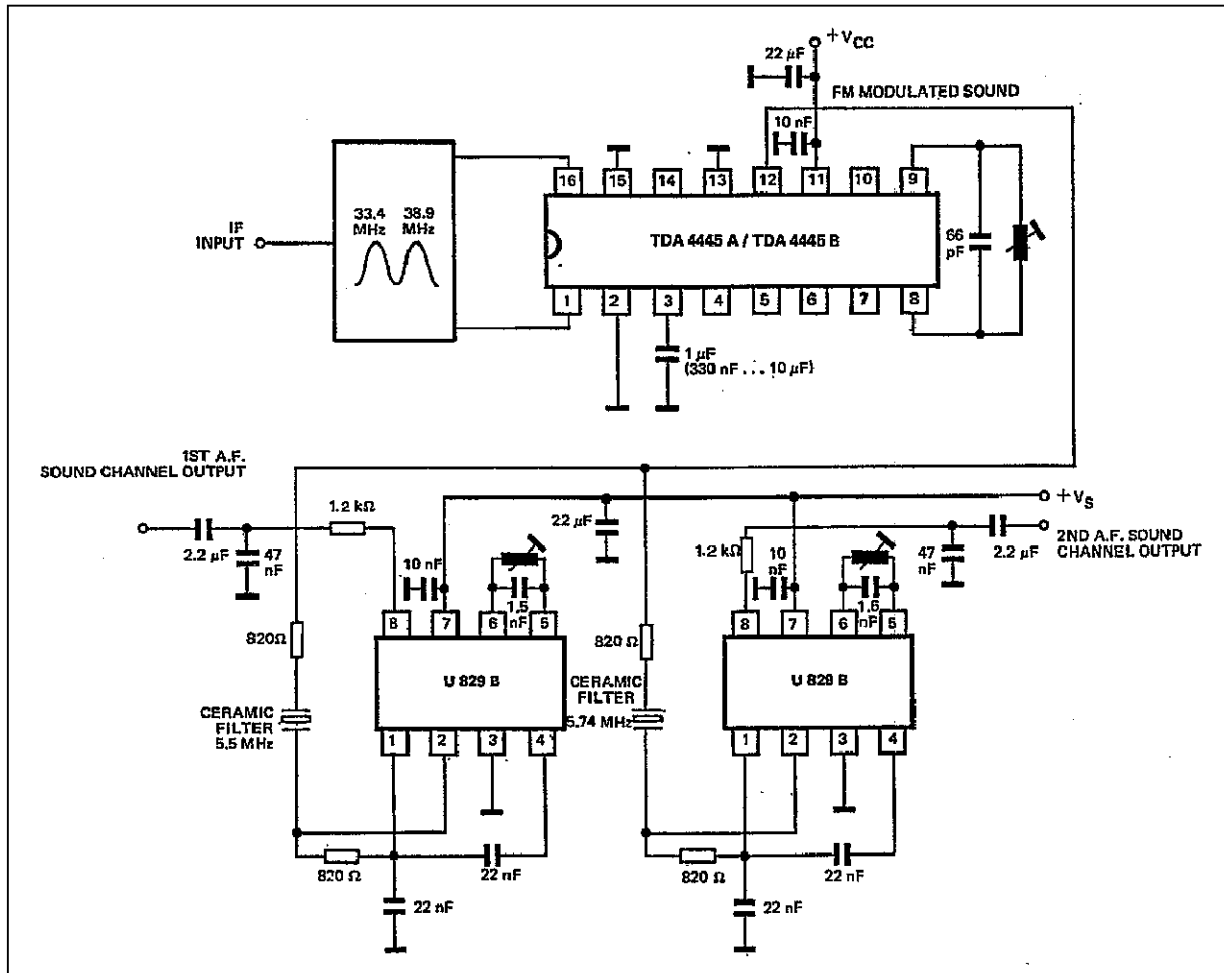

4445-04.TIF

TYPICAL APPLICATION

Figure 2 : Bistandard Operation (FM stereo sound + AM sound)

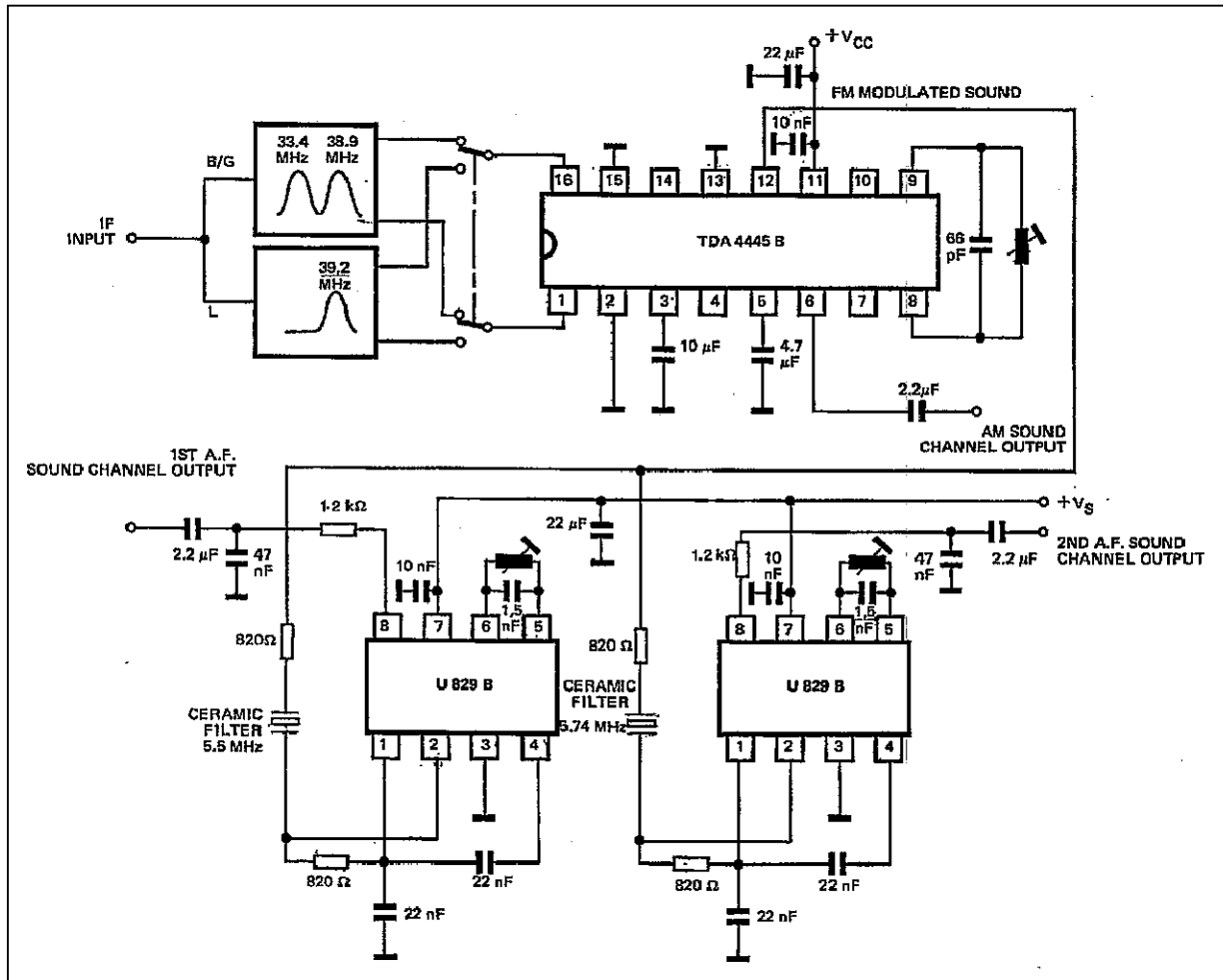

4445-05.TIF

TDA4445A - TDA4445B

PACKAGE MECHANICAL DATA

16 PINS - PLASTIC DIP

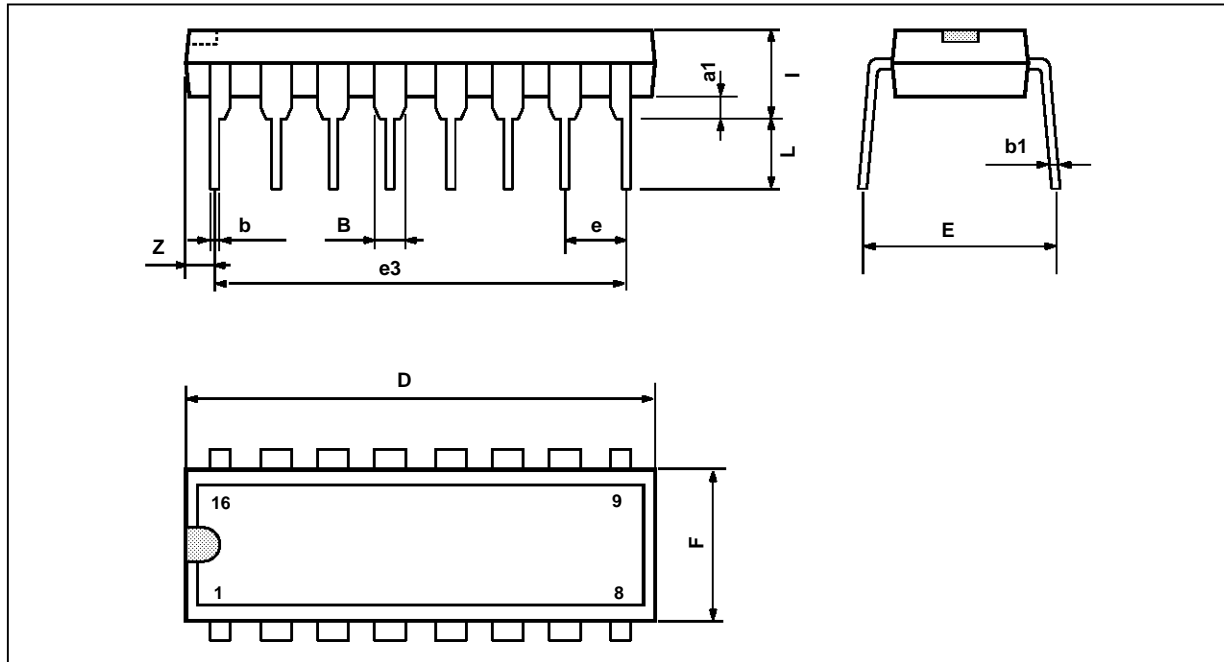

Dimensions	Millimeters			Inches		
	Min.	Typ.	Max.	Min.	Typ.	Max.
a1	0.51			0.020		
B	0.77		1.65	0.030		0.065
b		0.5			0.020	
b1		0.25			0.010	
D			20			0.787
E		8.5			0.335	
e		2.54			0.100	
e3		17.78			0.700	
F			7.1			0.280
i			5.1			0.201
L		3.3			0.130	
Z			1.27			0.050

Information furnished is believed to be accurate and reliable. However, SGS-THOMSON Microelectronics assumes no responsibility for the consequences of use of such information nor for any infringement of patents or other rights of third parties which may result from its use. No licence is granted by implication or otherwise under any patent or patent rights of SGS-THOMSON Microelectronics. Specifications mentioned in this publication are subject to change without notice. This publication supersedes and replaces all information previously supplied. SGS-THOMSON Microelectronics products are not authorized for use as critical components in life support devices or systems without express written approval of SGS-THOMSON Microelectronics.

© 1994 SGS-THOMSON Microelectronics - All Rights Reserved

Purchase of I²C Components of SGS-THOMSON Microelectronics, conveys a license under the Philips I²C Patent. Rights to use these components in a I²C system, is granted provided that the system conforms to the I²C Standard Specifications as defined by Philips.

SGS-THOMSON Microelectronics GROUP OF COMPANIES

Australia - Brazil - China - France - Germany - Hong Kong - Italy - Japan - Korea - Malaysia - Malta - Morocco
The Netherlands - Singapore - Spain - Sweden - Switzerland - Taiwan - Thailand - United Kingdom - U.S.A.