

# TA7616P

T-77-05-05

## CAR RADIO AM TUNER ONE CHIP AM SYSTEM

- . Stable Operation at High Input Signal .
- . Wide Operating Supply Voltage Range:  
VCC=7~15V, Recommend VCC=9V
- . Small Noise at Detune.
- . AM RF, AM MIX. and AM OSC Amplifiers.
- . AM IF, Detector and AGC Circuits.

### MAXIMUM RATINGS (Ta=25°C)

CHARACTERISTIC	SYMBOL	RATING	UNIT
Supply Voltage	VCC	16	V
Power Dissipation (Note)	P <sub>D</sub>	750	mW
Operating Temperature	T <sub>opr</sub>	-30 ~ 75	°C
Storage Temperature	T <sub>stg</sub>	-55 ~ 150	°C

Note: Derated above Ta=25°C in the proportion of 6mW/°C.

Unit in mm

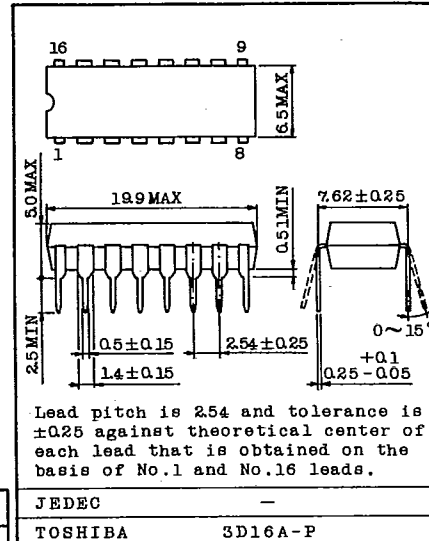

### BLOCK AND TERMINAL DIAGRAMS

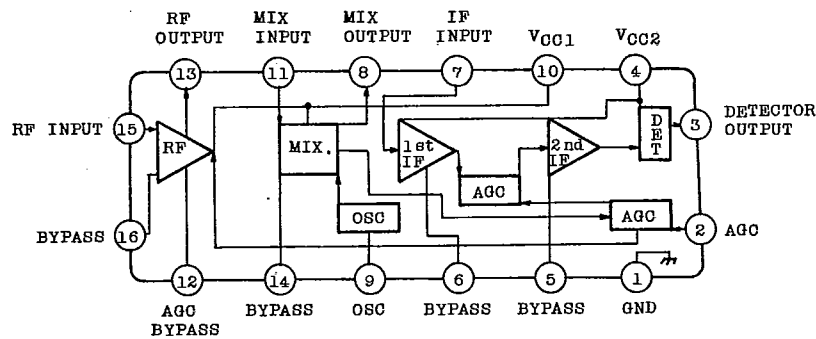

AUDIO LINEAR IC

## ELECTRICAL CHARACTERISTICS

(Unless otherwise specified,  $V_{CC}=9V$ ,  $f_S=1MHz$ ,  $f_M=400Hz$ ,  $Mod=30%$ ,  $f_F=455kHz$ ,  $T_a=25^{\circ}C$ )

CHARACTERISTIC		SYMBOL	TEST CIR-CUIT	TEST CONDITION	MIN.	TYP.	MAX.	UNIT	
Supply Current		$I_{CC}$	1	-	9	13	20	mA	
Recovered Output Voltage		$V_{OD}$	1	$V_{IN}=74dB\mu V$	55	84	110	$mV_{RMS}$	
Maximum Sensitivity		$MS$	1	$V_{OD}=20mV_{RMS}$	-	9	-	$dB\mu V$	
Quieting Sensitivity		$QS$	1	$S/N=20dB$	-	24	30	$dB\mu V$	
Signal to Noise Ratio		$S/N$	1	$V_{IN}=74dB\mu V$	46	52.5	-	dB	
Total Harmonic Distortion		$THD(1)$	1	$V_{IN}=74dB\mu V$	-	0.3	3	%	
		$THD(2)$	1	$V_{IN}=74dB\mu V$ $Mod=80%$	-	0.6	-		
		$THD(3)$	1	$V_{IN}=120dB\mu V$	-	0.5	-		
Tweet		Tweet	1	$V_{IN}=74dB\mu V$	2IF	-	-35	-	dB
				Max. Point	3IF	-	-40	-	
Pin 15 Input Impedance	Parallel Input Resistance	$R_{ip15}$	2	$f=1000kHz$	-	6.6	-	$k\Omega$	
	Parallel Input Capacitance	$C_{ip15}$			-	3	-	pF	
Pin 13 Output Impedance	Parallel Output Resistance	$R_{op13}$	3	$f=1000kHz$	-	100	-	$k\Omega$	
	Parallel Output Capacitance	$C_{op13}$			-	1.4	-	pF	
Pin 11 Input Impedance	Parallel Input Resistance	$R_{ip11}$	4	$f=1000kHz$	-	2.2	-	$k\Omega$	
	Parallel Input Capacitance	$C_{ip11}$			-	7.5	-	pF	
Pin 8 Output Impedance	Parallel Output Resistance	$R_{op8}$	5	$f=455kHz$	-	100	-	$k\Omega$	
	Parallel Output Capacitance	$C_{op8}$			-	3.5	-	pF	
Pin 7 Input Impedance	Parallel Input Resistance	$R_{ip7}$	6	$f=455kHz$	-	3.5	-	$k\Omega$	
	Parallel Input Capacitance	$C_{ip7}$			-	8	-	pF	

# TA7616P

T-77-05-05

## TEST CIRCUIT

1.  $I_{CC}$ ,  $V_{OD}$ , MS, QS, S/N, THD, Tweet

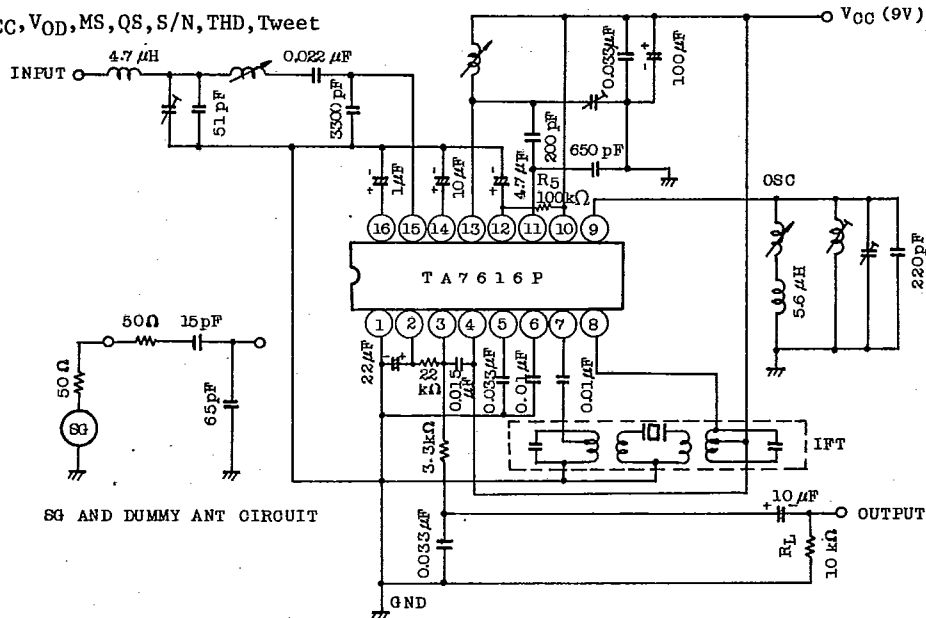

## COIL DATA

1. OSC COIL "L"

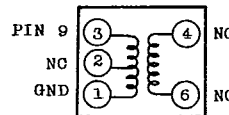

L = 220 μH STANDARD		
Q ≥ 80 at 796 kHz		
① ~ ② 10 T	① ~ ③ 98 T	④ ~ ⑥ 39 T

DENKEN Co., 4691 OR EQUIVALENT

2. IFT

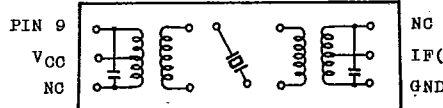

TOKO Co.,  
CFT-455A OR EQUIVALENT IFT  
LF (PIN 7) CENTER FREQUENCY  $455 \pm 3.5$  kHz

3. AM TUNNER COIL

MITSUMI Co., CMM ZT-02 OR EQUIVALENT TUNNER COIL.  
TUNING FREQUENCY RANGE  $520 \sim 1660 \pm 40$  kHz

BOTTOM VIEW

AUDIO LINEAR IC

# TA7616P

T-77-05-05

2.  $R_{ip15}, C_{ip15}$

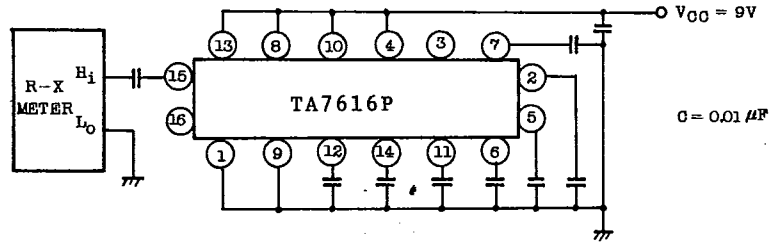

3.  $R_{op13}, C_{op13}$

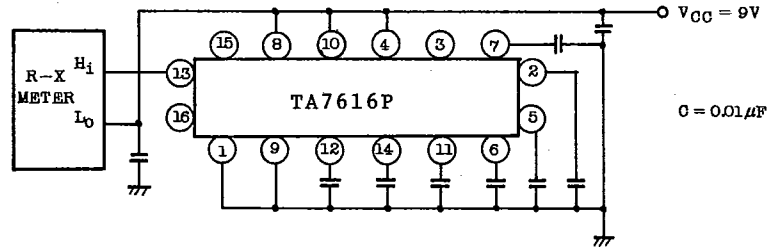

4.  $R_{ip11}, C_{ip11}$

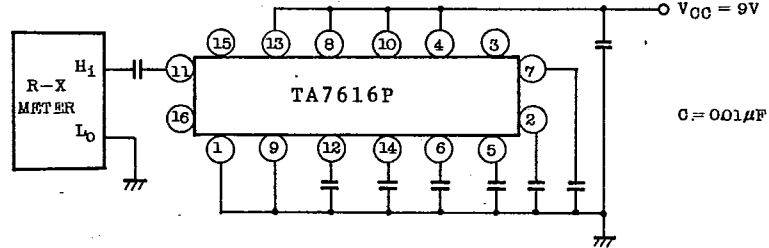

5.  $R_{op8}, C_{op8}$

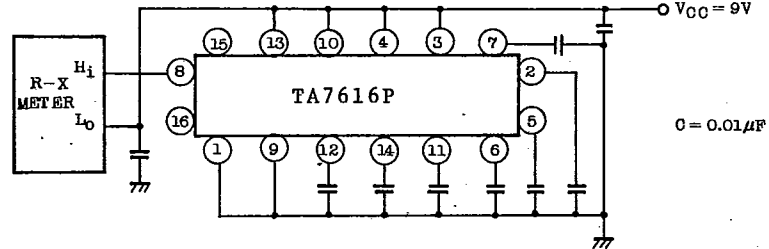

6.  $R_{ip7}, C_{ip7}$

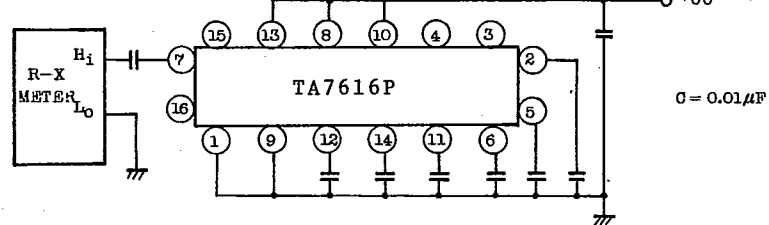

**TOSHIBA**

# TA7616P

T-77-05-05

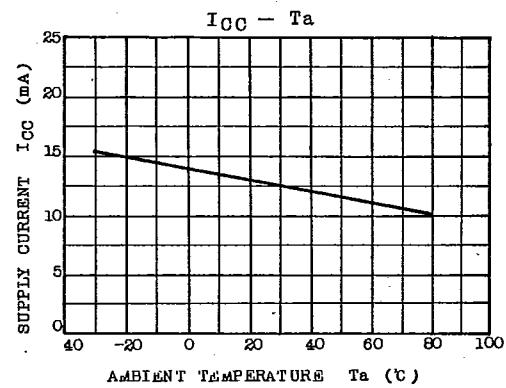
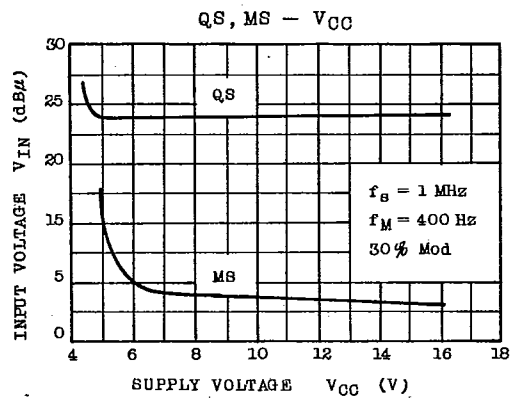
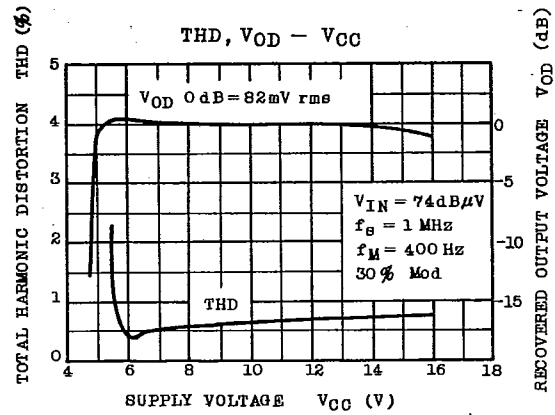
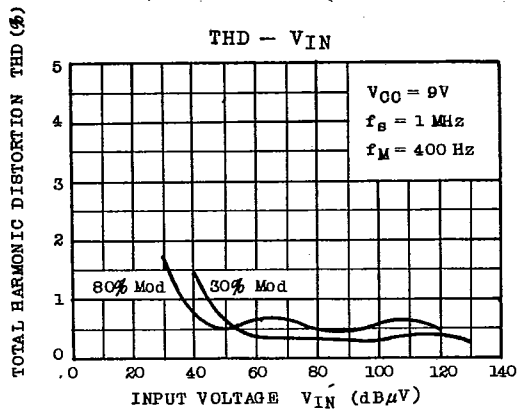
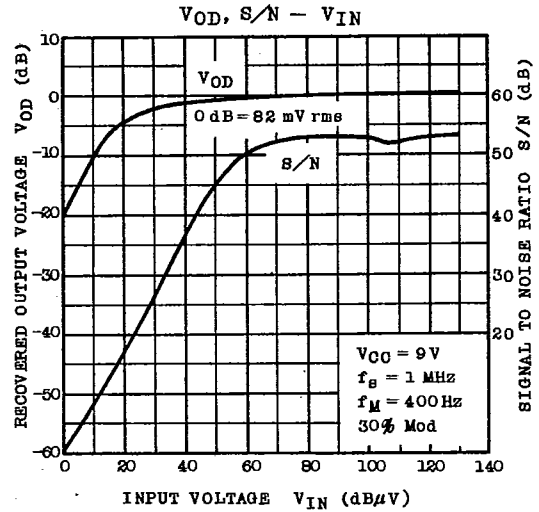
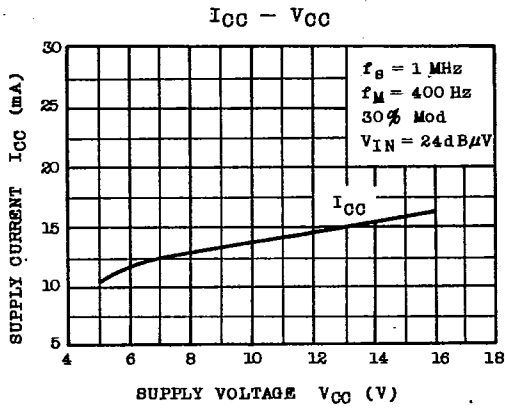

**AUDIO LINEAR IC**

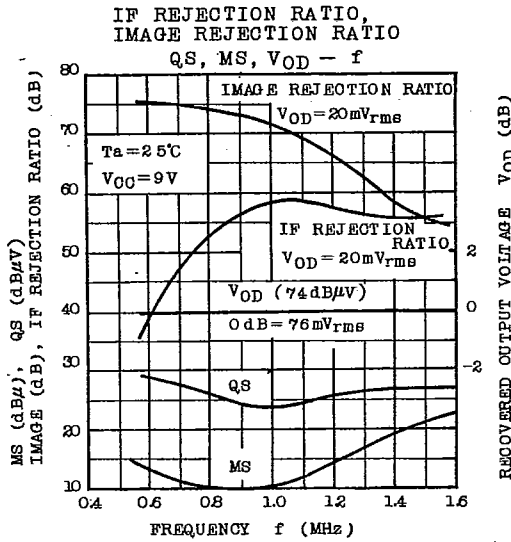
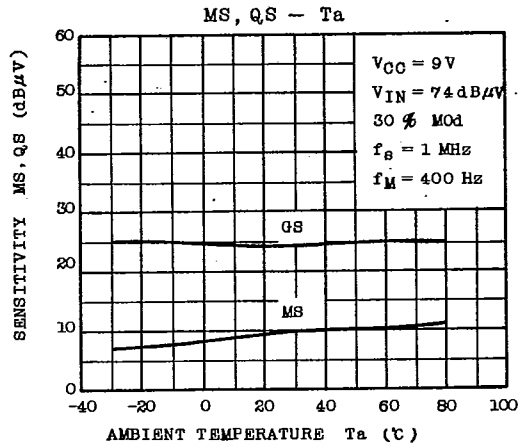
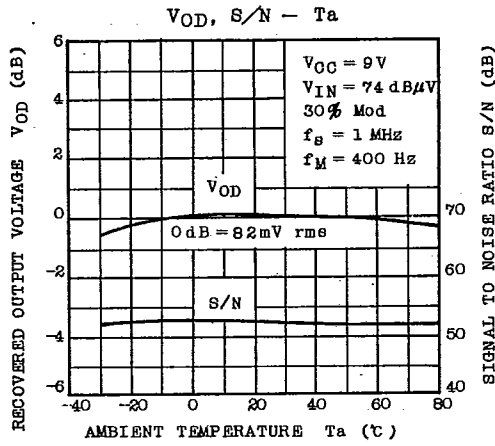

**2 SIGNAL CHARACTERISTIC -3dB SIGNAL SUPPRESSION EFFECT**

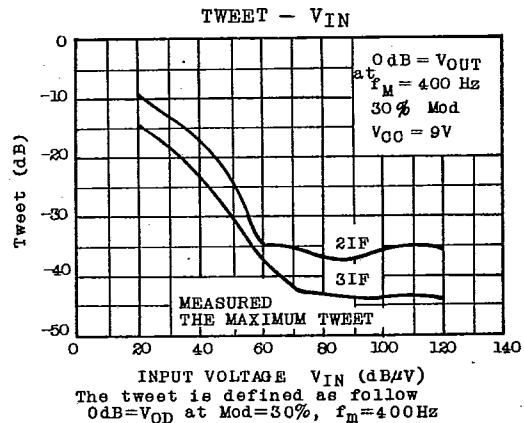
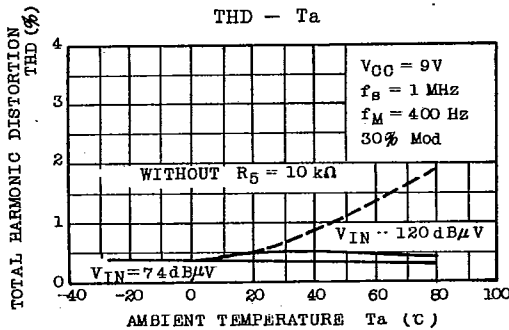
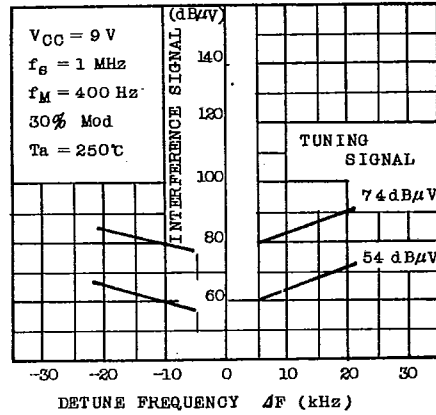

# TA7616P

T-77-05-05

## APPLICATION CIRCUIT

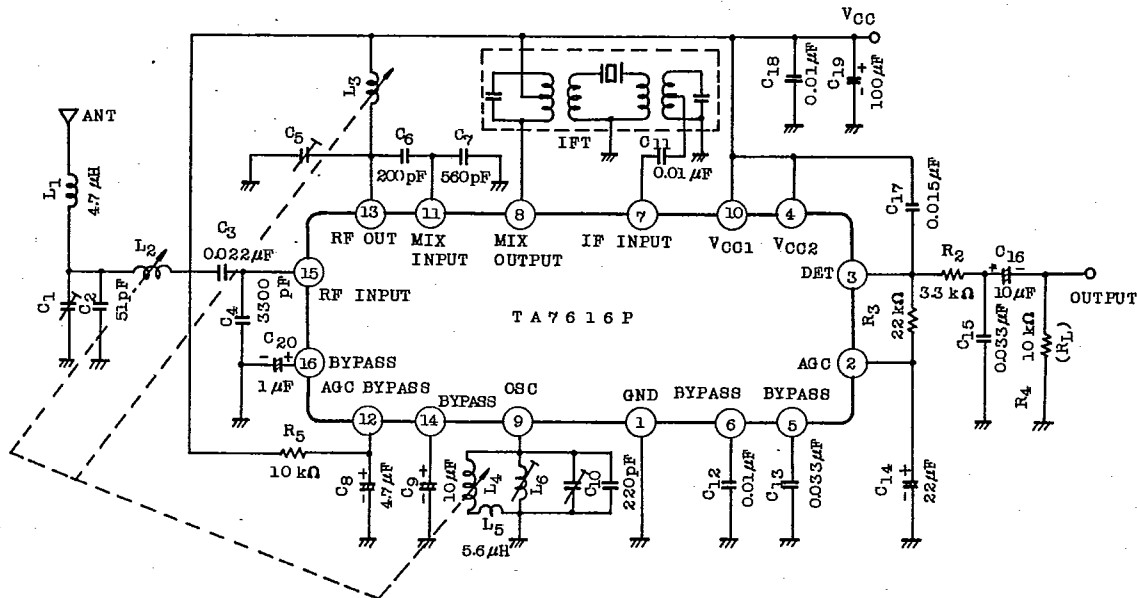

(NOTE) IFT : TOKO OFT-455A

### NOTE :

1. To avoid the instability ( especially tweet problem ), capacitor C<sub>17</sub> must be placed near by 3 pin and 4 pin.
2. Inductor L<sub>1</sub> is the noise radiation suppressor from antenna.
3. Capacitor C<sub>6</sub> and C<sub>7</sub> must be selected so that the injection level of the mixer stage will be optimum value.
4. AGC by-passing capacitor C<sub>14</sub> and C<sub>8</sub> determine AGC response speed.  
So, large value will cause slow response and too small value will cause poor distortion characteristics at low frequency.
5. Resistor R<sub>5</sub> assures low distortion characteristics ( THD = 1% ) at all operation temperature range.

AUDIO LINEAR IC