

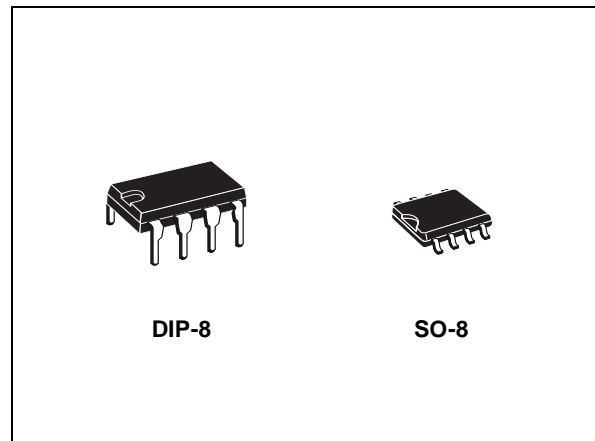

ST777/778/779

LOW VOLTAGE INPUT, 3-3.3V/5V/ADJUSTABLE OUTPUT DC-DC CONVERTER WITH SYNCHRONOUS RECTIFIER

- 1V TO 6V INPUT GUARANTEES START-UP UNDER LOAD
- MAXIMUM OUTPUT CURRENT OF 300mA (778 OR 779 ADJUSTED TO 3V)
- LOAD FULLY DISCONNECTED IN SHUTDOWN
- TYPICAL EFFICIENCY OF 82%
- INTERNAL 1A POWER SWITCH AND SYNCHRONOUS RECTIFIER
- ADJUSTABLE CURRENT LIMIT ALLOWS LOW-COST INDUCTORS
- SUPPLY CURRENT OF 270 μ A (NO LOAD)
- SHUTDOWN SUPPLY CURRENT 20 μ A
- PACKAGE AVAILABLE: DIP-8 AND SO-8



DESCRIPTION

The ST777/778/779 are dc-dc converters that step-up from low voltage inputs requiring only three external components, an inductor (typically 22 μ H) and two capacitors. The device include a Synchronous Rectifier that eliminates the need for an external catch diode, and allows regulation even when the input is greater than the output.

Unlike others step-up DC-DC converters the ST777/778/779's Synchronous Rectifier turns off in the shutdown mode, fully disconnecting the output from the source. This eliminates the current drain associated with conventional step-up converters when off or in shutdown. Supply current is 270 μ A under no load and only 20 μ A in stand by mode.

SCHEMATIC DIAGRAM

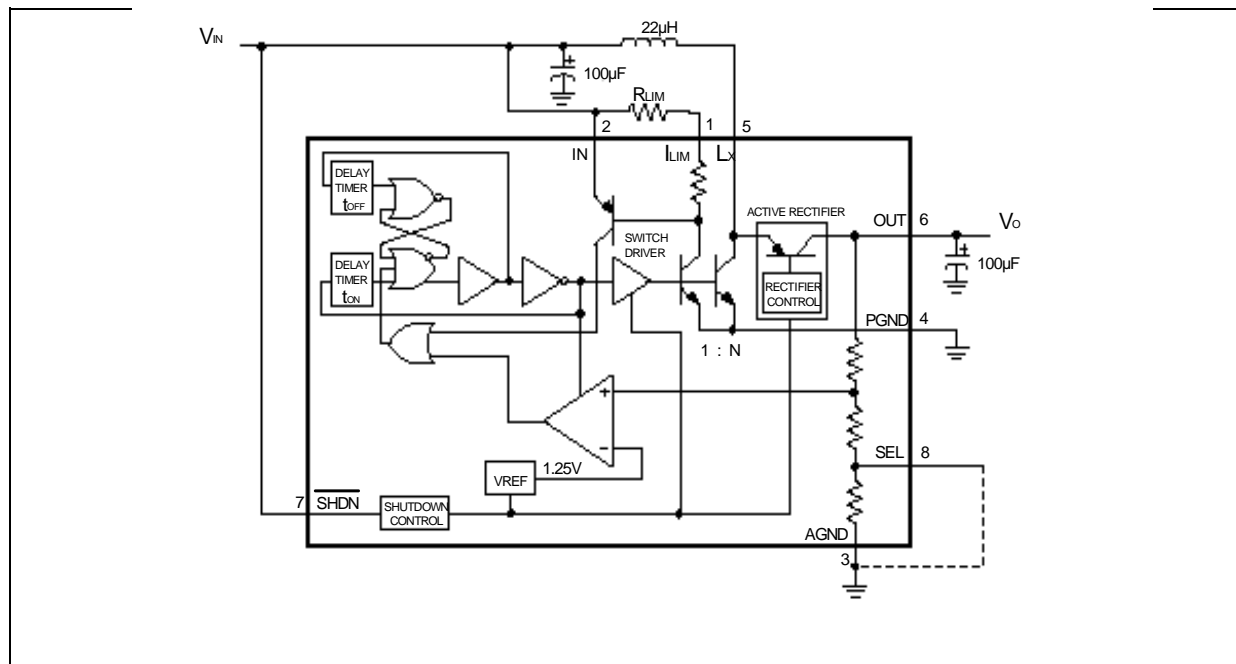

ABSOLUTE MAXIMUM RATINGS

Symbol	Parameter	Value	Unit
V _{CC}	DC Input Voltage to GND	-0.3 to +7	V
LX	Switch off Pin Voltage	-0.3 to +7	V
	Switch on Pin Voltage	30 sec short to IN or OUT	
OUT, SHDN	Output, Shutdown Voltage	-0.3 to +7	V
AGND to PGND	Analog and Power Ground	-0.3 to +0.3	V
FB	FB Pin Voltage	-0.3 to (OUT+0.3)	V
P _{TOT}	Continuous Power Dissipation (at T _A = 85°C) DIP-8	550	mW
	Continuous Power Dissipation (at T _A = 85°C) SO-8	344	
T _{STG}	Storage Temperature Range	-40 to 150	°C
T _{OP}	Operating Ambient Temperature Range	0 to 85	°C

Absolute Maximum Ratings are those values beyond which damage to the device may occur. Functional operation under these condition is not implied.

ORDERING CODES

TYPE	DIP-8	SO-8
ST777	ST777ACN	ST777ACD
ST778	ST778ACN	ST778ACD
ST779	ST779ACN	ST779ACD

CONNECTION DIAGRAM

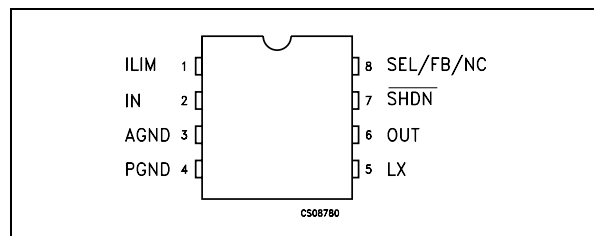

PIN CONNECTIONS

Pin No.	SYMBOL	NAME AND FUNCTION
1	ILIM	Sets switch current limit input. Connect to IN for 1A current limit. A resistor from ILIM to IN sets lower peak inductor currents.
2	IN	Input from battery
3	AGND	Analog ground. Not internally connected to PGND.
4	PGND	Power ground. Must be low impedance; solder directly to ground plane or star ground. Connect to AGND, close to the device.
5	LX	Collector of 1A NPN power switch and emitter of Synchronous Rectifier PNP.
6	OUT	Voltage Output. Connect filter capacitor close to pin.
7	SHDN	Shutdown input disables power supply when low. Also disconnects load from input. Threshold is set at V _{IN} /2.
8	SEL/N.C./FB	- Selection pin for 3/3.3V version (778); - Not internally connected for 5V version (777); - Feedback pin for adjustable version (779).

THERMAL DATA

Symbol	Parameter	DIP-8	SO-8	Unit
R _{thj-amb}	Thermal Resistance Junction-ambient	100	160	°C/W

ELECTRICAL CHARACTERISTICS ($V_{IN}=2.5V$, $C_I = 22\mu F$, $C_O=100\mu F$, \overline{SHDN} and $ILIM$ connected to IN , $AGND$ connected to $PGND$, $T_A=0$ to $85^\circ C$, unless otherwise specified. Typical values are referred at $T_A=25^\circ C$)

Symbol	Parameter	Test Conditions	Min.	Typ.	Max.	Unit
V_{START}	Start up Voltage	$I_{LOAD} < 10mA$, $T_A = 25^\circ C$ (Note 1)			1	V
$V_{IN(MAX)}$	Maximum Input Voltage	(Note 1,2)	6			V
V_O	Output Voltage ST777 779 (set to 5V), (Note 3)	$I_{LOAD} \leq 30mA$, $V_{IN} = 1.1V$ to $5V$ or $I_{LOAD} \leq 80mA$, $V_{IN} = 1.8V$ to $5V$ or $I_{LOAD} \leq 130mA$, $V_{IN} = 2.4V$ to $5V$	4.8	5.0	5.2	V
	Output Voltage ST778 (Note 3)	$SEL=0V$ $I_{LOAD} \leq 50mA$, $V_{IN} = 1.1V$ to $3.3V$ or $I_{LOAD} \leq 210mA$, $V_{IN} = 1.8V$ to $3.3V$ or $I_{LOAD} \leq 300mA$, $V_{IN} = 2.4V$ to $3.3V$	3.17	3.30	3.43	V
		$SEL=OPEN$ $I_{LOAD} \leq 30mA$, $V_{IN} = 1.1V$ to $3V$ or $I_{LOAD} \leq 210mA$, $V_{IN} = 1.8V$ to $3V$ or $I_{LOAD} \leq 300mA$, $V_{IN} = 2.4V$ to $3V$	2.88	3.00	3.12	V
	Output Voltage Range ST779	(Note 4)	2.7		6.5	V
I_{IN}	No Load Supply Current	$I_{LOAD} = 0 mA$, (Switch ON) (Note 5)		270		μA
I_{SHDN}	Shutdown Supply Current	$SHDN=0V$, (Switch OFF)		20	35	μA
$I_{IN SHDN}$	Shutdown Input Current	$SHDN = 0$ to V_{IN}		15	100	nA
		$SHDN = V_{IN}$ to $5V$		12	40	μA
η	Efficiency	$I_{LOAD}=100mA$		82		%
V_{IH}	Shutdown Input Threshold	$V_{IN}=1V$ to $6V$		$V_{IN}/2 + 0.25$		V
I_{LIM}	Current Limit			1.0		A
$I_{LIM TEMPCO}$	Current Limit Temperature Coefficient			-0.3		%/ $^\circ C$
t_{OFFMIN}	Minimum Switch Off Time			1.2		μs
t_{ONMAX}	Maximum Switch ON Time	$V_{IN}=2.5V$		4.5		
		$V_{IN}=1.8V$		6.5		
		$V_{IN}=1V$		15		
$V_{CESAT NPN}$	Switch saturation Voltage	$I_{SW}=400mA$		0.25		V
		$I_{SW}=600mA$		0.33		
		$I_{SW}=1000mA$		0.5		
$V_{CESAT NPN}$	Rectifier Forward Drop	$I_{SW}=400mA$		0.18		V
		$I_{SW}=600mA$		0.22		
		$I_{SW}=1000mA$		0.4		
V_{FB}	Error Comparator Trip Point	ST779, over operating input voltage (Note 6)		$1.23 \pm 2\%$		V
I_{FB}	FB Pin Bias Current	ST779, $V_{FB}=1.3V$		50		nA
I_{LX}	Switch Off Leakage Current			0.1		μA
	Rectifier Off Leakage Current			0.1		μA

Note 1: Output in regulation, $V_{OUT} = V_{OUT} (\text{nominal}) \pm 4\%$.

Note 2: At high V_{IN} to V_{OUT} differentials, the maximum load current is limited by the maximum allowable power dissipation in the package.

Note 3: Start-up guaranteed under these load conditions.

Note 4: Minimum value is production tested. Maximum value is guaranteed by design and is not production tested.

Note 5: In the ST779 supply current depends on the resistor divider used to set the output voltage.

Note 6: V_{OUT} is set to a target value of +5V by 0.1% external feedback resistors. V_{OUT} is measured to be $5V \pm 2.5\%$ to guarantee the error comparator trip point.

TYPICAL APPLICATION CIRCUIT

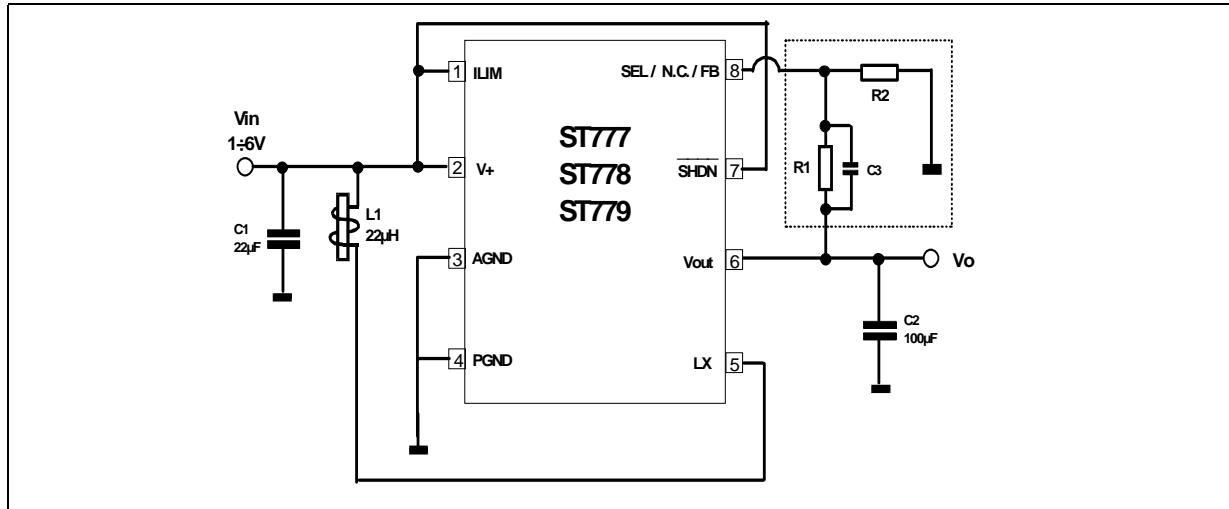

APPLICATIONS INFORMATION

R1 and R2 must be placed only in ST779 applications to set the output voltage according to the following equation:

$$V_{OUT} = (1.23) [(R1+R2)/R2]$$

and to simplify the resistor selection:

$$R1 = R2 [(V_{OUT}/1.23)-1]$$

It is possible to use a wide range of values for R2 (10KΩ to 50KΩ) with no significant loss of accuracy thanks to the very low FB input current. To have 1% error, the current through R2 must be at least 100 times FB's bias current.

When large values are used for the feedback resistors (R1>50KΩ), stray output impedance at FB can incidentally add "lag" to the feedback response, destabilizing the regulator and creating a larger ripple at the output. Lead lengths and circuit board traces at the FB node should be kept short. Compensate the loop by adding a "lead" compensation capacitor (C3, 100pF to 1nF) in parallel with R1.

The typical value of the L1 inductor is 22µH, enough for most applications. However, are also suitable values ranging from 10µF to 47µF with a saturation rating equal to or greater than the peak switch -current limit.

Efficiency will be reduced if the inductor works near its saturation limit, while will be maximized using an inductor with a low DC resistance, preferably under 0.2Ω.

Connecting ILIM to V_{IN} the maximum LX current limit (1A) is set. If this maximum value is not required is possible to reduce it connecting a resistor between ILIM and V_{IN} (See Figure 16 to choose the right value). The current limit value is misured when the switch current through the inductor begins to flatten and does'nt coincide with the max short circuit current.

Even if the device is designed to tolerate a short circuit without any damage, it is strictly recommended to avoid a continuous and durable short circuit of the output to GND.

To achieve the best performances from switching power supply topology, particular care to layout drawing is needed, in order to minimize EMI and obtain low noise. Moreover, jitter free operation ensures the full device functionality. Wire lengths must be minimized, filter and by-pass capacitors must be low ESR type, placed as close as possible to the integrated circuit. Solder AGND and PGND pins directly to a ground plane.

TYPICAL CHARACTERISTICS (unless otherwise specified $T_j = 25^\circ\text{C}$, $C_I=22\mu\text{F}$, $C_O=100\mu\text{F}$)

Figure 1 : Output Voltage vs Temperature

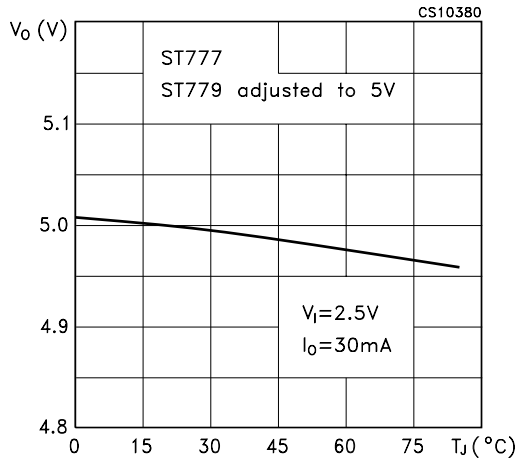

Figure 2 : Output Voltage vs Temperature

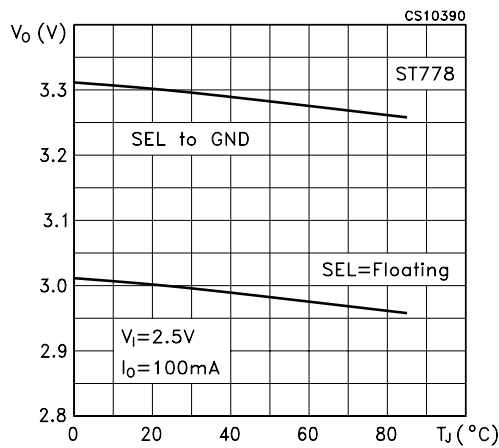

Figure 3 : Efficiency vs Temperature

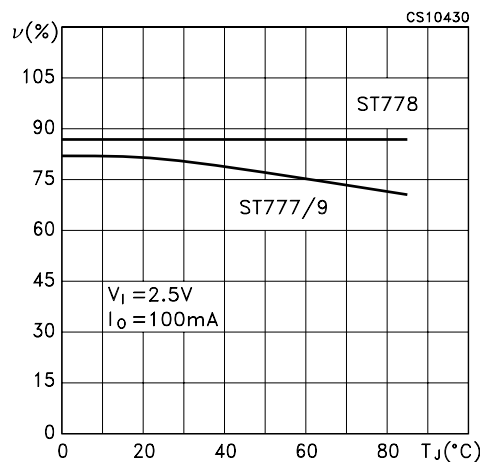

Figure 4 : Efficiency vs Input Voltage

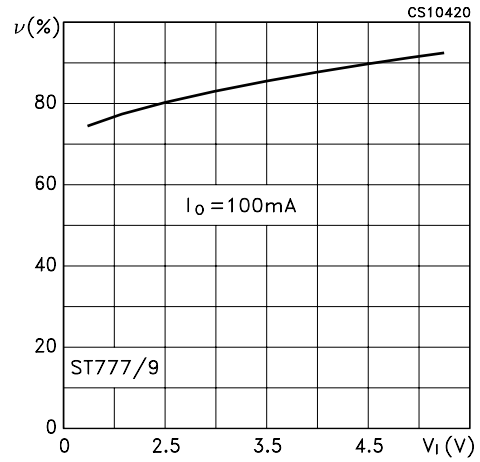

Figure 5 : Efficiency vs Output Current

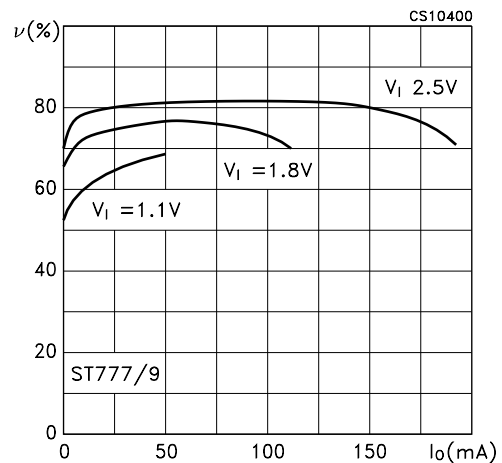

Figure 6 : Efficiency vs Low Output Current

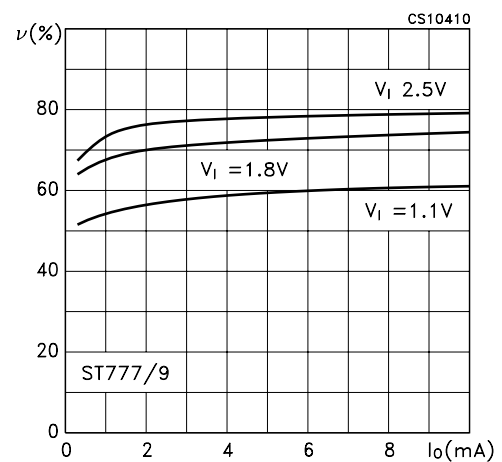

Figure 7 : No Load Supply Current vs Input Voltage

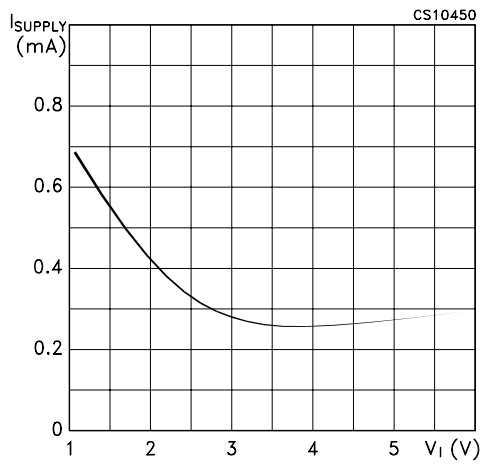

Figure 10 : Minimum Switch Off Time vs Temperature

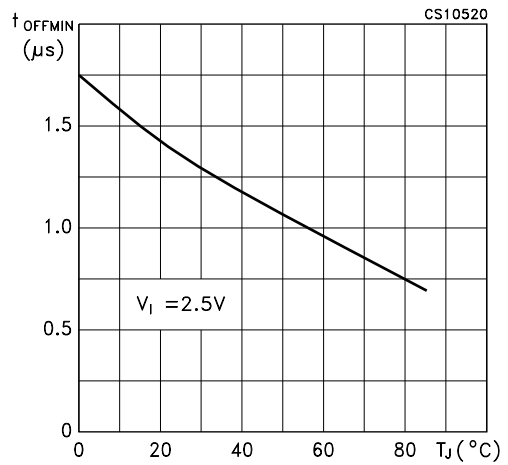

Figure 8 : No Load Supply Current vs Temperature

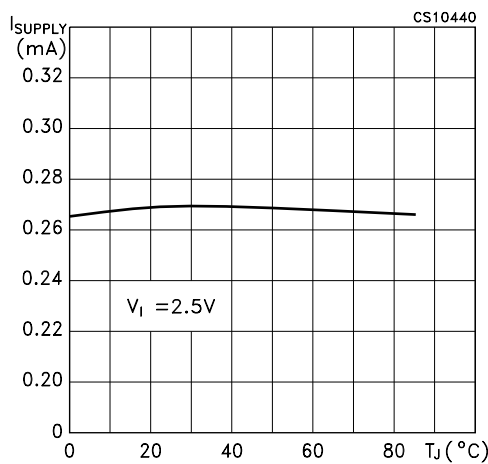

Figure 11 : Maximum Switch ON Time vs Temperature

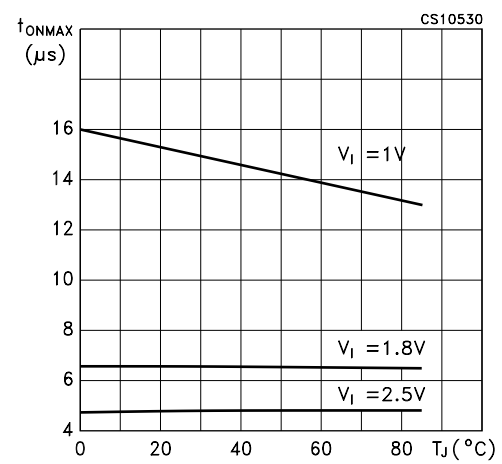

Figure 9 : Shutdown Input Threshold vs Input Voltage

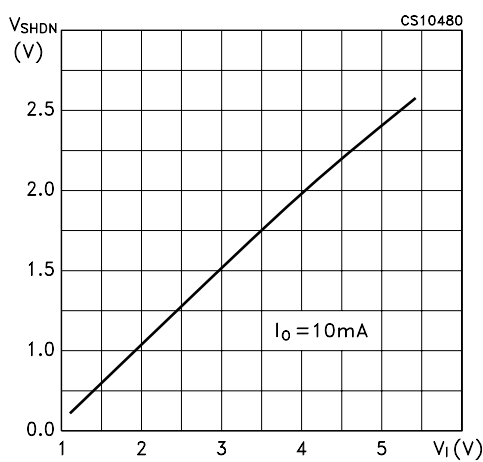

Figure 12 : FB Pin Bias Current vs Temperature

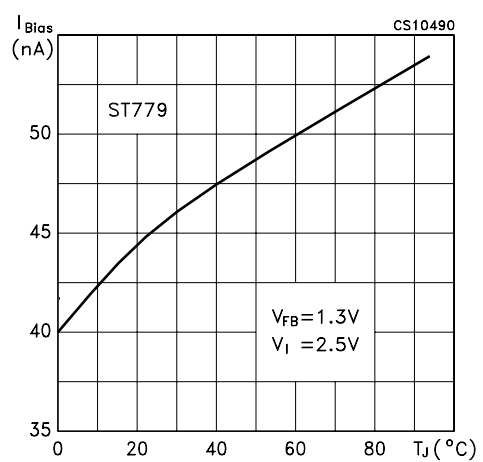

Figure 13 : Error Comparator Trip Point vs Temperature

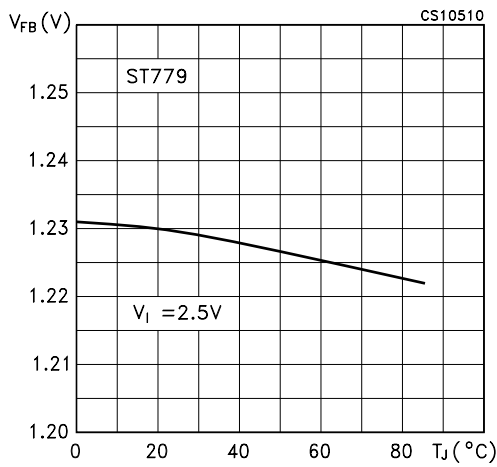

Figure 15 : Maximum Output Current vs Input Voltage

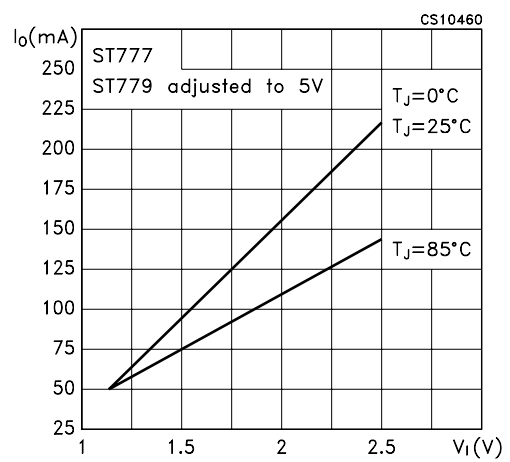

Figure 14 : Maximum Output Current vs Input Voltage

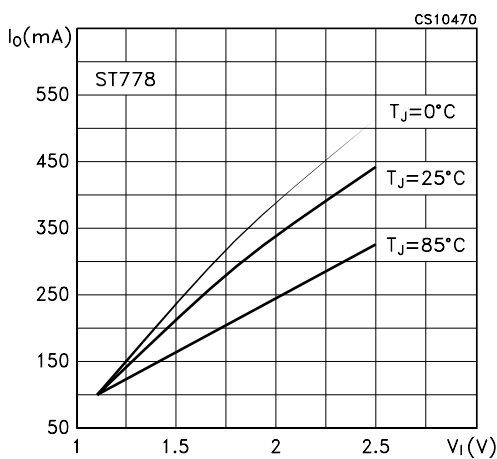

Figure 16 : Peak Inductor Current vs Current-Limit Resistor

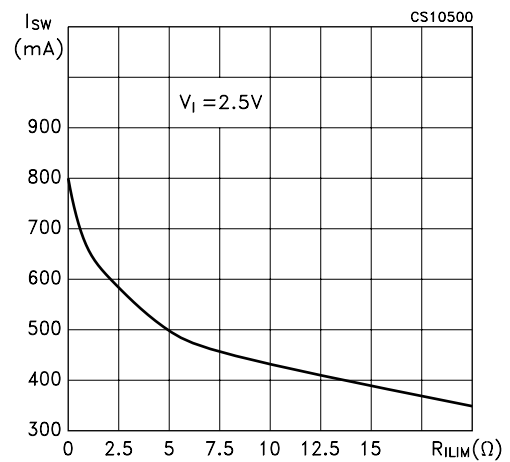

Figure 17 : Line Transient

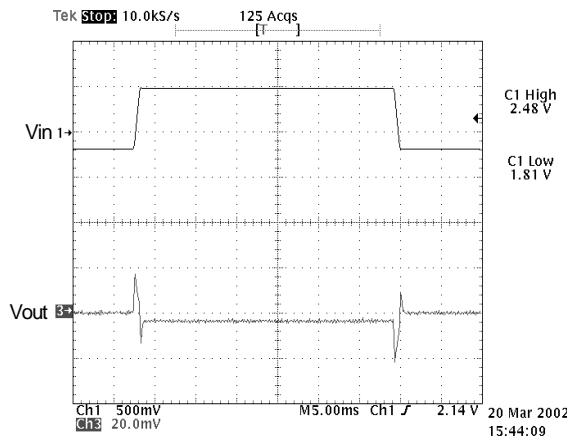

Figure 19 : Switching Waveform

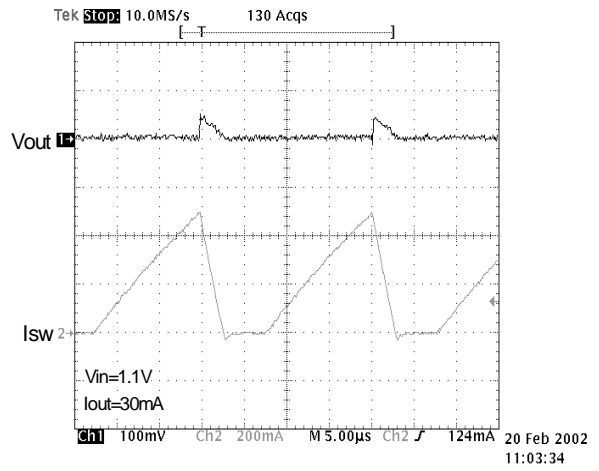

Figure 18 : Load Transient

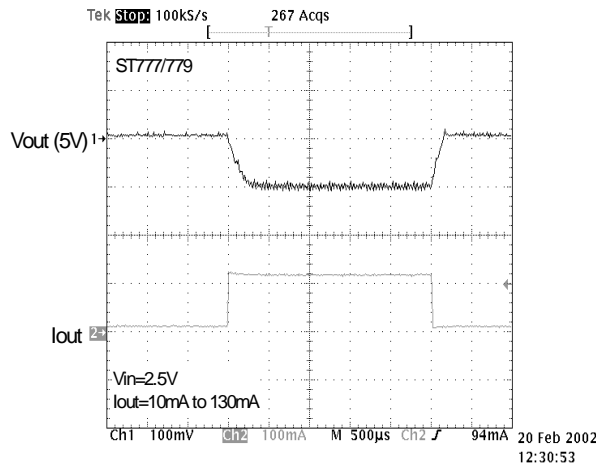
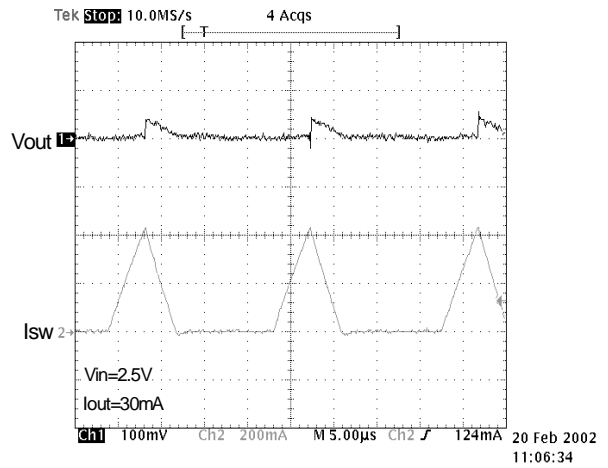
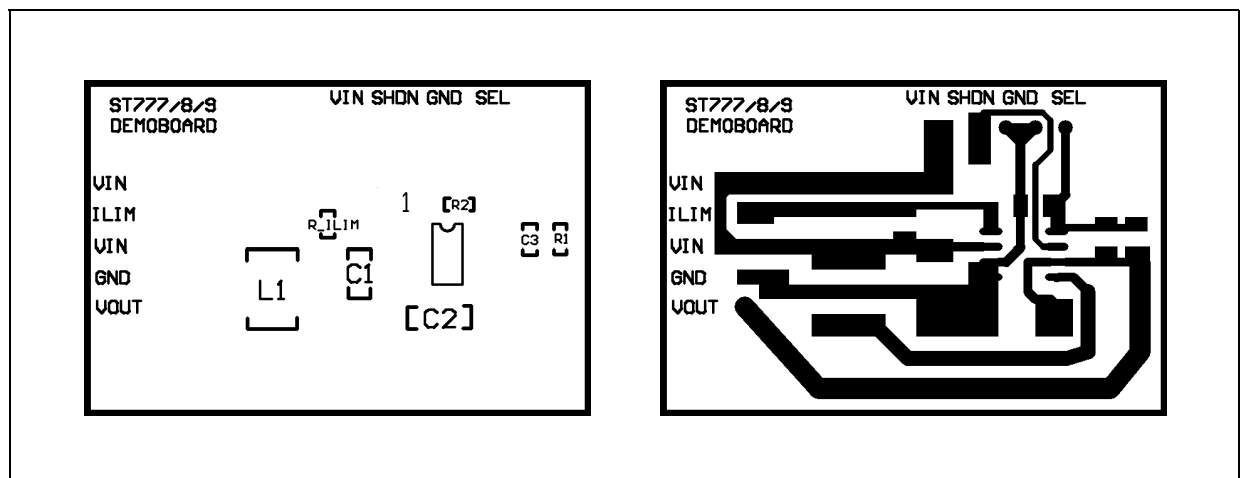

Figure 20 : Switching Waveform



PRINTED DEMOBOARD (Not in scale)



Plastic DIP-8 MECHANICAL DATA

DIM.	mm.			inch		
	MIN.	TYP.	MAX.	MIN.	TYP.	MAX.
A		3.3			0.130	
a1	0.7			0.028		
B	1.39		1.65	0.055		0.065
B1	0.91		1.04	0.036		0.041
b		0.5			0.020	
b1	0.38		0.5	0.015		0.020
D			9.8			0.386
E		8.8			0.346	
e		2.54			0.100	
e3		7.62			0.300	
e4		7.62			0.300	
F			7.1			0.280
I			4.8			0.189
L		3.3			0.130	
Z	0.44		1.6	0.017		0.063

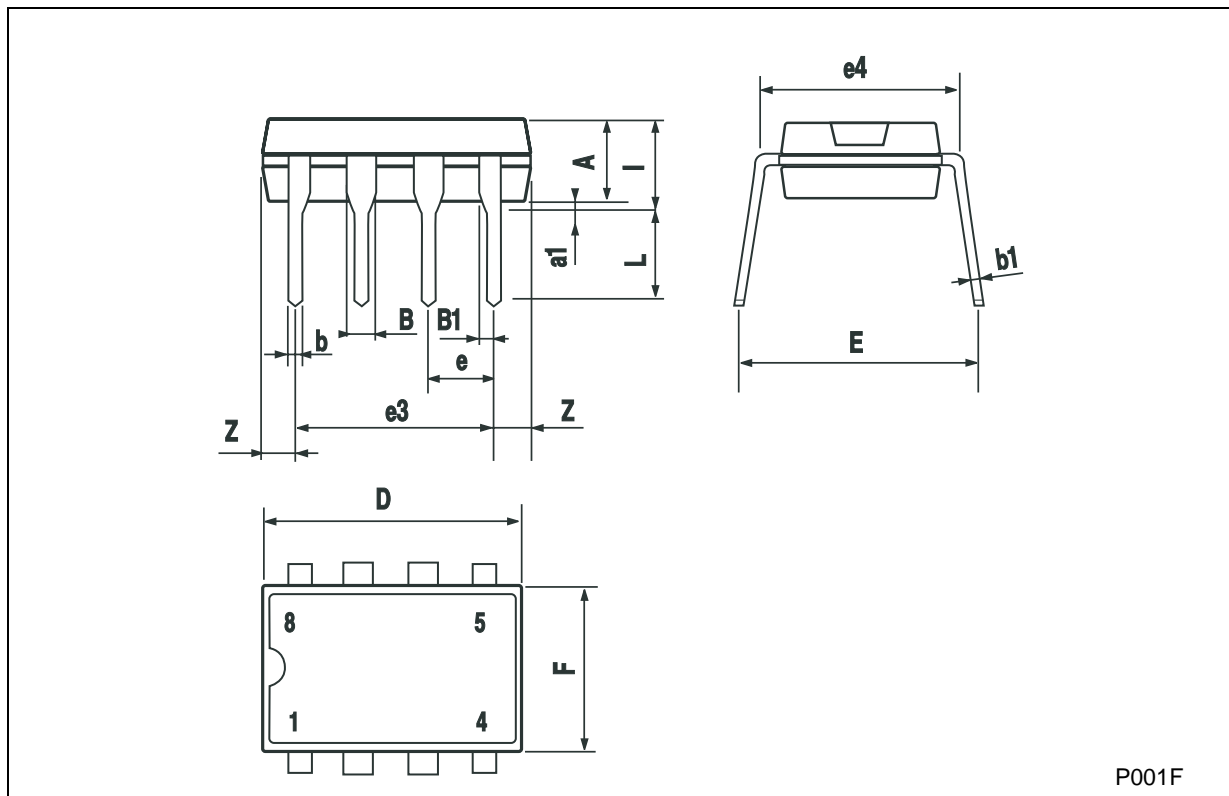

P001F

SO-8 MECHANICAL DATA

DIM.	mm.			inch		
	MIN.	TYP.	MAX.	MIN.	TYP.	MAX.
A			1.75			0.068
a1	0.1		0.25	0.003		0.009
a2			1.65			0.064
a3	0.65		0.85	0.025		0.033
b	0.35		0.48	0.013		0.018
b1	0.19		0.25	0.007		0.010
C	0.25		0.5	0.010		0.019
c1	45° (typ.)					
D	4.8		5.0	0.189		0.196
E	5.8		6.2	0.228		0.244
e		1.27			0.050	
e3		3.81			0.150	
F	3.8		4.0	0.149		0.157
L	0.4		1.27	0.015		0.050
M			0.6			0.023
S	8° (max.)					

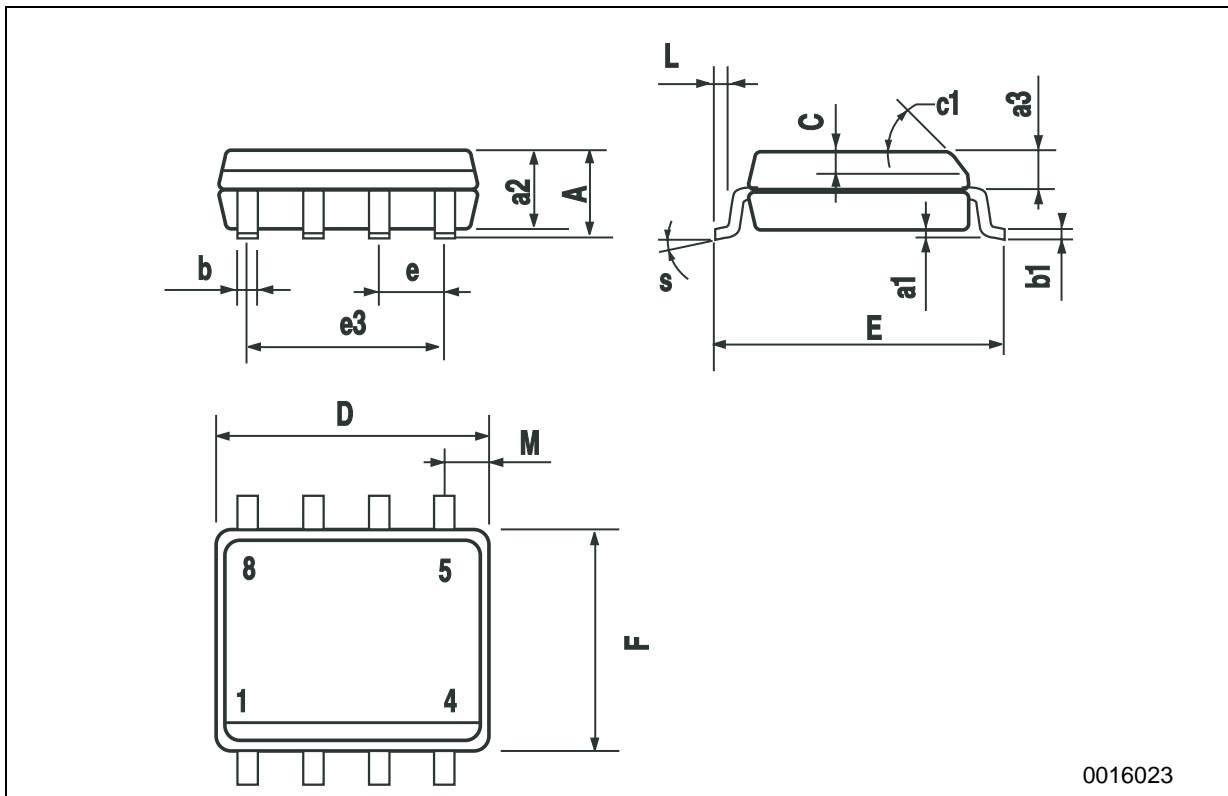

0016023

Information furnished is believed to be accurate and reliable. However, STMicroelectronics assumes no responsibility for the consequences of use of such information nor for any infringement of patents or other rights of third parties which may result from its use. No license is granted by implication or otherwise under any patent or patent rights of STMicroelectronics. Specifications mentioned in this publication are subject to change without notice. This publication supersedes and replaces all information previously supplied. STMicroelectronics products are not authorized for use as critical components in life support devices or systems without express written approval of STMicroelectronics.

© The ST logo is a registered trademark of STMicroelectronics

© 2002 STMicroelectronics - Printed in Italy - All Rights Reserved
STMicroelectronics GROUP OF COMPANIES

Australia - Brazil - Canada - China - Finland - France - Germany - Hong Kong - India - Israel - Italy - Japan - Malaysia - Malta - Morocco
Singapore - Spain - Sweden - Switzerland - United Kingdom - United States.

© <http://www.st.com>

