

MM74HCT05 Hex Inverter (Open Drain)

General Description

The MM74HCT05 is a logic function fabricated by using advanced silicon-gate CMOS technology, which provides the inherent benefits of CMOS—low quiescent power and wide power supply range. The device is also input and output characteristic and pinout compatible with standard DM74LS logic families. The MM74HCT05 open drain Hex Inverter requires the addition of an external resistor to perform a wire-NOR function.

All inputs are protected from static discharge damage by internal diodes to V_{CC} and ground.

MM74HCT devices are intended to interface between TTL and NMOS components and standard CMOS devices. These parts are also plug-in replacements for LS-TTL devices and can be used to reduce power consumption in existing designs.

Features

- Open drain for wire-NOR function
- LS-TTL pinout and threshold compatible
- Fanout of 10 LS-TTL loads
- Typical propagation delays:
 t_{PZL} (with 1 k Ω resistor) 10 ns
 t_{PLZ} (with 1 k Ω resistor) 8 ns

Ordering Code:

Order Number	Package Number	Package Description
MM74HCT05M	M14A	14-Lead Small Outline Integrated Circuit (SOIC), JEDEC MS-012, 0.150" Narrow
MM74HCT05SJ	M14D	14-Lead Small Outline Package (SOP), EIAJ TYPE II, 5.3mm Wide
MM74HCT05MTC	MTC14	14-Lead Thin Shrink Small Outline Package (TSSOP), JEDEC MO-153, 4.4mm Wide
MM74HCT05N	N14A	14-Lead Plastic Dual-In-Line Package (PDIP), JEDEC MS-001, 0.300" Wide

Devices also available in Tape and Reel. Specify by appending the suffix letter "X" to the ordering code.

Connection Diagram

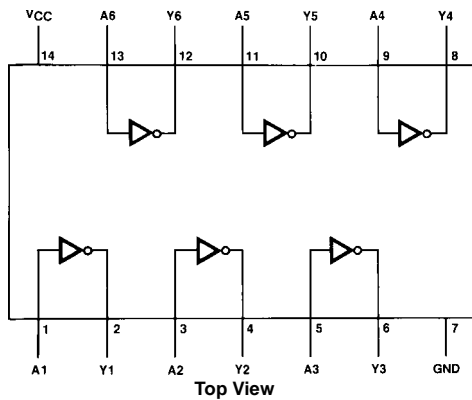

Logic Diagram

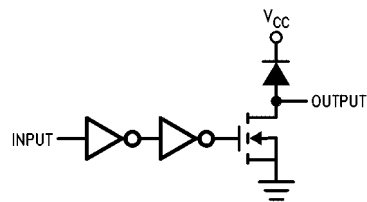

Typical Application

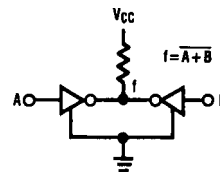

Absolute Maximum Ratings (Note 1)

(Note 2)

Supply Voltage (V_{CC})	-0.5 to +7.0V
DC Input Voltage (V_{IN})	-1.5 to $V_{CC} + 1.5V$
DC Output Voltage (V_{OUT})	-0.5 to +7.0V
Clamp Diode Current (I_{IK}, I_{OK})	± 20 mA
DC Output Current, per pin (I_{OUT})	+ 25 mA
DC V_{CC} or GND Current, per pin (I_{CC})	± 50 mA
Storage Temperature Range (T_{STG})	-65°C to +150°C
Power Dissipation (P_D)	
(Note 3)	600 mW
S.O. Package only	500 mW
Lead Temperature (T_L)	
(Soldering 10 seconds)	260°C

Recommended Operating Conditions

	Min	Max	Units
Supply Voltage (V_{CC})	4.5	5.5	V
DC Input Voltage (V_{IN})	0	V_{CC}	V
Output Voltage (V_{OUT})	0	5.5	V
Operating Temperature Range (T_A)	-40	+85	°C
Input Rise or Fall Times (t_r, t_f)		500	ns

Note 1: Absolute Maximum Ratings are those values beyond which damage to the device may occur.**Note 2:** Unless otherwise specified all voltages are referenced to ground.**Note 3:** Power Dissipation temperature derating — plastic "N" package: -12 mW/°C from 65°C to 85°C.**DC Electrical Characteristics** $(V_{CC} = 5V \pm 10\%, \text{ unless otherwise specified})$

Symbol	Parameter	Conditions	$T_A = 25^\circ\text{C}$		$T_A = -40$ to 85°C	Units
			Typ	Guaranteed Limits		
V_{IH}	Minimum HIGH Level Input Voltage			2.0	2.0	V
V_{IL}	Maximum LOW Level Input Voltage			0.8	0.8	V
V_{OL}	Maximum LOW Level Voltage	$V_{IN} = V_{IH}$ $ I_{OUT} = 20 \mu\text{A}$ $ I_{OUT} = 4.0 \text{ mA}, V_{CC} = 4.5V$ $ I_{OUT} = 4.8 \text{ mA}, V_{CC} = 5.5V$	0 0.2 0.2	0.1 0.26 0.26	0.1 0.33 0.33	V
I_{IN}	Maximum Input Current	$V_{IN} = V_{CC}$ or GND, V_{IH} or V_{IL}		± 0.1	± 1.0	μA
I_{LKG}	Maximum HIGH Level Output Leakage Current	$V_{IN} = V_{IH}$ or V_{IL} , $V_{OUT} = V_{CC}$		0.5	5.0	μA
I_{CC}	Maximum Quiescent Supply Current	$V_{IN} = V_{CC}$ or GND $I_{OUT} = 0 \mu\text{A}$ $V_{IN} = 2.4V$ or $0.5V$ (Note 4)		2.0 0.3	20 0.4	μA mA
I_{OHZ}	Off State Current	$V_{CC} = 4.5 - 5.5, V_O = 5.5$			10	μA

Note 4: This is measured per input with all other inputs held at V_{CC} or ground.

AC Electrical Characteristics

$V_{CC} = 5V$, $T_A = 25^\circ C$, $C_L = 15 \text{ pF}$, $t_r = t_f = 6 \text{ ns}$ unless otherwise noted.

Symbol	Parameter	Conditions	Typ	Guaranteed Limit	Units
t_{PZL}	Maximum Propagation Delay	$R_L = 1 \text{ k}\Omega$	8	15	ns
t_{PLZ}	Maximum Propagation Delay	$R_L = 1 \text{ k}\Omega$	9	16	ns

AC Electrical Characteristics

$V_{CC} = 5V, \pm 10\%$, $C_L = 50 \text{ pF}$, $t_r = t_f = 6 \text{ ns}$ unless otherwise specified.

Symbol	Parameter	Conditions	$T_A = 25^\circ C$		$T_A = -40 \text{ to } 85^\circ C$	Units
			Typ	Guaranteed Limits		
t_{PZL}	Maximum Propagation Delay	$R_L = 1 \text{ k}\Omega$	10	22	28	ns
t_{PLZ}	Maximum Propagation Delay	$R_L = 1 \text{ k}\Omega$	12	20	25	ns
t_{THL}	Maximum Output Fall Time		10	15	19	ns
C_{PD}	Power Dissipation Capacitance (Note 5)	(per gate) $R_L = \infty$		20		pF
C_{IN}	Maximum Input Capacitance			5	10	pF

Note 5: C_{PD} determines the no load dynamic power consumption, $P_D = C_{PD} V_{CC}^2 f + I_{CC} V_{CC}$, and the no load dynamic current consumption, $I_S = C_{PD} V_{CC} f + I_{CC}$.

Physical Dimensions inches (millimeters) unless otherwise noted

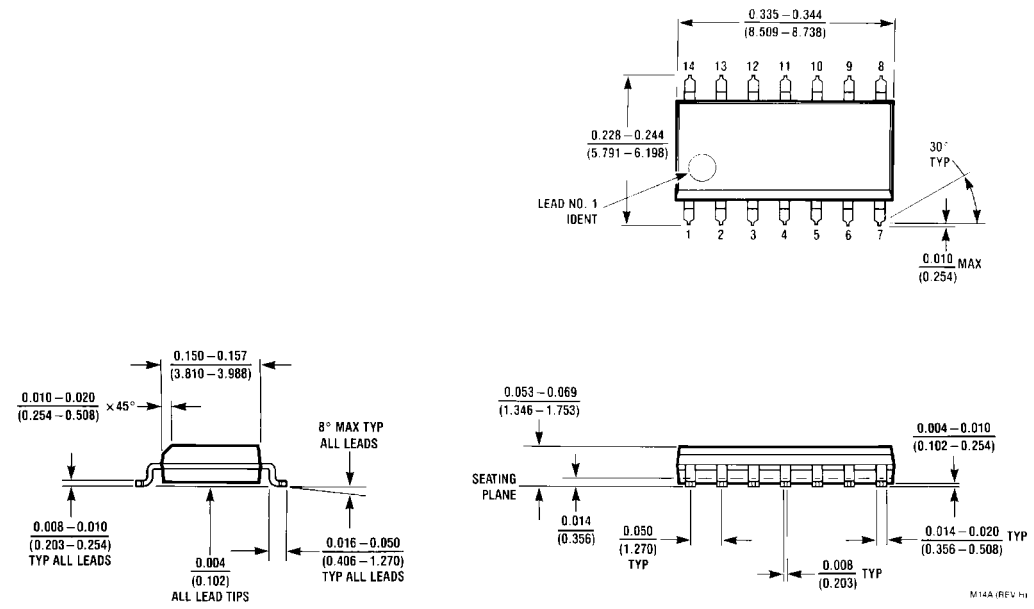

14-Lead Small Outline Integrated Circuit (SOIC), JEDEC MS-012, 0.150" Narrow Package Number M14A

Physical Dimensions inches (millimeters) unless otherwise noted (Continued)

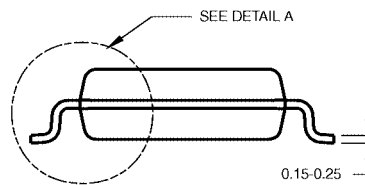
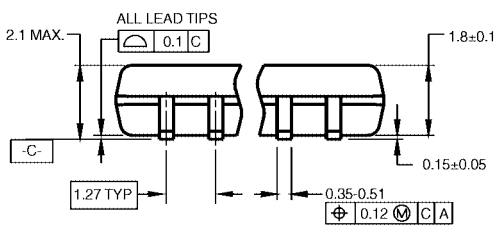
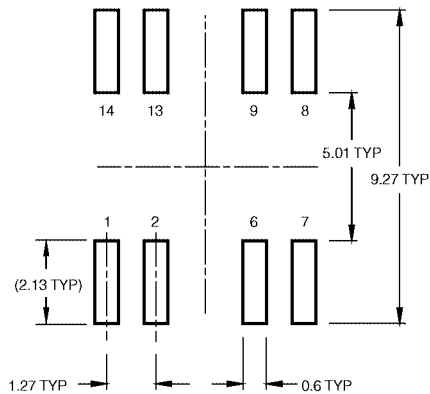
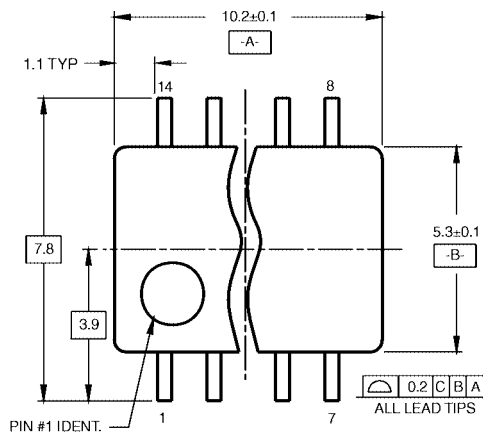

DIMENSIONS ARE IN MILLIMETERS

- NOTES:
 A. CONFORMS TO EIAJ EDR-7320 REGISTRATION, ESTABLISHED IN DECEMBER, 1998.
 B. DIMENSIONS ARE IN MILLIMETERS.
 C. DIMENSIONS ARE EXCLUSIVE OF BURRS, MOLD FLASH, AND TIE BAR EXTRUSIONS.

M14DRevB1



**14-Lead Small Outline Package (SOP), EIAJ TYPE II, 5.3mm Wide
 Package Number M14D**

Physical Dimensions inches (millimeters) unless otherwise noted (Continued)



LAND PATTERN RECOMMENDATION

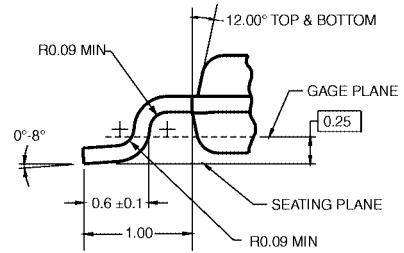
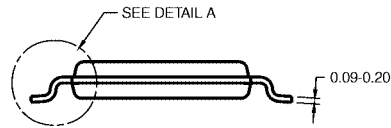
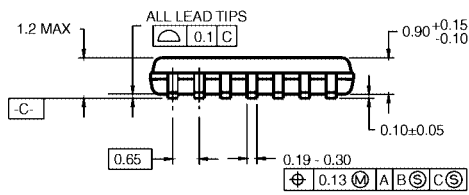

DETAIL A

- NOTES:
 A. CONFORMS TO JEDEC REGISTRATION MO-153, VARIATION AB, REF NOTE 6, DATE 7/93.
 B. DIMENSIONS ARE IN MILLIMETERS.
 C. DIMENSIONS ARE EXCLUSIVE OF BURRS, MOLD FLASH, AND TIE BAR EXTRUSIONS.
 D. DIMENSIONS AND TOLERANCES PER ANSI Y14.5M, 1982.

MTC14RevC3

14-Lead Thin Shrink Small Outline Package (TSSOP), JEDEC MO-153, 4.4mm Wide Package Number MTC14

Physical Dimensions inches (millimeters) unless otherwise noted (Continued)

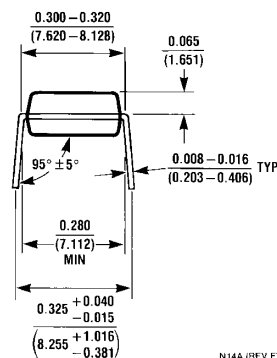
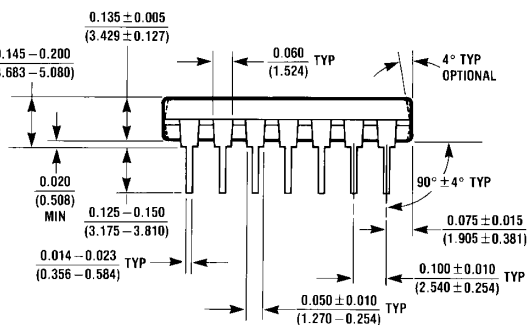
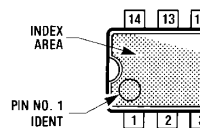
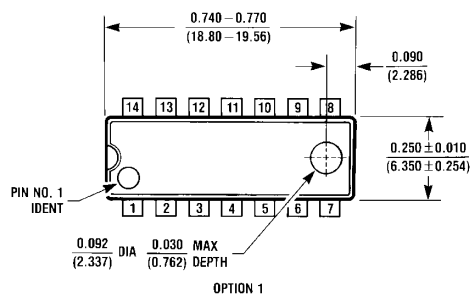

N14A (REV F)

14-Lead Plastic Dual-In-Line Package (PDIP), JEDEC MS-001, 0.300" Wide Package Number N14A

Fairchild does not assume any responsibility for use of any circuitry described, no circuit patent licenses are implied and Fairchild reserves the right at any time without notice to change said circuitry and specifications.

LIFE SUPPORT POLICY

FAIRCHILD'S PRODUCTS ARE NOT AUTHORIZED FOR USE AS CRITICAL COMPONENTS IN LIFE SUPPORT DEVICES OR SYSTEMS WITHOUT THE EXPRESS WRITTEN APPROVAL OF THE PRESIDENT OF FAIRCHILD SEMICONDUCTOR CORPORATION. As used herein:

1. Life support devices or systems are devices or systems which, (a) are intended for surgical implant into the body, or (b) support or sustain life, and (c) whose failure to perform when properly used in accordance with instructions for use provided in the labeling, can be reasonably expected to result in a significant injury to the user.
2. A critical component in any component of a life support device or system whose failure to perform can be reasonably expected to cause the failure of the life support device or system, or to affect its safety or effectiveness.

www.fairchildsemi.com