

MM74HC4066 Quad Analog Switch

General Description

The MM74HC4066 devices are digitally controlled analog switches utilizing advanced silicon-gate CMOS technology. These switches have low "ON" resistance and low "OFF" leakages. They are bidirectional switches, thus any analog input may be used as an output and visa-versa. Also the MM74HC4066 switches contain linearization circuitry which lowers the "ON" resistance and increases switch linearity. The MM74HC4066 devices allow control of up to 12V (peak) analog signals with digital control signals of the same range. Each switch has its own control input which disables each switch when LOW. All analog inputs and outputs and digital inputs are protected from electrostatic damage by diodes to V_{CC} and ground.

Features

- Typical switch enable time: 15 ns
- Wide analog input voltage range: 0–12V
- Low "ON" resistance: 30 typ. (MM74HC4066)
- Low quiescent current: 80 μ A maximum (74HC)
- Matched switch characteristics
- Individual switch controls

Ordering Code:

Order Number	Package Number	Package Description
MM74HC4066M	M14A	14-Lead Small Outline Integrated Circuit (SOIC), JEDEC MS-012, 0.150" Narrow
MM74HC4066MX_NL	M14A	Pb-Free 14-Lead Small Outline Integrated Circuit (SOIC), JEDEC MS-012, 0.150" Narrow
MM74HC4066SJ	M14D	Pb-Free 14-Lead Small Outline Package (SOP), EIAJ TYPE II, 5.3mm Wide
MM74HC4066MTC	MTC14	14-Lead Thin Shrink Small Outline Package (TSSOP), JEDEC MO-153, 4.4mm Wide
MM74HC4066N	N14A	14-Lead Plastic Dual-In-Line Package (PDIP), JEDEC MS-001, 0.300" Wide

Devices also available in Tape and Reel. Specify by appending the suffix letter "X" to the ordering code.
Pb-Free package per JEDEC J-STD-020B.

Schematic Diagram

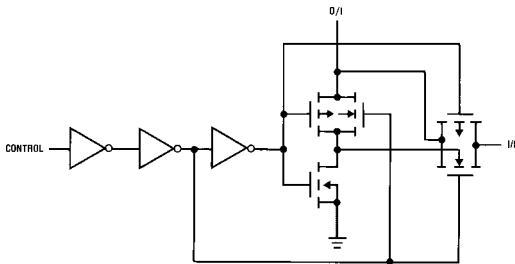

Connection Diagram

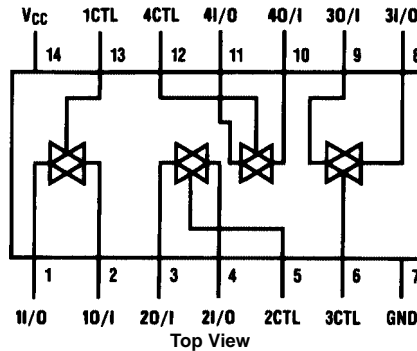

Truth Table

Input	Switch
CTL	I/O–O/I
L	"OFF"
H	"ON"

Absolute Maximum Ratings (Note 1)

(Note 2)

Supply Voltage (V_{CC})	-0.5 to +15V
DC Control Input Voltage (V_{IN})	-1.5 to V_{CC} +1.5V
DC Switch I/O Voltage (V_{IO})	V_{EE} -0.5 to V_{CC} +0.5V
Clamp Diode Current (I_{IK}, I_{OK})	± 20 mA
DC Output Current, per pin (I_{OUT})	± 25 mA
DC V_{CC} or GND Current, per pin (I_{CC})	± 50 mA
Storage Temperature Range (T_{STG})	-65°C to +150°C
Power Dissipation (P_D)	
(Note 3)	600 mW
S.O. Package only	500 mW
Lead Temperature (T_L)	
(Soldering 10 seconds)	260°C

Recommended Operating Conditions

	Min	Max	Units
Supply Voltage (V_{CC})	2	12	V
DC Input or Output Voltage (V_{IN}, V_{OUT})	0	V_{CC}	V
Operating Temperature Range (T_A)	-40	+85	°C
Input Rise or Fall Times (t_r, t_f)			
$V_{CC} = 2.0V$		1000	ns
$V_{CC} = 4.5V$		500	ns
$V_{CC} = 9.0V$		400	ns

Note 1: Absolute Maximum Ratings are those values beyond which damage to the device may occur.

Note 2: Unless otherwise specified all voltages are referenced to ground.

Note 3: Power Dissipation temperature derating — plastic "N" package: -12 mW/°C from 65°C to 85°C.

DC Electrical Characteristics (Note 4)

Symbol	Parameter	Conditions	V_{CC}	$T_A = 25^\circ\text{C}$		$T_A = -40$ to 85°C	$T_A = -55$ to 125°C	Units
				Typ	Guaranteed Limits			
V_{IH}	Minimum HIGH Level Input Voltage		2.0V		1.5	1.5	1.5	V
			4.5V		3.15	3.15	3.15	V
			9.0V		6.3	5.3	6.3	V
			12.0V		8.4	8.4	8.4	V
V_{IL}	Maximum LOW Level Input Voltage		2.0V		0.5	0.5	0.5	V
			4.5V		1.35	1.35	1.35	V
			9.0V		2.7	2.7	2.7	V
			12.0V		3.6	3.6	3.6	V
R_{ON}	Maximum "ON" Resistance (Note 5)	$V_{CTL} = V_{IH}, I_S = 2.0$ mA $V_{IS} = V_{CC}$ to GND (Figure 1)	4.5V	100	170	200	220	Ω
			9.0V	50	85	105	110	Ω
			12.0V	30	70	85	90	Ω
			2.0V	120	180	215	240	Ω
		$V_{CTL} = V_{IH}, I_S = 2.0$ mA $V_{IS} = V_{CC}$ or GND (Figure 1)	4.5V	50	80	100	120	Ω
			9.0V	35	60	75	80	Ω
			12.0V	20	40	60	70	Ω
			R_{ON}	Maximum "ON" Resistance Matching	$V_{CTL} = V_{IH}$ $V_{IS} = V_{CC}$ to GND	4.5V	10	15
9.0V	5	10				15	15	Ω
12.0V	5	10				15	15	Ω
I_{IN}	Maximum Control Input Current	$V_{IN} = V_{CC}$ or GND $V_{CC} = 2-6V$			± 0.1	± 1.0	± 1.0	μA
I_{IZ}	Maximum Switch "OFF" Leakage Current	$V_{OS} = V_{CC}$ or GND $V_{IS} = \text{GND}$ or V_{CC} $V_{CTL} = V_{IL}$ (Figure 3)	6.0V	10	± 60	± 600	± 600	nA
			9.0V	15	± 80	± 800	± 800	nA
			12.0V	20	± 100	± 1000	± 1000	nA
I_{IZ}	Maximum Switch "ON" Leakage Current	$V_{IS} = V_{CC}$ to GND $V_{CTL} = V_{IH}$ $V_{OS} = \text{OPEN}$ (Figure 2)	6.0V	10	± 40	± 150	± 150	nA
			9.0V	15	± 50	± 200	± 200	nA
			12.0V	20	± 60	± 300	± 300	nA
I_{CC}	Maximum Quiescent Supply Current	$V_{IN} = V_{CC}$ or GND $I_{OUT} = 0$ μA	6.0V		2.0	20	40	μA
			9.0V		4.0	40	80	μA
			12.0V		8.0	80	160	μA

Note 4: For a power supply of 5V $\pm 10\%$ the worst case on resistance (R_{ON}) occurs for HC at 4.5V. Thus the 4.5V values should be used when designing with this supply. Worst case V_{IH} and V_{IL} occur at $V_{CC} = 5.5V$ and 4.5V respectively. (The V_{IH} value at 5.5V is 3.85V.) The worst case leakage current occurs for CMOS at the higher voltage and so the 5.5V values should be used.

Note 5: At supply voltages (V_{CC} -GND) approaching 2V the analog switch on resistance becomes extremely non-linear. Therefore it is recommended that these devices be used to transmit digital only when using these supply voltages.

AC Electrical Characteristics								
$V_{CC} = 2.0V-6.0V$ $V_{EE} = 0V-12V$, $C_L = 50$ pF (unless otherwise specified)								
Symbol	Parameter	Conditions	V_{CC}	$T_A = 25^\circ C$		$T_A = -40$ to $85^\circ C$	$T_A = -55$ to $125^\circ C$	Units
				Typ	Guaranteed Limits			
t_{PHL} , t_{PLH}	Maximum Propagation Delay Switch In to Out		2.0V	25	50	30	75	ns
			4.5V	5	10	13	15	ns
			9.0V	4	8	10	12	ns
			12.0V	3	7	11	13	ns
t_{PZL} , t_{PZH}	Maximum Switch Turn "ON" Delay	$R_L = 1$ k Ω	2.0V	30	100	125	150	ns
			4.5V	12	20	25	30	ns
			9.0V	6	12	15	18	ns
			12.0V	5	10	13	15	ns
t_{PHZ} , t_{PLZ}	Maximum Switch Turn "OFF" Delay	$R_L = 1$ k Ω	2.0V	60	168	210	252	ns
			4.5V	25	36	45	54	ns
			9.0V	20	32	40	48	ns
			12.0V	15	30	38	45	ns
f_{MAX}	Minimum Frequency Response (Figure 7)	$R_L = 600\Omega$ $V_{IS} = 2 V_{PP}$ at $(V_{CC}/2)$ (Note 6) (Note 7)	4.5V	40				MHz
			9.0V	100				MHz
	Crosstalk Between any Two Switches (Figure 8)	$R_L = 600\Omega$, $F = 1$ MHz (Note 7) (Note 8)	4.5V	-52				dB
			9.0V	-50				dB
	Peak Control to Switch Feedthrough Noise (Figure 9)	$R_L = 600\Omega$, $F = 1$ MHz $C_L = 50$ pF	4.5V	100				mV
			9.0V	250				mV
	Switch OFF Signal Feedthrough Isolation (Figure 10)	$R_L = 600\Omega$, $F = 1$ MHz $V_{(CT)}V_{IL}$ (Note 7) (Note 8)	4.5V	-42				dB
			9.0V	-44				dB
THD	Total Harmonic Distortion (Figure 11)	$R_L = 10$ k Ω , $C_L = 50$ pF, $F = 1$ kHz $V_{IS} = 4 V_{PP}$ $V_{IS} = 8 V_{PP}$	4.5V	.013				%
			9.0V	.008				%
C_{IN}	Maximum Control Input Capacitance			5	10	10	10	pF
C_{IN}	Maximum Switch Input Capacitance			20				pF
C_{IN}	Maximum Feedthrough Capacitance	$V_{CTL} = GND$		0.5				pF
C_{PD}	Power Dissipation Capacitance			15				pF
<p>Note 6: Adjust 0 dBm for $F = 1$ kHz (Null R_L/R_{ON} Attenuation).</p> <p>Note 7: V_{IS} is centered at $V_{CC}/2$.</p> <p>Note 8: Adjust input for 0 dBm.</p>								

AC Test Circuits and Switching Time Waveforms

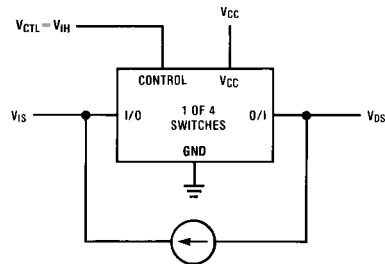

FIGURE 1. "ON" Resistance

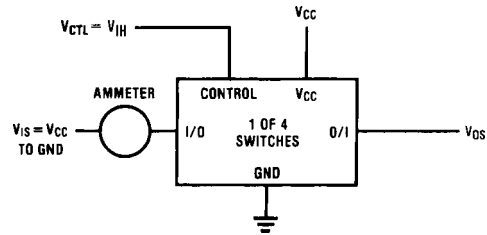

FIGURE 2. "ON" Channel Leakage Current

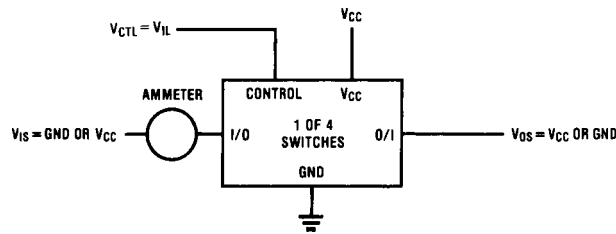

FIGURE 3. "OFF" Channel Leakage Current

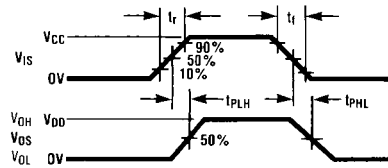
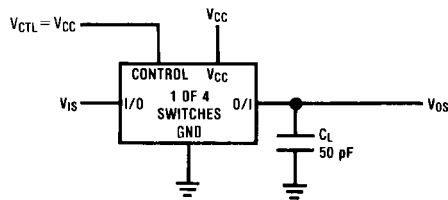

FIGURE 4. t_{PHL} , t_{PLH} Propagation Delay Time Signal Input to Signal Output

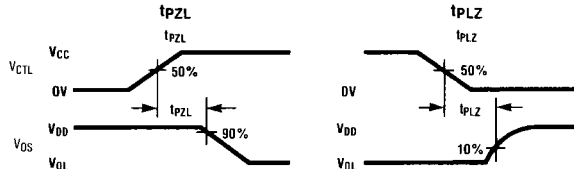
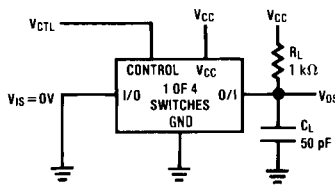

FIGURE 5. t_{PZL} , t_{PLZ} Propagation Delay Time Control to Signal Output

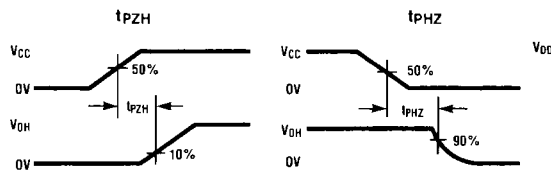
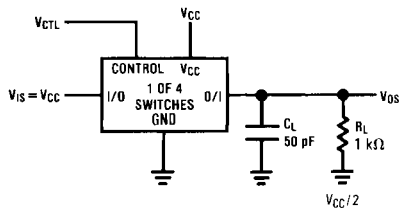

FIGURE 6. t_{PZH} , t_{PHZ} Propagation Delay Time Control to Signal Output

AC Test Circuits and Switching Time Waveforms (Continued)

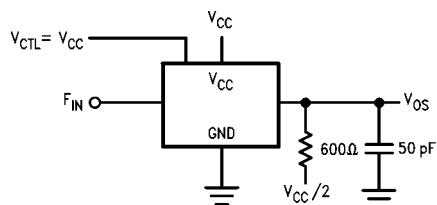

FIGURE 7. Frequency Response

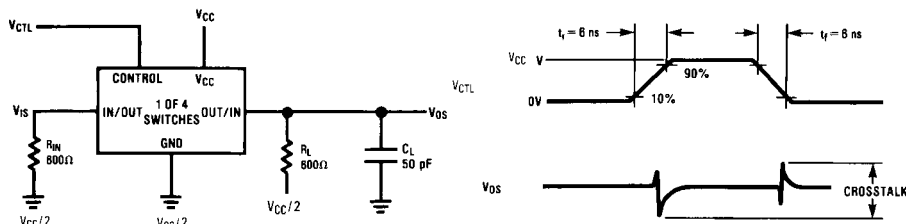

FIGURE 8. Crosstalk: Control Input to Signal Output

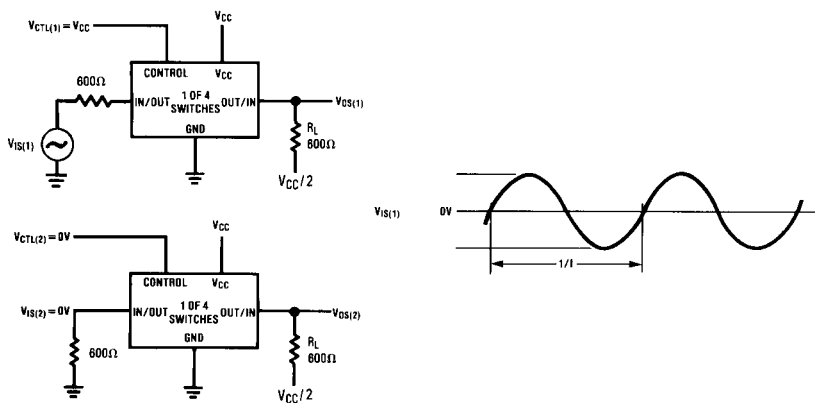

FIGURE 9. Crosstalk Between Any Two Switches

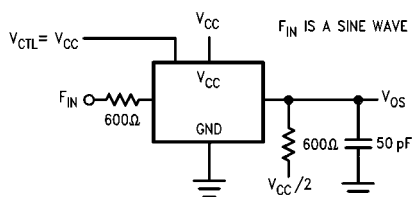

FIGURE 10. Switch OFF Signal Feedthrough Isolation

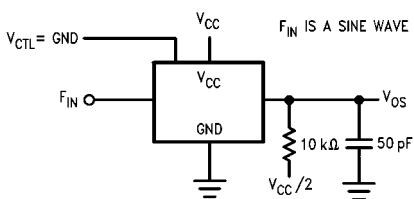
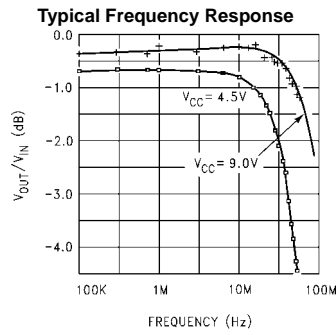
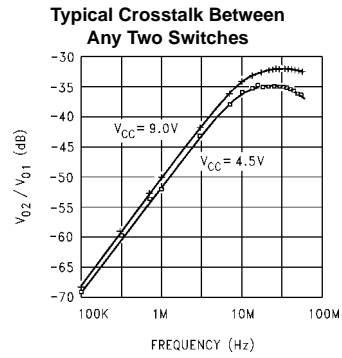
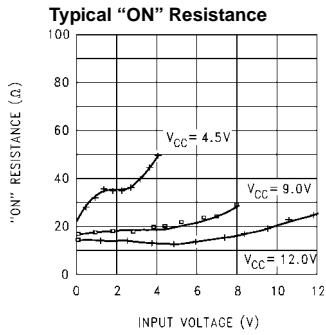

FIGURE 11. Sinewave Distortion

Typical Performance Characteristics



Special Considerations

In certain applications the external load-resistor current may include both V_{CC} and signal line components. To avoid drawing V_{CC} current when switch current flows into

the analog switch input pins, the voltage drop across the switch must not exceed 0.6V (calculated from the ON resistance).

Physical Dimensions inches (millimeters) unless otherwise noted



**14-Lead Small Outline Integrated Circuit (SOIC), JEDEC MS-012, 0.150" Narrow
Package Number M14A**

M14A (REV. H)

Physical Dimensions inches (millimeters) unless otherwise noted (Continued)

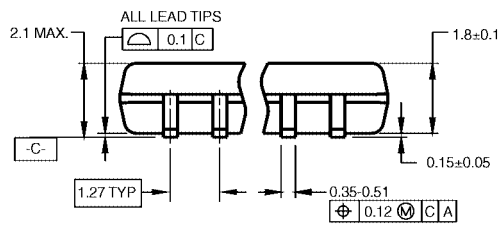
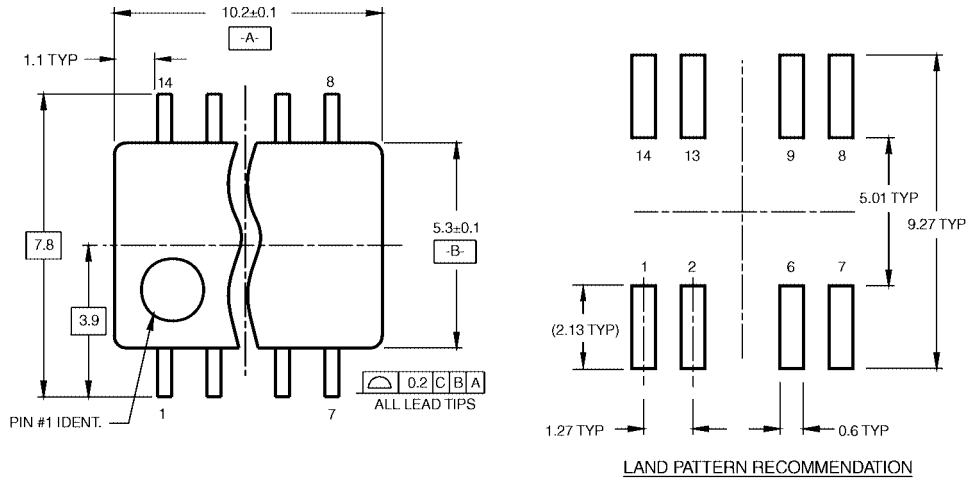

DIMENSIONS ARE IN MILLIMETERS

- NOTES:
 A. CONFORMS TO EIAJ EDR-7320 REGISTRATION, ESTABLISHED IN DECEMBER, 1998.
 B. DIMENSIONS ARE IN MILLIMETERS.
 C. DIMENSIONS ARE EXCLUSIVE OF BURRS, MOLD FLASH, AND TIE BAR EXTRUSIONS.

M14DRevB1



**Pb-Free 14-Lead Small Outline Package (SOP), EIAJ TYPE II, 5.3mm Wide
 Package Number M14D**

Physical Dimensions inches (millimeters) unless otherwise noted (Continued)

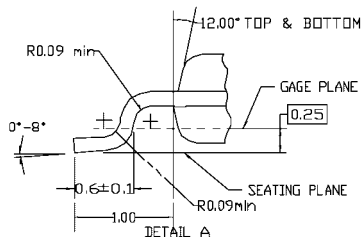
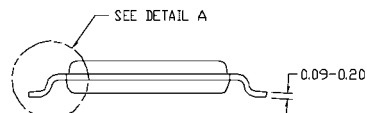
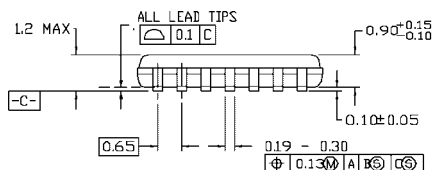
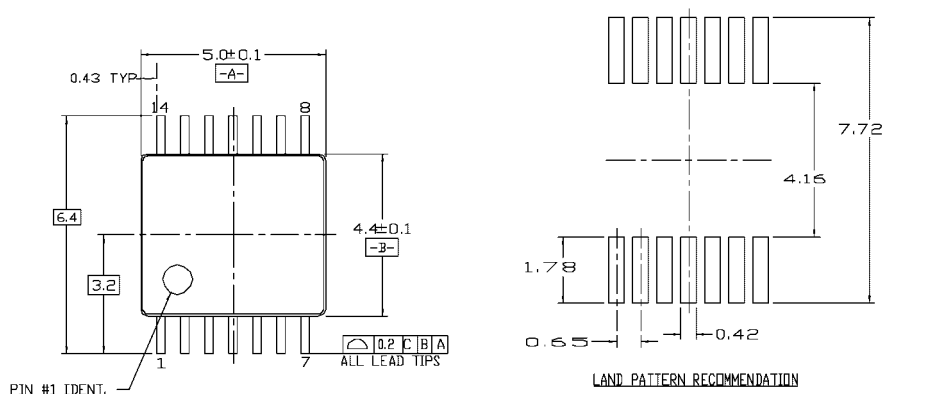

- NOTES:
- A. CONFORMS TO JEDEC REGISTRATION MO-153, VARIATION AB, REF NOTE 6, DATED 7/93
 - B. DIMENSIONS ARE IN MILLIMETERS
 - C. DIMENSIONS ARE EXCLUSIVE OF BURRS, MOLD FLASH, AND TIE BAR EXTRUSIONS
 - D. DIMENSIONING AND TOLERANCES PER ANSI Y14.5M, 1982

MTC14revD

14-Lead Thin Shrink Small Outline Package (TSSOP), JEDEC MO-153, 4.4mm Wide Package Number MTC14

Physical Dimensions inches (millimeters) unless otherwise noted (Continued)

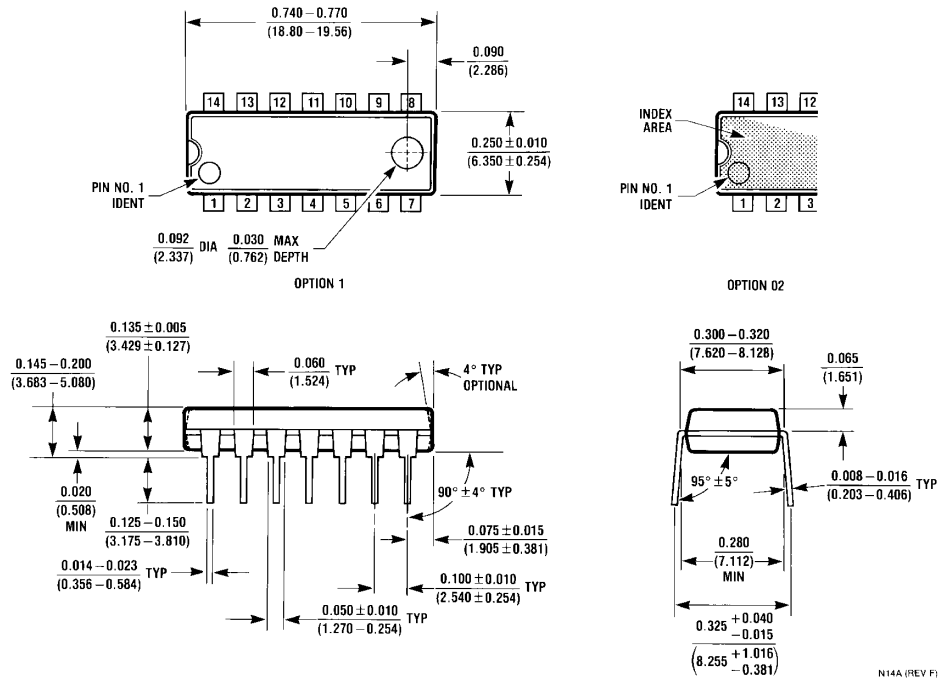

14-Lead Plastic Dual-In-Line Package (PDIP), JEDEC MS-001, 0.300" Wide Package Number N14A

Fairchild does not assume any responsibility for use of any circuitry described, no circuit patent licenses are implied and Fairchild reserves the right at any time without notice to change said circuitry and specifications.

LIFE SUPPORT POLICY

FAIRCHILD'S PRODUCTS ARE NOT AUTHORIZED FOR USE AS CRITICAL COMPONENTS IN LIFE SUPPORT DEVICES OR SYSTEMS WITHOUT THE EXPRESS WRITTEN APPROVAL OF THE PRESIDENT OF FAIRCHILD SEMICONDUCTOR CORPORATION. As used herein:

1. Life support devices or systems are devices or systems which, (a) are intended for surgical implant into the body, or (b) support or sustain life, and (c) whose failure to perform when properly used in accordance with instructions for use provided in the labeling, can be reasonably expected to result in a significant injury to the user.
2. A critical component in any component of a life support device or system whose failure to perform can be reasonably expected to cause the failure of the life support device or system, or to affect its safety or effectiveness.

www.fairchildsemi.com