

MM54HC4016/MM74HC4016 Quad Analog Switch

General Description

These devices are digitally controlled analog switches implemented in advanced silicon-gate CMOS technology. These switches have low "on" resistance and low "off" leakages. They are bidirectional switches, thus any analog input may be used as an output and vice-versa. The '4016 devices allow control of up to 12V (peak) analog signals with digital control signals of the same range. Each switch has its own control input which disables each switch when low. All analog inputs and outputs and digital inputs are protected from electrostatic damage by diodes to V_{CC} and ground.

Features

- Typical switch enable time: 15 ns
- Wide analog input voltage range: 0–12V
- Low "on" resistance: 50 Ω typ.
- Low quiescent current: 80 μ A maximum (74HC)
- Matched switch characteristics
- Individual switch controls

Connection Diagram

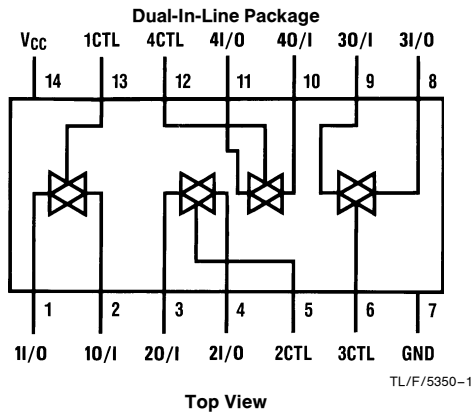

Order Number MM54HC4016 or MM74HC4016

Truth Table

Input	Switch
CTL	I/O-O/I
L	"OFF"
H	"ON"

Schematic Diagram

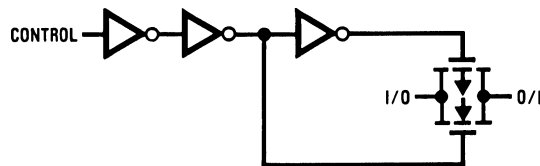

Absolute Maximum Ratings (Notes 1 & 2)

If Military/Aerospace specified devices are required, please contact the National Semiconductor Sales Office/Distributors for availability and specifications.

Supply Voltage (V_{CC})	-0.5 to +15V
DC Control Input Voltage (V_{IN})	-1.5 to $V_{CC} + 1.5V$
DC Switch I/O Voltage (V_{IO})	-0.5 to $V_{CC} + 0.5V$
Clamp Diode Current (I_{IK}, I_{OK})	± 20 mA
DC Output Current, per pin (I_{OUT})	± 25 mA
DC V_{CC} or GND Current, per pin (I_{CC})	± 50 mA
Storage Temperature Range (T_{STG})	-65°C to +150°C
Power Dissipation (P_D) (Note 3)	600 mW
S.O. Package only	500 mW
Lead Temp. (T_L) (Soldering 10 seconds)	260°C

Operating Conditions

	Min	Max	Units
Supply Voltage (V_{CC})	2	12	V
DC Input or Output Voltage (V_{IN}, V_{OUT})	0	V_{CC}	V
Operating Temp. Range (T_A)			
MM74HC	-40	+85	°C
MM54HC	-55	+125	°C
Input Rise or Fall Times (t_r, t_f)			
$V_{CC} = 2.0V$		1000	ns
$V_{CC} = 4.5V$		500	ns
$V_{CC} = 6.0V$		400	ns

DC Electrical Characteristics (Note 4)

Symbol	Parameter	Conditions	V_{CC}	$T_A = 25^\circ C$			Units	
				Typ	Guaranteed Limits			
V_{IH}	Minimum High Level Input Voltage		2.0V		1.5	1.5	V	
			4.5V		3.15	3.15	V	
			9.0V		6.3	6.3	V	
			12.0V		8.4	8.4	V	
V_{IL}	Maximum Low Level Input Voltage**		2.0V		0.5	0.5	V	
			4.5V		1.35	1.35	V	
			9.0V		2.7	2.7	V	
			12.0V		3.6	3.6	V	
R_{ON}	Maximum 'ON' Resistance (See Note 5)	$V_{CTL} = V_{IH}, I_S = 2.0$ mA $V_{IS} = V_{CC}$ to GND (Figure 1)	4.5V	100	170	200	220	Ω
			9.0V	50	85	105	120	Ω
			12.0V	30	70	85	100	Ω
		$V_{CTL} = V_{IH}, I_S = 2.0$ mA $V_{IS} = V_{CC}$ or GND (Figure 1)	2.0V	100	180	215	240	Ω
			4.5V	40	80	100	120	Ω
			9.0V	35	60	75	80	Ω
12.0V	20	40	60	70	Ω			
R_{ON}	Maximum 'ON' Resistance Matching	$V_{CTL} = V_{IH}$ $V_{IS} = V_{CC}$ to GND	4.5V	10	15	20	20	Ω
			9.0V	5	10	15	15	Ω
			12.0V	5	10	15	15	Ω
I_{IN}	Maximum Control Input Current	$V_{IN} = V_{CC}$ or GND	6.0V		± 0.1	± 1.0	± 1.0	μA
I_{IZ}	Maximum Switch 'OFF' Leakage Current	$V_{OS} = V_{CC}$ or GND $V_{IS} = GND$ or V_{CC} $V_{CTL} = V_{IL}$ (Figure 2)	6.0V		± 60	± 600	± 600	nA
			9.0V		± 80	± 800	± 800	nA
			12.0V		± 100	± 1000	± 1000	nA
I_{IZ}	Maximum Switch 'ON' Leakage Current	$V_{IS} = V_{CC}$ to GND $V_{CTL} = V_{IH}, V_{OH} = OPEN$ (Figure 3)	6.0V		± 40	± 150	± 150	nA
			9.0V		± 50	± 200	± 200	nA
			12.0V		± 60	± 300	± 300	nA
I_{CC}	Maximum Quiescent Supply Current	$V_{IN} = V_{CC}$ or GND $I_{OUT} = 0 \mu A$	6.0V		2.0	20	40	μA
			9.0V		4.0	40	80	μA
			12.0V		8.0	80	160	μA

Note 1: Absolute Maximum Ratings are those values beyond which damage to the device may occur.

Note 2: Unless otherwise specified all voltages are referenced to ground.

Note 3: Power Dissipation temperature derating — plastic "N" package: -12 mW/°C from 65°C to 85°C; ceramic "J" package: -12 mW/°C from 100°C to 125°C.

Note 4: For a power supply of 5V $\pm 10\%$ the worst case on resistances (R_{ON}) occurs for HC at 4.5V. Thus the 4.5V values should be used when designing with this supply. Worst case V_{IH} and V_{IL} occur at $V_{CC} = 5.5V$ and 4.5V respectively. (The V_{IH} value at 5.5V is 3.85V.) The worst case leakage current occur for CMOS at the higher voltage and so these values should be used.

Note 5: At supply voltages ($V_{CC} - GND$) approaching 2V the analog switch on resistance becomes extremely non-linear. Therefore it is recommended that these devices be used to transmit digital only when using these supply voltages.

** V_{IL} limits are currently tested at 20% of V_{CC} . The above V_{IL} specification (30% of V_{CC}) will be implemented no later than Q1, CY'89.

AC Electrical Characteristics $V_{CC} = 2.0V-12.0V$, $C_L = 50\text{ pF}$ (unless otherwise specified), (Notes 6 and 7)

Symbol	Parameter	Conditions	V_{CC}	$T_A = 25^\circ\text{C}$		74HC	54HC	Units
						$T_A = -40\text{ to }85^\circ\text{C}$	$T_A = -55\text{ to }125^\circ\text{C}$	
				Typ	Guaranteed Limits			
t_{PHL} , t_{PLH}	Maximum Propagation Delay Switch In to Out		2.0V	25	50	62	75	ns
			4.5V	5	10	13	15	ns
			9.0V	4	8	12	14	ns
			12.0V	3	7	11	13	ns
t_{PZL} , t_{PZH}	Maximum Switch Turn "ON" Delay	$R_L = 1\text{ k}\Omega$	2.0V	32	100	125	150	ns
			4.5V	8	20	25	30	ns
			9.0V	6	12	15	18	ns
			12.0V	5	10	13	15	ns
t_{PHZ} , t_{PLZ}	Maximum Switch Turn "OFF" Delay	$R_L = 1\text{ k}\Omega$	2.0V	45	168	210	252	ns
			4.5V	15	36	45	54	ns
			9.0V	10	32	40	48	ns
			12.0V	8	30	38	45	ns
	Minimum Frequency Response (Figure 7)	$R_L = 600\Omega$, $V_{IS} = 2V_{PP}$ at $(V_{CC}/2)$ (Notes 6 & 7)	4.5V	40				MHz
	Control to Switch Feedthrough Noise (Figure 8)	$R_L = 600\Omega$, $F = 1\text{ MHz}$ $C_L = 50\text{ pF}$ (Notes 7 & 8)	4.5V	100				mV
	Crosstalk Between any Two Switches (Figure 9)	$R_L = 600\Omega$, $F = 1\text{ MHz}$	4.5V	-52				dB
	Switch OFF Signal Feedthrough Isolation (Figure 10)	$R_L = 600\Omega$, $F = 1\text{ MHz}$ $V_{CTL} = V_{IL}$ (Notes 7 & 8)	4.5V	-42				dB
	9.0V	-44					dB	
THD	Sinewave Harmonic Distortion (Figure 11)	$R_L = 10\text{ k}\Omega$, $C_L = 50\text{ pF}$, $F = 1\text{ kHz}$ $V_{IS} = 4V_{PP}$ $V_{IS} = 8V_{PP}$	4.5V	0.013				%
			9.0V	0.008				%
C_{IN}	Maximum Control Input Capacitance			5	10	10	10	pF
C_{IN}	Maximum Switch Input Capacitance			15				pF
C_{IN}	Maximum Feedthrough Capacitance	$V_{CTL} = \text{GND}$		5				pF
C_{PD}	Power Dissipation Capacitance	(per switch)		15				pF

Note 6: Adjust 0 dBm for $F = 1\text{ kHz}$ (Null R_L/R_{ON} Attenuation)

Note 7: V_{IS} is centered at $V_{CC}/2$

Note 8: Adjust input for 0 dBm

AC Test Circuits and Switching Time Waveforms

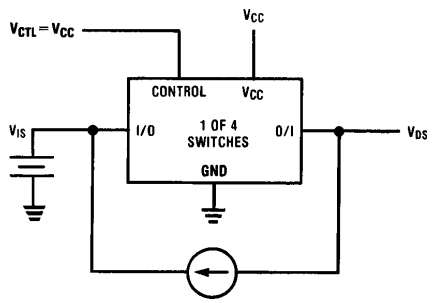

FIGURE 1. "ON" Resistance

TL/F/5350-3

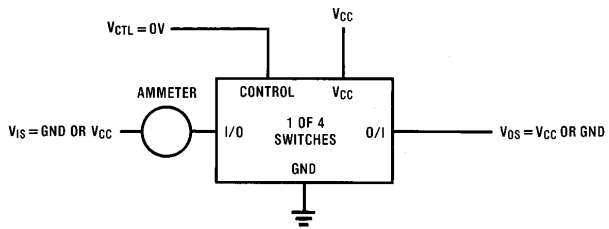

FIGURE 2. "OFF" Channel Leakage Current

TL/F/5350-4

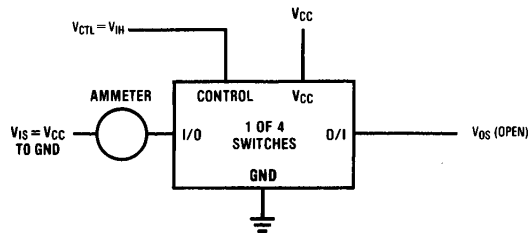
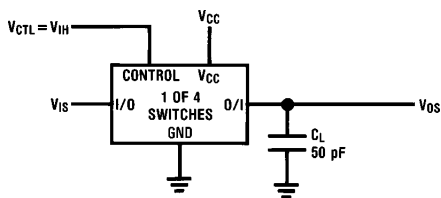

FIGURE 3. "ON" Channel Leakage Current

TL/F/5350-5



TL/F/5350-6

FIGURE 4. t_{pHL} , t_{pLH} Propagation Delay Time Signal Input to Signal Output

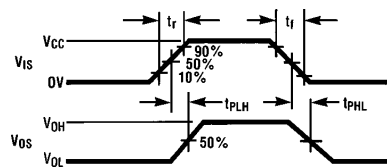

TL/F/5350-7

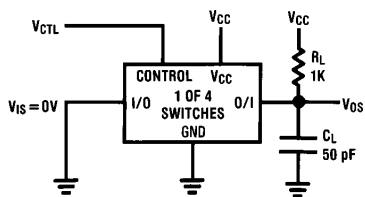

TL/F/5350-8

FIGURE 5. t_{pZL} , t_{pLZ} Propagation Delay Time Control to Signal Output

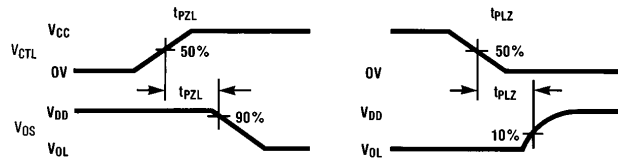

TL/F/5350-9

AC Test Circuits and Switching Time Waveforms (Continued)

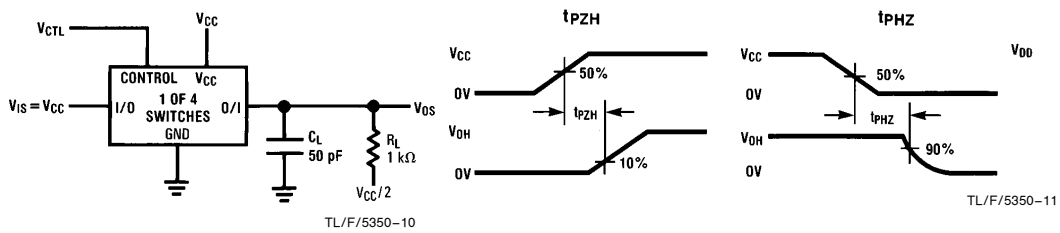

FIGURE 6. t_{PZH} , t_{PHZ} Propagation Delay Time Control to Signal Output

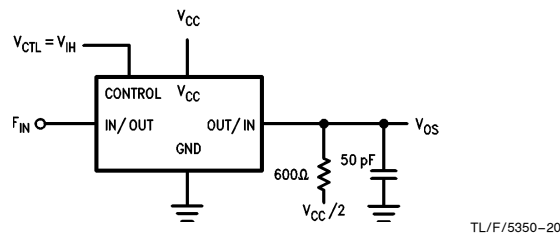

FIGURE 7. Frequency Response

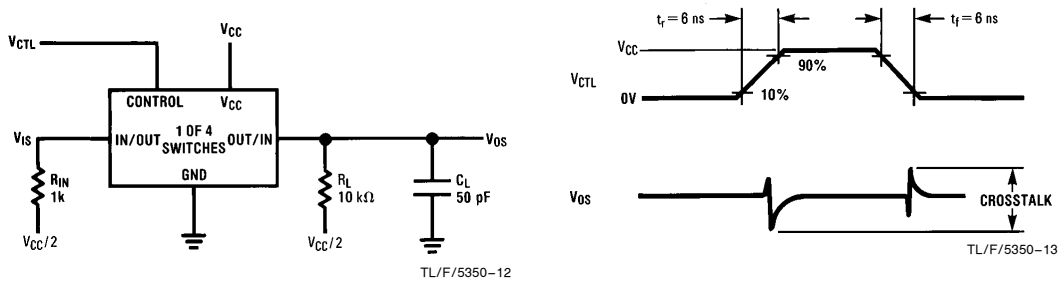

FIGURE 8. Crosstalk: Control Input to Signal Output

AC Test Circuits and Switching Time Waveforms (Continued)

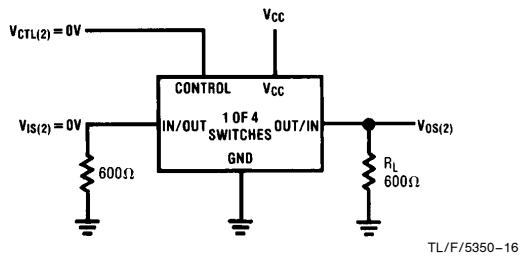
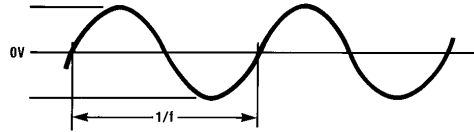
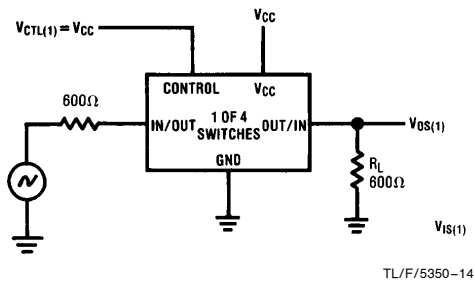

FIGURE 9. Crosstalk Between Any Two Switches

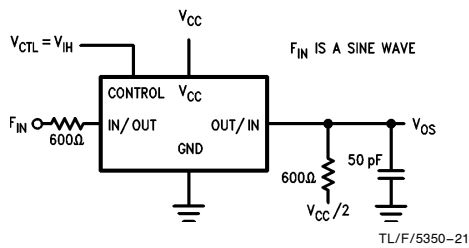

FIGURE 10. Switch OFF Signal Feedthrough Isolation

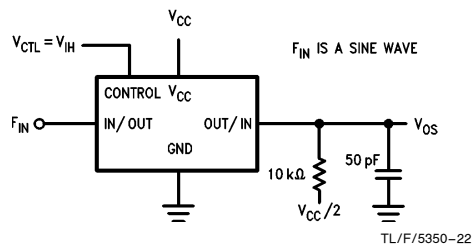
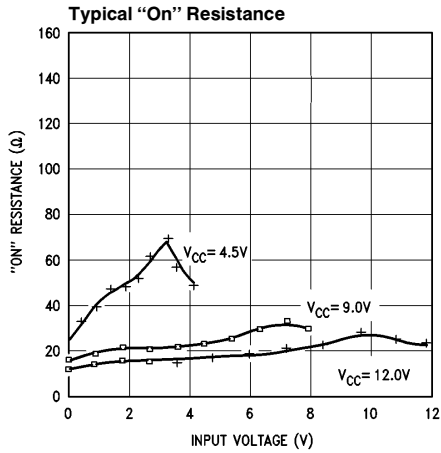
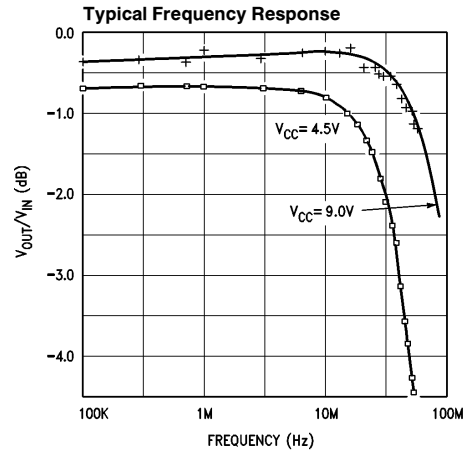

FIGURE 11. Sinewave Distortion

Typical Performance Characteristics



TL/F/5350-19



TL/F/5350-23

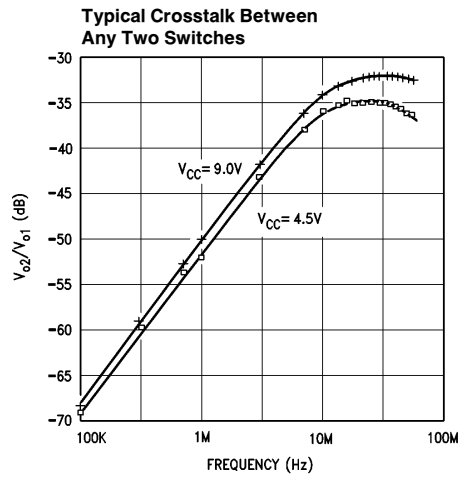

TL/F/5350-24

Special Considerations

In certain applications the external load-resistor current may include both V_{CC} and signal line components. To avoid drawing V_{CC} current when switch current flows into the analog switch input pins, the voltage drop across the switch must not exceed 0.6V (calculated from the ON resistance).

Physical Dimensions inches (millimeters)

Ceramic Dual in Line Pkg (J)
Order Number MM54HC4016J or
MM74HC4016J
NS Package Number J14A

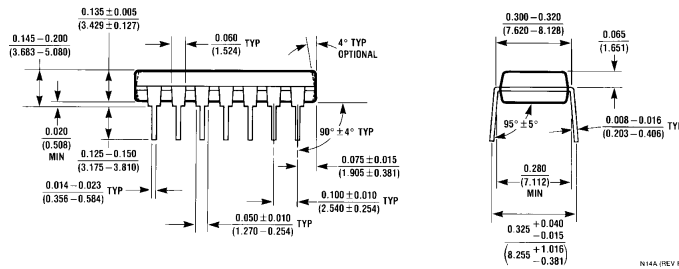
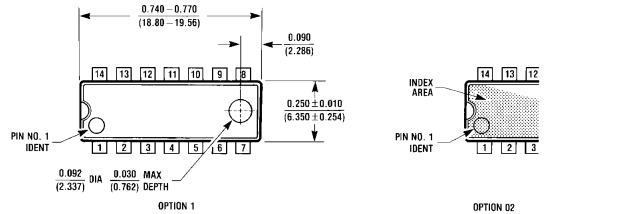
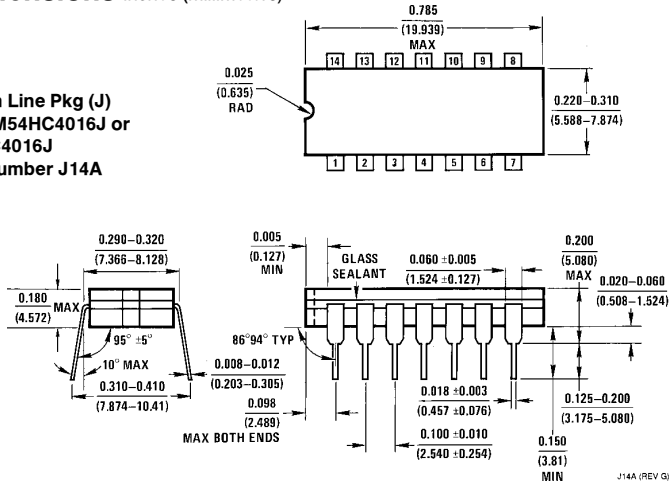

Molded Dual in Line Package (N)
Order Number MM74HC4016N
NS Package Number N14A

LIFE SUPPORT POLICY

NATIONAL'S PRODUCTS ARE NOT AUTHORIZED FOR USE AS CRITICAL COMPONENTS IN LIFE SUPPORT DEVICES OR SYSTEMS WITHOUT THE EXPRESS WRITTEN APPROVAL OF THE PRESIDENT OF NATIONAL SEMICONDUCTOR CORPORATION. As used herein:

1. Life support devices or systems are devices or systems which, (a) are intended for surgical implant into the body, or (b) support or sustain life, and whose failure to perform, when properly used in accordance with instructions for use provided in the labeling, can be reasonably expected to result in a significant injury to the user.
2. A critical component is any component of a life support device or system whose failure to perform can be reasonably expected to cause the failure of the life support device or system, or to affect its safety or effectiveness.

 <p>National Semiconductor Corporation 1111 West Bardin Road Arlington, TX 76017 Tel: 1(800) 272-9959 Fax: 1(800) 737-7018</p>	<p>National Semiconductor Europe Fax: (+49) 0-180-530 85 86 Email: cnjwge@tevm2.nsc.com Deutsch Tel: (+49) 0-180-530 85 85 English Tel: (+49) 0-180-532 78 32 Français Tel: (+49) 0-180-532 93 58 Italiano Tel: (+49) 0-180-534 16 80</p>	<p>National Semiconductor Hong Kong Ltd. 19th Floor, Straight Block, Ocean Centre, 5 Canton Rd. Tsimshatsui, Kowloon Hong Kong Tel: (852) 2737-1600 Fax: (852) 2736-9960</p>	<p>National Semiconductor Japan Ltd. Tel: 81-043-299-2309 Fax: 81-043-299-2408</p>
--	--	---	---

National does not assume any responsibility for use of any circuitry described, no circuit patent licenses are implied and National reserves the right at any time without notice to change said circuitry and specifications.