

MC74AC299, MC74ACT299

8-Input Universal Shift/Storage Register with Common Parallel I/O Pins

The MC74AC299/74ACT299 is an 8-bit universal shift/storage register with 3-state outputs. Four modes of operation are possible: hold (store), shift left, shift right and load data. The parallel load inputs and flip-flop outputs are multiplexed to reduce the total number of package pins. Additional outputs are provided for flip-flops Q₀, Q₇ to allow easy serial cascading. A separate active LOW Master Reset is used to reset the register.

- Common Parallel I/O for Reduced Pin Count
- Additional Serial Inputs and Outputs for Expansion
- Four Operating Modes: Shift Left, Shift Right, Load and Store
- 3-State Outputs for Bus-Oriented Applications
- Outputs Source/Sink 24 mA
- 'ACT299 Has TTL Compatible Inputs

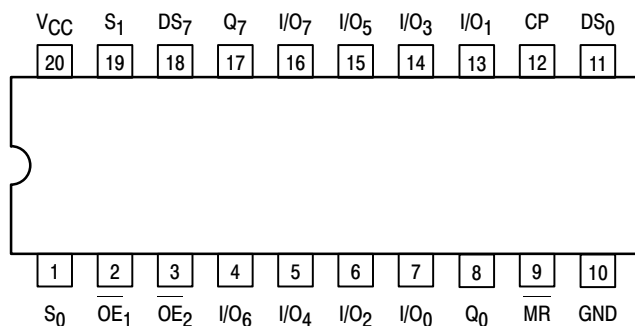

Figure 1. Pinout: 20-Lead Packages Conductors (Top View)

PIN ASSIGNMENT

PIN	FUNCTION
CP	Clock Pulse Input
DS ₀	Serial Data Input for Right Shift
DS ₇	Serial Data Input for Left Shift
S ₀ , S ₁	Mode Select Inputs
MR	Asynchronous Master Reset
OE ₁ , OE ₂	3-State Output Enable Inputs
I/O ₀ –I/O ₇	Parallel Data Inputs or 3-State Parallel Outputs
Q ₀ , Q ₇	Serial Outputs



ON Semiconductor™

<http://onsemi.com>

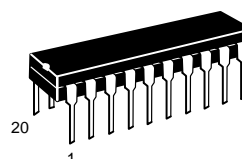

PDIP-20
N SUFFIX
CASE 738

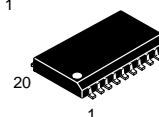

SO-20
DW SUFFIX
CASE 751

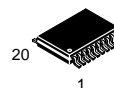

TSSOP-20
DT SUFFIX
CASE 948E

ORDERING INFORMATION

Device	Package	Shipping
MC74AC299N	PDIP-20	18 Units/Rail
MC74ACT299N	PDIP-20	18 Units/Rail
MC74AC299DW	SOIC-20	38 Units/Rail
MC74AC299DWR2	SOIC-20	1000 Tape & Reel
MC74ACT299DW	SOIC-20	38 Units/Rail
MC74ACT299DWR2	SOIC-20	1000 Tape & Reel
MC74AC299DT	TSSOP-20	75 Units/Rail
MC74AC299DTR2	TSSOP-20	2500 Tape & Reel
MC74ACT299DT	TSSOP-20	75 Units/Rail
MC74ACT299DTR2	TSSOP-20	2500 Tape & Reel

DEVICE MARKING INFORMATION

See general marking information in the device marking section on page 9 of this data sheet.

MC74AC299, MC74ACT299

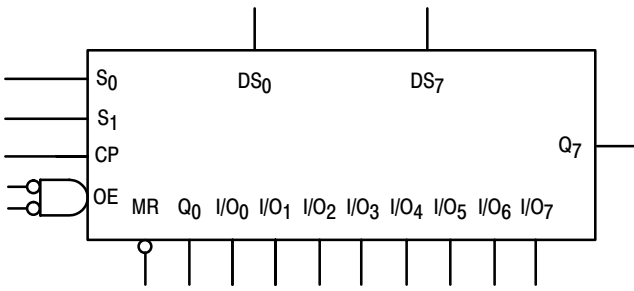
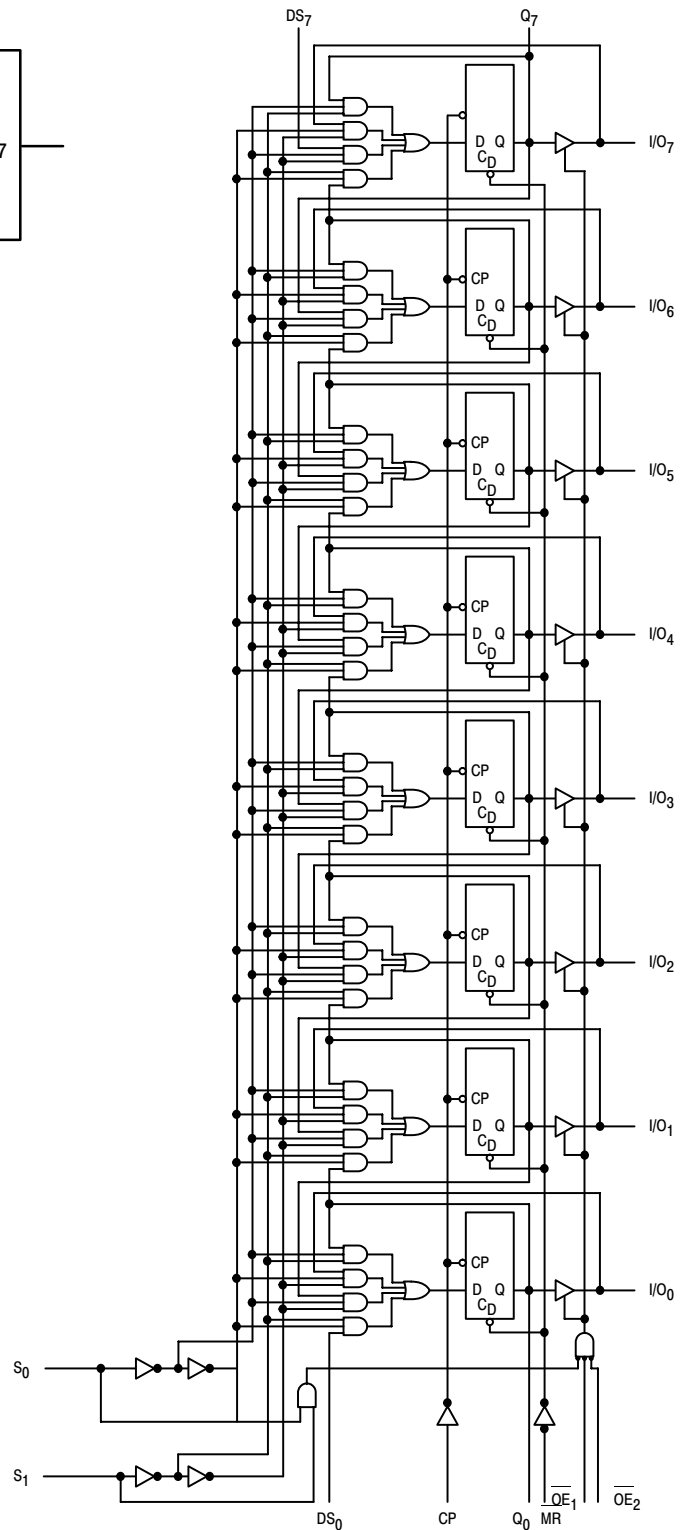

Figure 2. Logic Symbol



NOTE: That this diagram is provided only for the understanding of logic operations and should not be used to estimate propagation delays.

Figure 3. Logic Diagram

MC74AC299, MC74ACT299

FUNCTIONAL DESCRIPTION

The MC74AC299/74ACT299 contains eight edge-triggered D-type flip-flops and the interstage logic necessary to perform synchronous shift left, shift right, parallel load and hold operations. The type of operation is determined by S_0 and S_1 , as shown in the Truth Table. All flip-flop outputs are brought out through 3-state buffers to separate I/O pins that also serve as data inputs in the parallel load mode. Q_0 and Q_7 are also brought out on other pins for expansion in serial shifting of longer words.

A LOW signal on MR overrides the Select and CP inputs and resets the flip-flops. All other state changes are initiated by the rising edge of the clock. Inputs can change when the clock is in either state provided only that the recommended setup and hold times, relative to the rising edge of CP, are observed.

A HIGH signal on either \overline{OE}_1 or \overline{OE}_2 disables the 3-state buffers and puts the I/O pins in the high impedance state. In this condition the shift, hold, load and reset operations can still occur. The 3-state buffers are also disabled by HIGH signals on both S_0 and S_1 in preparation for a parallel load operation.

TRUTH TABLE

Inputs				Response
MR	S_1	S_0	CP	
L	X	X	X	Asynchronous Reset; Q_0 – Q_7 = LOW
H	H	H	\uparrow	Parallel Load; $I/O_n \rightarrow Q_n$
H	L	H	\uparrow	Shift Rights; $DS_0 \rightarrow Q_0$, $Q_0 \rightarrow Q_1$, etc.
H	H	L	\uparrow	Shift Left; $DS_7 \rightarrow Q_7$, $Q_7 \rightarrow Q_6$, etc.
H	L	L	X	Hold

H = HIGH Voltage Level

L = LOW Voltage Level

X = Immaterial

\uparrow = LOW-to-HIGH Transition

MAXIMUM RATINGS*

Symbol	Parameter	Value	Unit
V_{CC}	DC Supply Voltage (Referenced to GND)	–0.5 to +7.0	V
V_{IN}	DC Input Voltage (Referenced to GND)	–0.5 to V_{CC} +0.5	V
V_{OUT}	DC Output Voltage (Referenced to GND)	–0.5 to V_{CC} +0.5	V
I_{IN}	DC Input Current, per Pin	± 20	mA
I_{OUT}	DC Output Sink/Source Current, per Pin	± 50	mA
I_{CC}	DC V_{CC} or GND Current per Output Pin	± 50	mA
T_{stg}	Storage Temperature	–65 to +150	°C

*Maximum Ratings are those values beyond which damage to the device may occur. Functional operation should be restricted to the Recommended Operating Conditions.

RECOMMENDED OPERATING CONDITIONS

Symbol	Parameter	Min	Typ	Max	Unit	
V_{CC}	Supply Voltage	'AC	2.0	5.0	6.0	V
		'ACT	4.5	5.0	5.5	
V_{IN}, V_{OUT}	DC Input Voltage, Output Voltage (Ref. to GND)	0	–	V_{CC}	V	
t_r, t_f	Input Rise and Fall Time (Note 1) 'AC Devices except Schmitt Inputs	V_{CC} @ 3.0 V	–	150	–	ns/V
		V_{CC} @ 4.5 V	–	40	–	
		V_{CC} @ 5.5 V	–	25	–	
t_r, t_f	Input Rise and Fall Time (Note 2) 'ACT Devices except Schmitt Inputs	V_{CC} @ 4.5 V	–	10	–	ns/V
		V_{CC} @ 5.5 V	–	8.0	–	
T_J	Junction Temperature (PDIP)	–	–	140	°C	
T_A	Operating Ambient Temperature Range	–40	25	85	°C	
I_{OH}	Output Current – High	–	–	–24	mA	
I_{OL}	Output Current – Low	–	–	24	mA	

1. V_{IN} from 30% to 70% V_{CC} ; see individual Data Sheets for devices that differ from the typical input rise and fall times.

2. V_{IN} from 0.8 V to 2.0 V; see individual Data Sheets for devices that differ from the typical input rise and fall times.

MC74AC299, MC74ACT299

DC CHARACTERISTICS

Symbol	Parameter	V _{CC} (V)	74AC		74AC		Unit	Conditions
			T _A = +25°C		T _A = -40°C to +85°C			
			Typ	Guaranteed Limits				
V _{IH}	Minimum High Level Input Voltage	3.0	1.5	2.1	2.1	V	V _{OUT} = 0.1 V or V _{CC} - 0.1 V	
		4.5	2.25	3.15	3.15			
		5.5	2.75	3.85	3.85			
V _{IL}	Maximum Low Level Input Voltage	3.0	1.5	0.9	0.9	V	V _{OUT} = 0.1 V or V _{CC} - 0.1 V	
		4.5	2.25	1.35	1.35			
		5.5	2.75	1.65	1.65			
V _{OH}	Minimum High Level Output Voltage	3.0	2.99	2.9	2.9	V	I _{OUT} = -50 μA	
		4.5	4.49	4.4	4.4			
		5.5	5.49	5.4	5.4			
	3.0	4.5	5.5	-	2.56	2.46	V	*V _{IN} = V _{IL} or V _{IH} -12 mA I _{OH} -24 mA -24 mA
				-	3.86	3.76		
				-	4.86	4.76		
V _{OL}	Maximum Low Level Output Voltage	3.0	0.002	0.1	0.1	V	I _{OUT} = 50 μA	
		4.5	0.001	0.1	0.1			
		5.5	0.001	0.1	0.1			
	3.0	4.5	5.5	-	0.36	0.44	V	*V _{IN} = V _{IL} or V _{IH} 12 mA I _{OL} 24 mA 24 mA
				-	0.36	0.44		
				-	0.36	0.44		
I _{IN}	Maximum Input Leakage Current	5.5	-	±0.1	±1.0	μA	V _I = V _{CC} , GND	
I _{OZT}	Maximum 3-State Current	5.5	-	±0.6	±6.0	μA	V _I (OE) = V _{IL} , V _{IH} V _I = V _{CC} , GND V _O = V _{CC} , GND	
I _{OLD}	†Minimum Dynamic Output Current	5.5	-	-	75	mA	V _{OLD} = 1.65 V Max	
I _{OHD}		5.5	-	-	-75	mA	V _{OHD} = 3.85 V Min	
I _{CC}	Maximum Quiescent Supply Current	5.5	-	8.0	80	μA	V _{IN} = V _{CC} or GND	

*All outputs loaded; thresholds on input associated with output under test.

†Maximum test duration 2.0 ms, one output loaded at a time.

NOTE: I_{IN} and I_{CC} @ 3.0 V are guaranteed to be less than or equal to the respective limit @ 5.5 V V_{CC}.

AC CHARACTERISTICS (For Figures and Waveforms – See Section 3 of the ON Semiconductor FACT Data Book, DL138/D)

Symbol	Parameter	V _{CC} * (V)	74AC			74AC		Unit	Fig. No.
			T _A = +25°C C _L = 50 pF			T _A = -40°C to +85°C C _L = 50 pF			
			Min	Typ	Max	Min	Max		
f _{max}	Maximum Input Frequency	3.3	90	-	-	80	-	MHz	3-3
		5.0	130	-	-	105	-		
t _{PLH}	Propagation Delay CP to Q ₀ or Q ₇	3.3	8.5	-	20.5	7.0	22	ns	3-6
		5.0	5.5	-	14	4.5	15		
t _{PHL}	Propagation Delay CP to Q ₀ or Q ₇	3.3	8.5	-	21.5	7.0	23	ns	3-6
		5.0	5.5	-	14.5	5.0	16		

*Voltage Range 3.3 V is 3.3 V ±0.3 V.

Voltage Range 5.0 V is 5.0 V ±0.5 V.

MC74AC299, MC74ACT299

AC CHARACTERISTICS (For Figures and Waveforms – See Section 3 of the ON Semiconductor FACT Data Book, DL138/D)

Symbol	Parameter	V _{CC} * (V)	74AC			74AC		Unit	Fig. No.
			T _A = +25°C C _L = 50 pF			T _A = -40°C to +85°C C _L = 50 pF			
			Min	Typ	Max	Min	Max		
t _{PLH}	Propagation Delay CP to I/O _n	3.3	9.0	–	20.5	7.5	22.5	ns	3–6
		5.0	6.0	–	14.5	5.0	16		
t _{PHL}	Propagation Delay CP to I/O _n	3.3	10	–	23	8.5	24.5	ns	3–6
		5.0	6.5	–	16	6.0	17.5		
t _{PHL}	Propagation Delay MR to Q ₀ or Q ₇	3.3	9.0	–	22.5	7.5	25.0	ns	3–6
		5.0	5.5	–	15.5	5.0	17.0		
t _{PHL}	Propagation Delay MR to I/O _n	3.3	9.0	–	21.5	7.5	24.0	ns	3–6
		5.0	5.5	–	15.0	5.0	16.5		
t _{PZH}	Output Enable Time OE to I/O _n	3.3	7.0	–	18	6.0	19.5	ns	3–7
		5.0	4.5	–	12.5	4.0	13.5		
t _{PZL}	Output Enable Time OE to I/O _n	3.3	7.0	–	18	6.0	20.5	ns	3–8
		5.0	5.0	–	12.5	4.0	14		
t _{PHZ}	Output Disable Time OE to I/O _n	3.3	6.5	–	18.5	5.5	19.5	ns	3–7
		5.0	3.5	–	14	3.0	15		
t _{PLZ}	Output Disable Time OE to I/O _n	3.3	5.5	–	17	4.5	19	ns	3–8
		5.0	3.5	–	12.5	2.0	13.5		

*Voltage Range 3.3 V is 3.3 V ±0.3 V.
Voltage Range 5.0 V is 5.0 V ±0.5 V.

AC OPERATING REQUIREMENTS

Symbol	Parameter	V _{CC} * (V)	74AC		74AC		Unit	Fig. No.
			T _A = +25°C C _L = 50 pF		T _A = -40°C to +85°C C _L = 50 pF			
			Typ	Guaranteed Minimum				
t _s	Setup Time, HIGH or LOW S ₀ or S ₁ to CP	3.3	–	8.0	8.5	ns	3–9	
		5.0	–	5.0	5.5			
t _h	Hold Time, HIGH or LOW S ₀ or S ₁ to CP	3.3	–	0.5	0.5	ns	3–9	
		5.0	–	1.0	1.0			
t _s	Setup Time, HIGH or LOW I/O _n to CP	3.3	–	5.5	6.0	ns	3–9	
		5.0	–	3.5	4.0			
t _h	Hold Time, HIGH or LOW I/O _n to CP	3.3	–	0	0	ns	3–9	
		5.0	–	1.0	1.0			
t _s	Setup Time, HIGH or LOW DS ₀ or DS ₇ to CP	3.3	–	6.5	7.0	ns	3–6	
		5.0	–	4.0	4.5			
t _h	Hold Time, HIGH or LOW DS ₀ or DS ₇ to CP	3.3	–	0	0.5	ns	3–6	
		5.0	–	1.0	1.0			
t _w	CP Pulse Width, LOW	3.3	–	4.5	5.0	ns	3–6	
		5.0	–	3.5	3.5			
t _w	MR Pulse Width, LOW	3.3	–	4.5	5.0	ns	3–9	
		5.0	–	3.5	3.5			
t _{rec}	Recovery Time MR to CP	3.3	–	1.5	1.5	ns	3–9	
		5.0	–	1.5	1.5			

*Voltage Range 3.3 V is 3.3 V ±0.3 V.
Voltage Range 5.0 V is 5.0 V ±0.5 V.

MC74AC299, MC74ACT299

DC CHARACTERISTICS

Symbol	Parameter	V _{CC} (V)	74ACT		74ACT		Unit	Conditions
			T _A = +25°C		T _A = -40°C to +85°C			
			Typ	Guaranteed Limits				
V _{IH}	Minimum High Level Input Voltage	4.5	1.5	2.0	2.0	V	V _{OUT} = 0.1 V or V _{CC} - 0.1 V	
		5.5	1.5	2.0	2.0			
V _{IL}	Maximum Low Level Input Voltage	4.5	1.5	0.8	0.8	V	V _{OUT} = 0.1 V or V _{CC} - 0.1 V	
		5.5	1.5	0.8	0.8			
V _{OH}	Minimum High Level Output Voltage	4.5	4.49	4.4	4.4	V	I _{OUT} = -50 μA	
		5.5	5.49	5.4	5.4			
		4.5	-	3.86	3.76	V	*V _{IN} = V _{IL} or V _{IH} -24 mA I _{OH} = -24 mA	
		5.5	-	4.86	4.76			
V _{OL}	Maximum Low Level Output Voltage	4.5	0.001	0.1	0.1	V	I _{OUT} = 50 μA	
		5.5	0.001	0.1	0.1			
		4.5	-	0.36	0.44	V	*V _{IN} = V _{IL} or V _{IH} 24 mA I _{OL} = 24 mA	
		5.5	-	0.36	0.44			
I _{IN}	Maximum Input Leakage Current	5.5	-	±0.1	±1.0	μA	V _I = V _{CC} , GND	
I _{OZT}	Maximum 3-State Current	5.5	-	±0.6	±6.0	μA	V _I (OE) = V _{IL} , V _{IH} V _I = V _{CC} , GND V _O = V _{CC} , GND	
ΔI _{CCT}	Additional Max. I _{CC} /Input	5.5	0.6	-	1.5	mA	V _I = V _{CC} - 2.1 V	
I _{OLD}	†Minimum Dynamic Output Current	5.5	-	-	75	mA	V _{OLD} = 1.65 V Max	
I _{OHD}		5.5	-	-	-75	mA	V _{OHD} = 3.85 V Min	
I _{CC}	Maximum Quiescent Supply Current	5.5	-	8.0	80	μA	V _{IN} = V _{CC} or GND	

*All outputs loaded; thresholds on input associated with output under test.

†Maximum test duration 2.0 ms, one output loaded at a time.

MC74AC299, MC74ACT299

AC CHARACTERISTICS (For Figures and Waveforms – See Section 3 of the ON Semiconductor FACT Data Book, DL138/D)

Symbol	Parameter	V _{CC} * (V)	74ACT			74ACT		Unit	Fig. No.
			T _A = +25°C C _L = 50 pF			T _A = -40°C to +85°C C _L = 50 pF			
			Min	Typ	Max	Min	Max		
f _{max}	Maximum Input Frequency	5.0	120	–	–	110	–	MHz	3–3
t _{PLH}	Propagation Delay CP to Q ₀ or Q ₇	5.0	4.0	–	12.5	3.0	14	ns	3–6
t _{PHL}	Propagation Delay CP to Q ₀ or Q ₇	5.0	4.0	–	13.5	3.5	15	ns	3–6
t _{PLH}	Propagation Delay CP to I/O _n	5.0	4.5	–	12.5	4.5	13.5	ns	3–6
t _{PHL}	Propagation Delay CP to I/O _n	5.0	5.0	–	15	4.5	16.5	ns	3–6
t _{PHL}	Propagation Delay MR to Q ₀ or Q ₇	5.0	4.0	–	15	4.0	18	ns	3–6
t _{PHL}	Propagation Delay MR to I/O _n	5.0	4.0	–	14.5	3.5	17.5	ns	3–6
t _{PZH}	Output Enable Time OE to I/O _n	5.0	2.5	–	12	1.5	13	ns	3–7
t _{PZL}	Output Enable Time OE to I/O _n	5.0	2.0	–	12	1.5	13.5	ns	3–8
t _{PHZ}	Output Disable Time OE to I/O _n	5.0	2.0	–	12.5	2.0	13.5	ns	3–7
t _{PLZ}	Output Disable Time OE to I/O _n	5.0	2.5	–	11.5	2.0	12.5	ns	3–8

*Voltage Range 5.0 V is 5.0 V ±0.5 V.

MC74AC299, MC74ACT299

AC OPERATING REQUIREMENTS

Symbol	Parameter	V _{CC} * (V)	74ACT		74ACT		Unit	Fig. No.
			T _A = +25°C C _L = 50 pF		T _A = -40°C to +85°C C _L = 50 pF			
			Typ	Guaranteed Minimum				
t _s	Setup Time, HIGH or LOW S ₀ or S ₁ to CP	5.0	–	5.0	5.5	ns	3–9	
t _h	Hold Time, HIGH or LOW S ₀ or S ₁ to CP	5.0	–	1.0	1.0	ns	3–9	
t _s	Setup Time, HIGH or LOW I/O _n to CP	5.0	–	4.0	4.5	ns	3–9	
t _h	Hold Time, HIGH or LOW I/O _n to CP	5.0	–	1.0	1.0	ns	3–9	
t _s	Setup Time, HIGH or LOW DS ₀ or DS ₇ to CP	5.0	–	4.5	5.0	ns	3–6	
t _h	Hold Time, HIGH or LOW DS ₀ or DS ₇ to CP	5.0	–	1.0	1.0	ns	3–6	
t _w	CP Pulse Width HIGH or LOW	5.0	–	4.0	4.5	ns	3–9	
t _w	MR Pulse Width, LOW	5.0	–	3.5	3.5	ns	3–9	
t _{rec}	Recovery Time MR to CP	5.0	–	1.5	1.5	ns	3–9	

*Voltage Range 5.0 V is 5.0 V ±0.5 V.

CAPACITANCE

Symbol	Parameter	Value Typ	Unit	Test Conditions
C _{IN}	Input Capacitance	4.5	pF	V _{CC} = 5.0 V
C _{PD}	Power Dissipation Capacitance	170	pF	V _{CC} = 5.0 V

MC74AC299, MC74ACT299

MARKING DIAGRAMS

PDIP-20

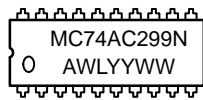

SO-20



TSSOP-20

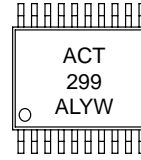
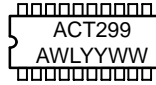
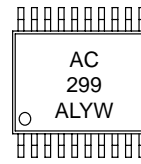

A = Assembly Location
WL, L = Wafer Lot
YY, Y = Year
WW, W = Work Week

MC74AC299, MC74ACT299

PACKAGE DIMENSIONS

PDIP-20
N SUFFIX
 20 PIN PLASTIC DIP PACKAGE
 CASE 738-03
 ISSUE E

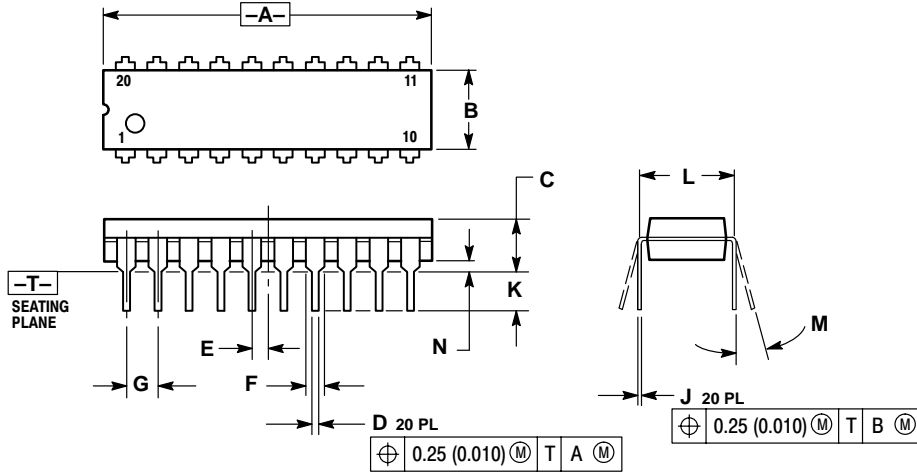

- NOTES:
1. DIMENSIONING AND TOLERANCING PER ANSI Y14.5M, 1982.
 2. CONTROLLING DIMENSION: INCH.
 3. DIMENSION L TO CENTER OF LEAD WHEN FORMED PARALLEL.
 4. DIMENSION B DOES NOT INCLUDE MOLD FLASH.

DIM	INCHES		MILLIMETERS	
	MIN	MAX	MIN	MAX
A	1.010	1.070	25.66	27.17
B	0.240	0.260	6.10	6.60
C	0.150	0.180	3.81	4.57
D	0.015	0.022	0.39	0.55
E	0.050 BSC		1.27 BSC	
F	0.050	0.070	1.27	1.77
G	0.100 BSC		2.54 BSC	
J	0.008	0.015	0.21	0.38
K	0.110	0.140	2.80	3.55
L	0.300 BSC		7.62 BSC	
M	0°	15°	0°	15°
N	0.020	0.040	0.51	1.01

SO-20
DW SUFFIX
 20 PIN PLASTIC SOIC PACKAGE
 CASE 751D-05
 ISSUE F

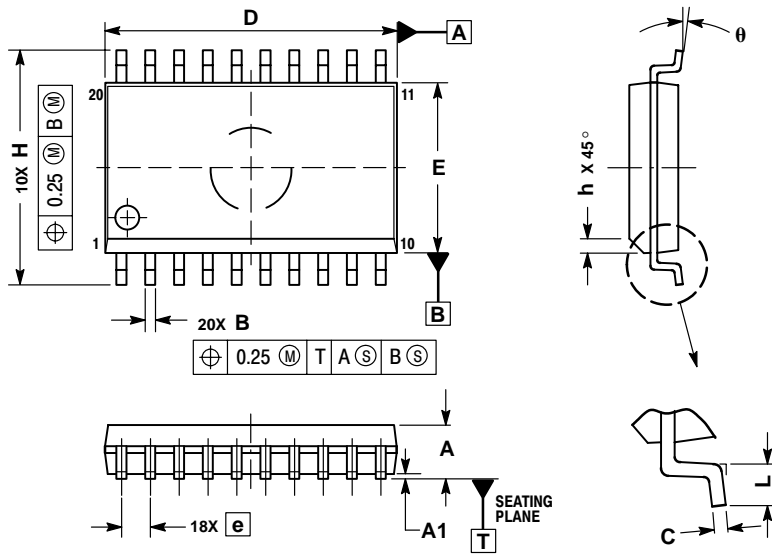

- NOTES:
1. DIMENSIONS ARE IN MILLIMETERS.
 2. INTERPRET DIMENSIONS AND TOLERANCES PER ASME Y14.5M, 1994.
 3. DIMENSIONS D AND E DO NOT INCLUDE MOLD PROTRUSION.
 4. MAXIMUM MOLD PROTRUSION 0.15 PER SIDE.
 5. DIMENSION B DOES NOT INCLUDE DAMBAR PROTRUSION. ALLOWABLE PROTRUSION SHALL BE 0.13 TOTAL IN EXCESS OF B DIMENSION AT MAXIMUM MATERIAL CONDITION.

DIM	MILLIMETERS	
	MIN	MAX
A	2.35	2.65
A1	0.10	0.25
B	0.35	0.49
C	0.23	0.32
D	12.65	12.95
E	7.40	7.60
e	1.27 BSC	
H	10.05	10.55
h	0.25	0.75
L	0.50	0.90
θ	0°	7°

MC74AC299, MC74ACT299

PACKAGE DIMENSIONS

TSSOP-20
DT SUFFIX
20 PIN PLASTIC TSSOP PACKAGE
CASE 948E-02
ISSUE A

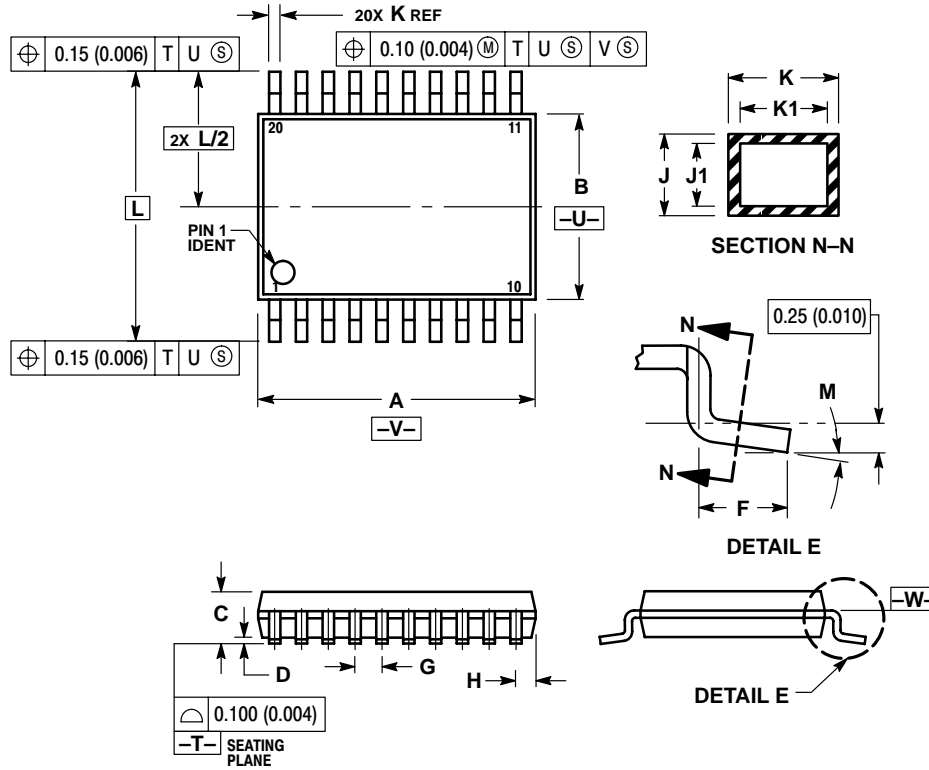

NOTES:

1. DIMENSIONING AND TOLERANCING PER ANSI Y14.5M, 1982.
2. CONTROLLING DIMENSION: MILLIMETER.
3. DIMENSION A DOES NOT INCLUDE MOLD FLASH, PROTRUSIONS OR GATE BURRS. MOLD FLASH OR GATE BURRS SHALL NOT EXCEED 0.15 (0.006) PER SIDE.
4. DIMENSION B DOES NOT INCLUDE INTERLEAD FLASH OR PROTRUSION. INTERLEAD FLASH OR PROTRUSION SHALL NOT EXCEED 0.25 (0.010) PER SIDE.
5. DIMENSION K DOES NOT INCLUDE DAMBAR PROTRUSION. ALLOWABLE DAMBAR PROTRUSION SHALL BE 0.08 (0.003) TOTAL IN EXCESS OF THE K DIMENSION AT MAXIMUM MATERIAL CONDITION.
6. TERMINAL NUMBERS ARE SHOWN FOR REFERENCE ONLY.
7. DIMENSION A AND B ARE TO BE DETERMINED AT DATUM PLANE -W-.

DIM	MILLIMETERS		INCHES	
	MIN	MAX	MIN	MAX
A	6.40	6.60	0.252	0.260
B	4.30	4.50	0.169	0.177
C	---	1.20	---	0.047
D	0.05	0.15	0.002	0.006
F	0.50	0.75	0.020	0.030
G	0.65 BSC		0.026 BSC	
H	0.27	0.37	0.011	0.015
J	0.09	0.20	0.004	0.008
J1	0.09	0.16	0.004	0.006
K	0.19	0.30	0.007	0.012
K1	0.19	0.25	0.007	0.010
L	6.40 BSC		0.252 BSC	
M	0°	8°	0°	8°

MC74AC299, MC74ACT299

ON Semiconductor and  are trademarks of Semiconductor Components Industries, LLC (SCILLC). SCILLC reserves the right to make changes without further notice to any products herein. SCILLC makes no warranty, representation or guarantee regarding the suitability of its products for any particular purpose, nor does SCILLC assume any liability arising out of the application or use of any product or circuit, and specifically disclaims any and all liability, including without limitation special, consequential or incidental damages. "Typical" parameters which may be provided in SCILLC data sheets and/or specifications can and do vary in different applications and actual performance may vary over time. All operating parameters, including "Typicals" must be validated for each customer application by customer's technical experts. SCILLC does not convey any license under its patent rights nor the rights of others. SCILLC products are not designed, intended, or authorized for use as components in systems intended for surgical implant into the body, or other applications intended to support or sustain life, or for any other application in which the failure of the SCILLC product could create a situation where personal injury or death may occur. Should Buyer purchase or use SCILLC products for any such unintended or unauthorized application, Buyer shall indemnify and hold SCILLC and its officers, employees, subsidiaries, affiliates, and distributors harmless against all claims, costs, damages, and expenses, and reasonable attorney fees arising out of, directly or indirectly, any claim of personal injury or death associated with such unintended or unauthorized use, even if such claim alleges that SCILLC was negligent regarding the design or manufacture of the part. SCILLC is an Equal Opportunity/Affirmative Action Employer.

PUBLICATION ORDERING INFORMATION

Literature Fulfillment:

Literature Distribution Center for ON Semiconductor
P.O. Box 5163, Denver, Colorado 80217 USA
Phone: 303-675-2175 or 800-344-3860 Toll Free USA/Canada
Fax: 303-675-2176 or 800-344-3867 Toll Free USA/Canada
Email: ONlit@hibbertco.com

N. American Technical Support: 800-282-9855 Toll Free USA/Canada

JAPAN: ON Semiconductor, Japan Customer Focus Center
4-32-1 Nishi-Gotanda, Shinagawa-ku, Tokyo, Japan 141-0031
Phone: 81-3-5740-2700
Email: r14525@onsemi.com

ON Semiconductor Website: <http://onsemi.com>

For additional information, please contact your local Sales Representative.