

*Not Recommended for New Designs*  
*Consider MC12083 or MC10EL32*

## UHF Prescaler

The MC12090 is a high-speed D master-slave flip-flop capable of toggle rates of over 700MHz. It was designed primarily for high-speed prescaling applications in communications and instrumentation. This device employs two data inputs, two clock inputs as well as complementary Q and  $\bar{Q}$  outputs. There are no SET or RESET inputs.

Pinout: 16-Lead Plastic (Top View)

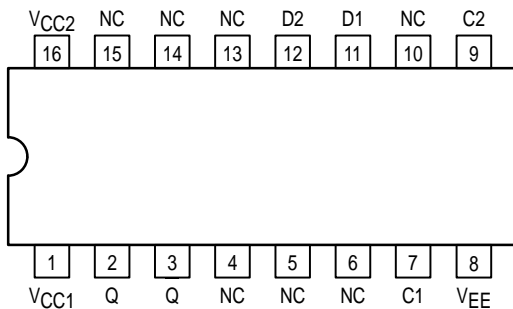

LOGIC DIAGRAM

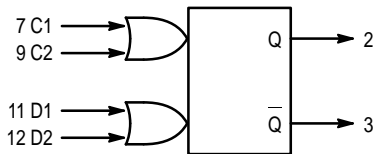

VCC1 = Pin 1  
VCC2 = Pin 16  
VEE = Pin 8

TRUTH TABLE

C	D	Q <sub>n</sub> + 1
L	X	Q <sub>n</sub>
H	X	Q <sub>n</sub>
	L	L
	H	H

C = C1 + C2, X = Don't Care  
D = D1 + D2

# MC12090

## MECL PLL COMPONENTS

### HIGH-SPEED PRESCALER

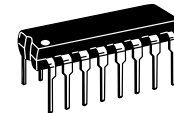

**P SUFFIX**  
16-LEAD PLASTIC PACKAGE  
CASE 648-08

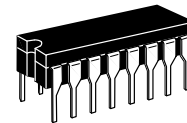

**L SUFFIX**  
16-LEAD CERAMIC PACKAGE  
CASE 620-10

## ELECTRICAL CHARACTERISTICS

Symbol	Characteristic	0°C		25°C		75°C		Unit
		Min	Max	Min	Max	Min	Max	
I <sub>E</sub>	Power Supply Current		65		59		65	mA
I <sub>inH</sub>	Input Current HIGH Pins 7,9 Pins 11,12		400 435		260 280		260 280	μA
I <sub>inL</sub>	Input Current LOW	0.5		0.5		0.3		μA
V <sub>OH</sub>	Output Voltage HIGH	-1.02	-0.84	-0.98	-0.81	-0.92	-0.735	Vdc
V <sub>OL</sub>	Output Voltage LOW	-1.95	-1.63	-1.95	-1.63	-1.95	-1.60	Vdc
V <sub>IH</sub>	Input Voltage HIGH	-1.17	-0.84	-1.13	-0.81	-1.70	-0.735	Vdc
V <sub>IL</sub>	Input Voltage LOW	-1.87	-1.495	-1.85	-1.48	-1.83	-1.45	Vdc



**ELECTRICAL CHARACTERISTICS**

Symbol	Characteristic	-30°C		0°C		25°C		75°C		85°C		Unit
		Min	Max	Min	Max	Min	Max	Min	Max	Min	Max	
$f_{tog}$	Toggle Frequency											MHz
<b>Typical (25°C)</b>												
$t_{pd}$	Propagation Delay (Clock to Output Pins 7,9,12)	1.3										ns
$t_s$	Setup Time	$t_{setup H}$		$t_{setup L}$		0.3		0.3				ns
$t_h$	Hold Time	$t_{hold H}$		$t_{hold L}$		0.3		0.3				ns
$t_r$	Rise Time	0.9										ns
$t_f$	Fall Time	0.9										ns

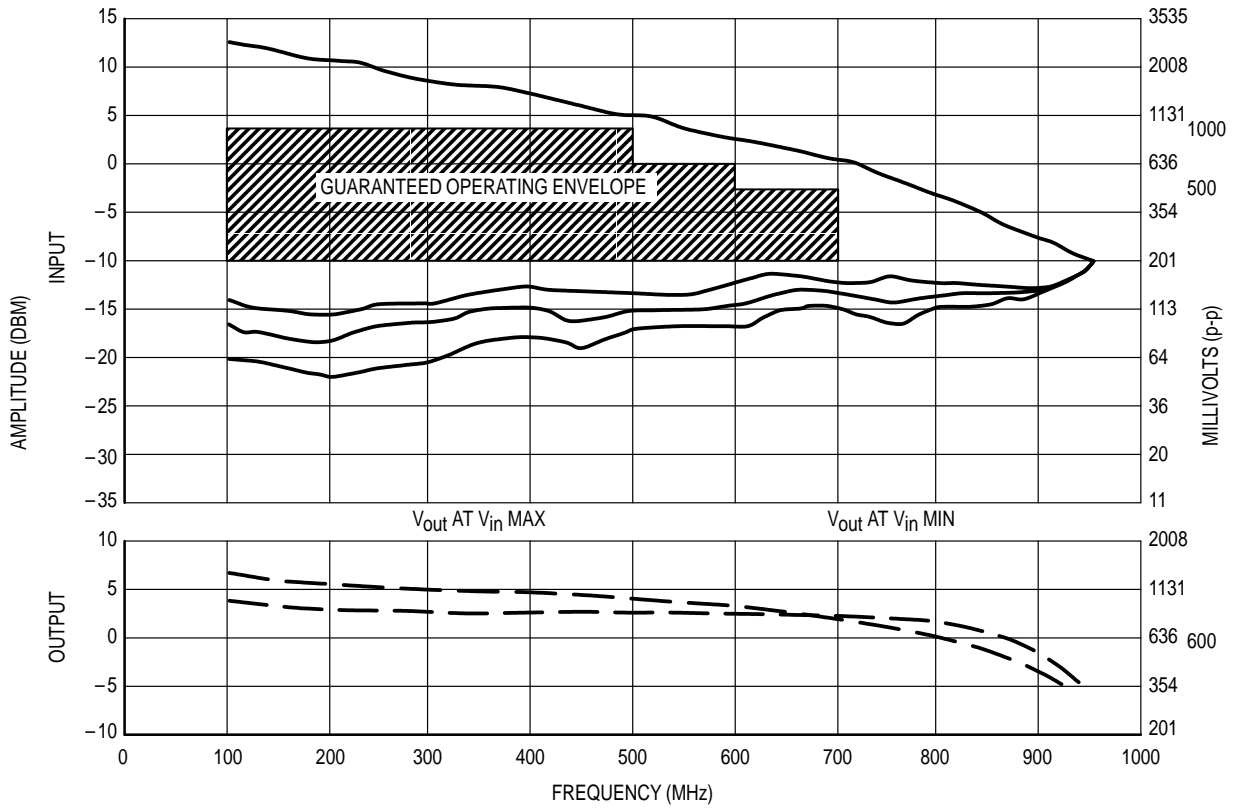

**Figure 1. Guaranteed Range of Operation**  
 (Temp = 75°C, 5 Devices, VCC = 2.0V, VEE = -3.2V, VBias = 0.710V)

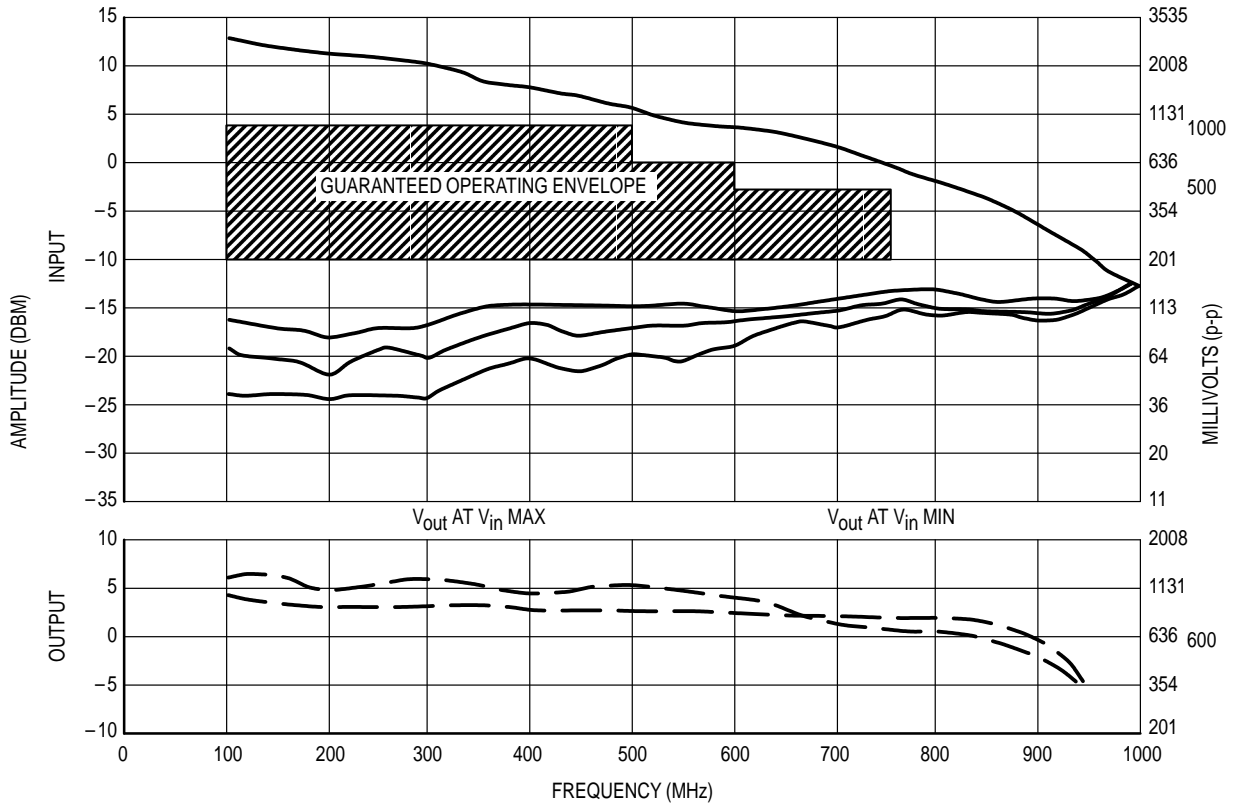

**Figure 2. Guaranteed Range of Operation**  
 (Temp = 25°C, 5 Devices, V<sub>CC</sub> = 2.0V, V<sub>EE</sub> = -3.2V, V<sub>Bias</sub> = 0.710V)

OUTLINE DIMENSIONS

**L SUFFIX  
CERAMIC PACKAGE  
CASE 620-10  
ISSUE V**

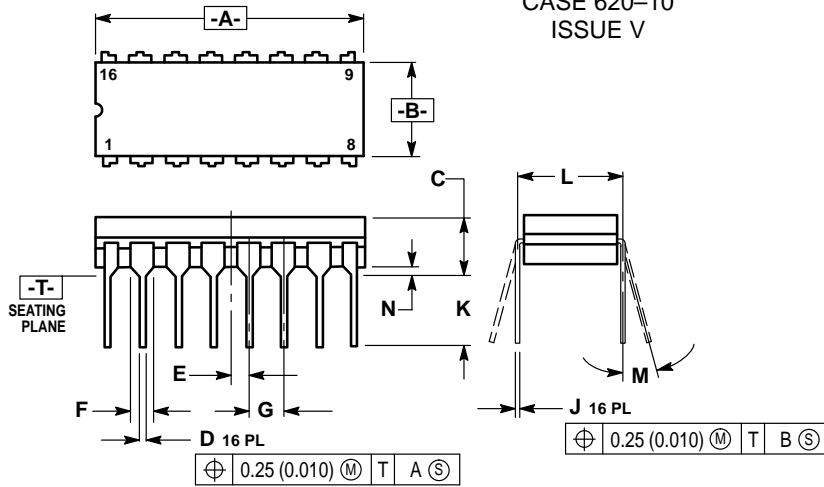

- NOTES:
1. DIMENSIONING AND TOLERANCING PER ANSI Y14.5M, 1982.
  2. CONTROLLING DIMENSION: INCH.
  3. DIMENSION L TO CENTER OF LEAD WHEN FORMED PARALLEL.
  4. DIMENSION F MAY NARROW TO 0.76 (0.030) WHERE THE LEAD ENTERS THE CERAMIC BODY.

DIM	INCHES		MILLIMETERS	
	MIN	MAX	MIN	MAX
A	0.750	0.785	19.05	19.93
B	0.240	0.295	6.10	7.49
C	—	0.200	—	5.08
D	0.015	0.020	0.39	0.50
E	0.050 BSC		1.27 BSC	
F	0.055	0.065	1.40	1.65
G	0.100 BSC		2.54 BSC	
J	0.008	0.015	0.21	0.38
K	0.125	0.170	3.18	4.31
L	0.300 BSC		7.62 BSC	
M	0°	15°	0°	15°
N	0.020	0.040	0.51	1.01

**P SUFFIX  
PLASTIC PACKAGE  
CASE 648-08  
ISSUE R**

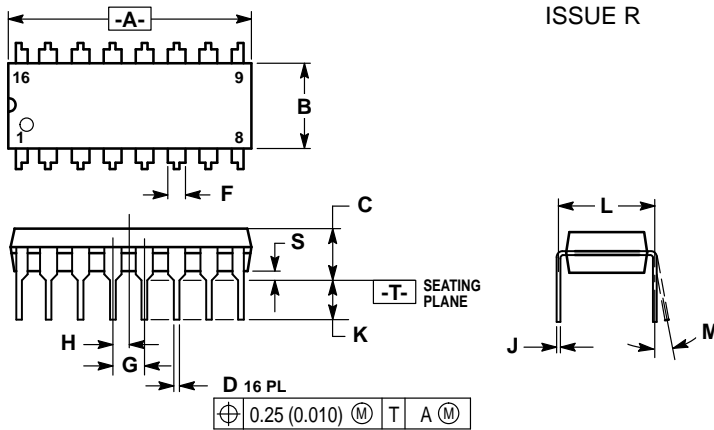

- NOTES:
1. DIMENSIONING AND TOLERANCING PER ANSI Y14.5M, 1982.
  2. CONTROLLING DIMENSION: INCH.
  3. DIMENSION L TO CENTER OF LEADS WHEN FORMED PARALLEL.
  4. DIMENSION B DOES NOT INCLUDE MOLD FLASH.
  5. ROUNDED CORNERS OPTIONAL.

DIM	INCHES		MILLIMETERS	
	MIN	MAX	MIN	MAX
A	0.740	0.770	18.80	19.55
B	0.250	0.270	6.35	6.85
C	0.145	0.175	3.69	4.44
D	0.015	0.021	0.39	0.53
F	0.040	0.070	1.02	1.77
G	0.100 BSC		2.54 BSC	
H	0.050 BSC		1.27 BSC	
J	0.008	0.015	0.21	0.38
K	0.110	0.130	2.80	3.30
L	0.295	0.305	7.50	7.74
M	0°	10°	0°	10°
S	0.020	0.040	0.51	1.01

Motorola reserves the right to make changes without further notice to any products herein. Motorola makes no warranty, representation or guarantee regarding the suitability of its products for any particular purpose, nor does Motorola assume any liability arising out of the application or use of any product or circuit, and specifically disclaims any and all liability, including without limitation consequential or incidental damages. "Typical" parameters which may be provided in Motorola data sheets and/or specifications can and do vary in different applications and actual performance may vary over time. All operating parameters, including "Typicals" must be validated for each customer application by customer's technical experts. Motorola does not convey any license under its patent rights nor the rights of others. Motorola products are not designed, intended, or authorized for use as components in systems intended for surgical implant into the body, or other applications intended to support or sustain life, or for any other application in which the failure of the Motorola product could create a situation where personal injury or death may occur. Should Buyer purchase or use Motorola products for any such unintended or unauthorized application, Buyer shall indemnify and hold Motorola and its officers, employees, subsidiaries, affiliates, and distributors harmless against all claims, costs, damages, and expenses, and reasonable attorney fees arising out of, directly or indirectly, any claim of personal injury or death associated with such unintended or unauthorized use, even if such claim alleges that Motorola was negligent regarding the design or manufacture of the part. Motorola and are registered trademarks of Motorola, Inc. Motorola, Inc. is an Equal Opportunity/Affirmative Action Employer.

**How to reach us:**

**USA/EUROPE/Locations Not Listed:** Motorola Literature Distribution; P.O. Box 5405; Denver, Colorado 80217. 303-675-2140 or 1-800-441-2447

**Mfax™:** RMFAX0@email.sps.mot.com – TOUCHTONE 602-244-6609  
**INTERNET:** http://Design-NET.com

**JAPAN:** Nippon Motorola Ltd.; Tatsumi-SPD-JLDC, 6F Seibu-Butsuryu-Center, 3-14-2 Tatsumi Koto-Ku, Tokyo 135, Japan. 81-3-3521-8315

**ASIA/PACIFIC:** Motorola Semiconductors H.K. Ltd.; 8B Tai Ping Industrial Park, 51 Ting Kok Road, Tai Po, N.T., Hong Kong. 852-26629298