

## LM3146 High Voltage Transistor Array

### General Description

The LM3146 consists of five high voltage general purpose silicon NPN transistors on a common monolithic substrate. Two of the transistors are internally connected to form a differentially-connected pair. The transistors are well suited to a wide variety of applications in low power system in the dc through VHF range. They may be used as discrete transistors in conventional circuits however, in addition, they provide the very significant inherent integrated circuit advantages of close electrical and thermal matching. The LM3146 is supplied in a 14-lead molded dual-in-line package for applications requiring only a limited temperature range.

### Features

- High voltage matched pairs of transistors,  $V_{BE}$  matched  $\pm 5$  mV, input offset current  $2 \mu A$  max at  $I_C = 1$  mA
- Five general purpose monolithic transistors
- Operation from dc to 120 MHz
- Wide operating current range
- Low noise figure 3.2 dB typ at 1 kHz

### Applications

- General use in all types of signal processing systems operating anywhere in the frequency range from dc to VHF
- Custom designed differential amplifiers
- Temperature compensated amplifiers

### Connection Diagram

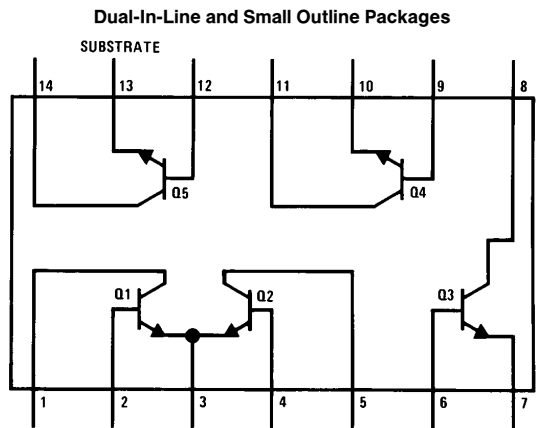

TL/H/7959-1

Top View  
Order Number LM3146M or LM3146N  
See NS Package Number M14A or N14A

## Absolute Maximum Ratings

If Military/Aerospace specified devices are required, please contact the National Semiconductor Sales Office/Distributors for availability and specifications.

	LM3146	Units
Power Dissipation: Each transistor	300	mW
$T_A = 25^\circ\text{C}$ to $55^\circ\text{C}$		
$T_A > 55^\circ\text{C}$	Derate at 6.67	mW/ $^\circ\text{C}$
Power Dissipation: Total Package	500	mW
$T_A = 25^\circ\text{C}$		
$T_A > 25^\circ\text{C}$	Derate at 6.67	mW/ $^\circ\text{C}$
Collector to Emitter Voltage, $V_{CEO}$	30	V
Collector to Base Voltage, $V_{CBO}$	40	V
Collector to Substrate Voltage, $V_{C1O}$ (Note 1)	40	V
Emitter to Base Voltage, $V_{EBO}$ (Note 2)	5	V
Collector to Current, $I_C$	50	mA
Operating Temperature Range	-40 to +85	$^\circ\text{C}$
Storage Temperature Range	-65 to +150	$^\circ\text{C}$

### Soldering Information

Dual-In-Line Package	
Soldering (10 seconds)	260 $^\circ\text{C}$
Small Outline Package	
Vapor Phase (60 seconds)	215 $^\circ\text{C}$
Infrared (15 seconds)	220 $^\circ\text{C}$

See AN-450 "Surface Mounting Methods and Their Effect on Product Reliability" for other methods of soldering surface mount devices.

## DC Electrical Characteristics $T_A = 25^\circ\text{C}$

Symbol	Parameter	Conditions	Limits			Units
			Min	Typ	Max	
$V_{(BR)CBO}$	Collector to Base Breakdown Voltage	$I_C = 10 \mu\text{A}$ , $I_E = 0$	40	72		V
$V_{(BR)CEO}$	Collector to Emitter Breakdown Voltage	$I_C = 1 \text{mA}$ , $I_B = 0$	30	56		V
$V_{(BR)C1O}$	Collector to Substrate Breakdown Voltage	$I_{C1} = 10 \mu\text{A}$ , $I_B = 0$ , $I_E = 0$	40	72		V
$V_{(BR)EBO}$	Emitter to Base Breakdown Voltage (Note 2)	$I_C = 0$ , $I_E = 10 \mu\text{A}$	5	7		V
$I_{CBO}$	Collector Cutoff Current	$V_{CB} = 10\text{V}$ , $I_E = 0$		0.002	100	nA
$I_{CEO}$	Collector Cutoff Current	$V_{CE} = 10\text{V}$ , $I_B = 0$		(Note 3)	5	$\mu\text{A}$
$h_{FE}$	Static Forward Current Transfer Ratio (Static Beta)	$I_C = 10 \text{mA}$ , $V_{CE} = 5\text{V}$ $I_C = 1 \text{mA}$ , $V_{CE} = 5\text{V}$ $I_C = 10 \mu\text{A}$ , $V_{CE} = 5\text{V}$	30	85 100 90		
$I_{B1} - I_{B2}$	Input Offset Current for Matched Pair Q1 and Q2	$I_{C1} = I_{C2} = 1 \text{mA}$ , $V_{CE} = 5\text{V}$		0.3	2	$\mu\text{A}$
$V_{BE}$	Base to Emitter Voltage	$I_C = 1 \text{mA}$ , $V_{CE} = 3\text{V}$	0.63	0.73	0.83	V
$V_{BE1} - V_{BE2}$	Magnitude of Input Offset Voltage for Differential Pair	$V_{CE} = 5\text{V}$ , $I_E = 1 \text{mA}$		0.48	5	mV
$\Delta V_{BE}/\Delta T$	Temperature Coefficient of Base to Emitter Voltage	$V_{CE} = 5\text{V}$ , $I_E = 1 \text{mA}$		-1.9		mV/ $^\circ\text{C}$
$V_{CE(SAT)}$	Collector to Emitter Saturation Voltage	$I_C = 10 \text{mA}$ , $I_B = 1 \text{mA}$		0.33		V
$\Delta V_{I0}/\Delta T$	Temperature Coefficient of Input Offset Voltage	$I_C = 1 \text{mA}$ , $V_{CE} = 5\text{V}$		1.1		$\mu\text{V}/^\circ\text{C}$

**Note 1:** The collector of each transistor is isolated from the substrate by an integral diode. The substrate must be connected to a voltage which is more negative than any collector voltage in order to maintain isolation between transistors and provide normal transistor action. To avoid undesired coupling between transistors, the substrate terminal should be maintained at either dc or signal (ac) ground. A suitable bypass capacitor can be used to establish a signal ground.

**Note 2:** If the transistors are forced into zener breakdown ( $V_{(BR)EBO}$ ), degradation of forward transfer current ratio ( $h_{FE}$ ) can occur.

**Note 3:** See curve.

## AC Electrical Characteristics

Symbol	Parameter	Conditions	Limits			Units
			Min	Typ	Max	
NF	Low Frequency Noise Figure	$f = 1 \text{ kHz}, V_{CE} = 5V,$ $I_C = 100 \mu A, R_S = 1 \text{ k}\Omega$		3.25		dB
$f_T$	Gain Bandwidth Product	$V_{CE} = 5V, I_C = 3 \text{ mA}$	300	500		MHz
$C_{EB}$	Emitter to Base Capacitance	$V_{EB} = 5V, I_E = 0$		0.70		pF
$C_{CB}$	Collector to Base Capacitance	$V_{CB} = 5V, I_C = 0$		0.37		pF
$C_{CI}$	Collector to Substrate Capacitance	$V_{CI} = 5V, I_C = 0$		2.2		pF

### Low Frequency, Small Signal Equivalent Circuit Characteristics

$h_{fe}$	Forward Current Transfer Ratio	$f = 1 \text{ kHz}, V_{CE} = 3V, I_C = 1 \text{ mA}$		100		
$h_{ie}$	Short Circuit Input Impedance	$f = 1 \text{ kHz}, V_{CE} = 3V, I_C = 1 \text{ mA}$		3.5		k $\Omega$
$h_{oe}$	Open Circuit Output Impedance	$f = 1 \text{ kHz}, V_{CE} = 3V, I_C = 1 \text{ mA}$		15.6		$\mu\text{mho}$
$h_{re}$	Open Circuit Reverse Voltage Transfer Ratio	$f = 1 \text{ kHz}, V_{CE} = 3V,$ $I_C = 1 \text{ mA}$		$1.8 \times 10^{-4}$		

### Admittance Characteristics

$Y_{fe}$	Forward Transfer Admittance	$f = 1 \text{ MHz}, V_{CE} = 3V, I_C = 1 \text{ mA}$		$31 - j 1.5$		mmho
$Y_{ie}$	Input Admittance	$f = 1 \text{ MHz}, V_{CE} = 3V, I_C = 1 \text{ mA}$		$0.3 + j 0.04$		mmho
$Y_{oe}$	Output Admittance	$f = 1 \text{ MHz}, V_{CE} = 3V, I_C = 1 \text{ mA}$		$0.001 + j 0.03$		mmho
$Y_{re}$	Reverse Transfer Admittance	$f = 1 \text{ MHz}, V_{CE} = 3V, I_C = 1 \text{ mA}$		(Note 3)		mmho

**Note 1:** The collector of each transistor is isolated from the substrate by an integral diode. The substrate must be connected to a voltage which is more negative than any collector voltage in order to maintain isolation between transistors and provide normal transistor action. To avoid undesired coupling between transistors, the substrate terminal should be maintained at either dc or signal (ac) ground. A suitable bypass capacitor can be used to establish a signal ground.

**Note 2:** If the transistors are forced into zener breakdown ( $V_{(BR)EBO}$ ), degradation of forward transfer current ratio ( $h_{FE}$ ) can occur.

**Note 3:** See curve.

# Typical Performance Characteristics

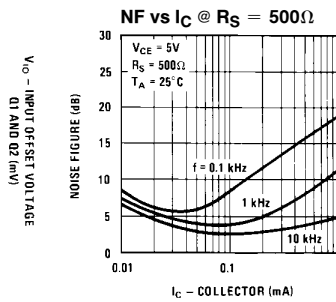
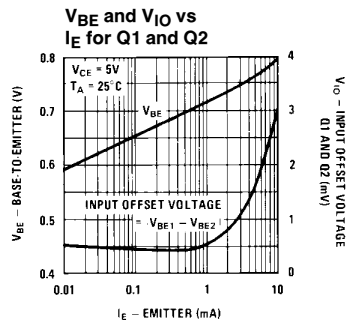
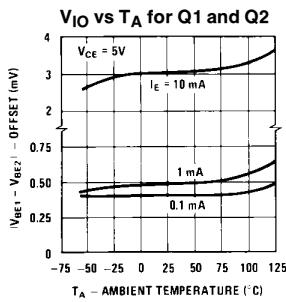
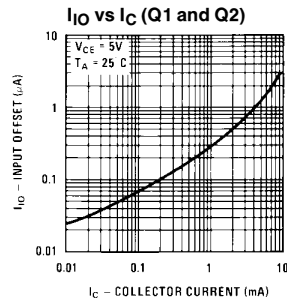
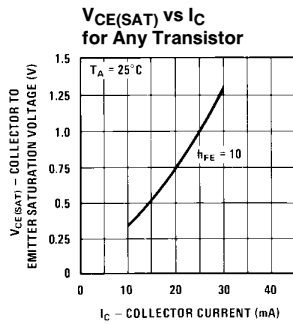
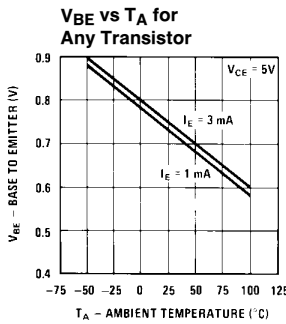
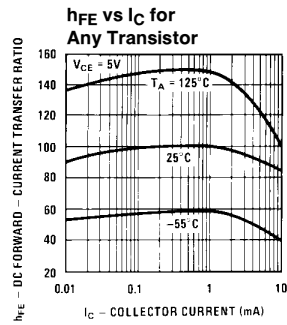
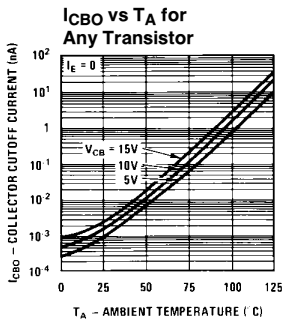
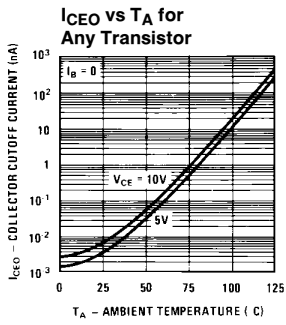

TL/H/7959-2

# Typical Performance Characteristics (Continued)

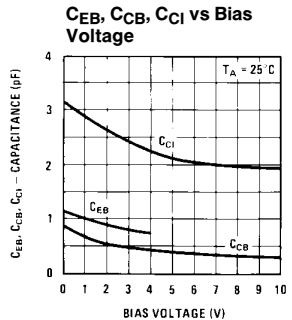
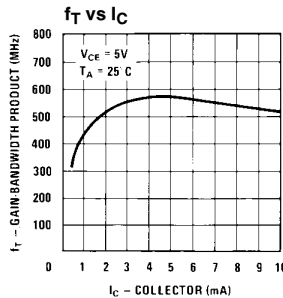
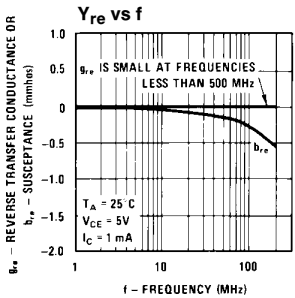
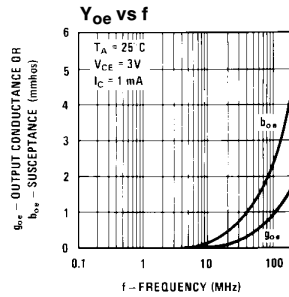
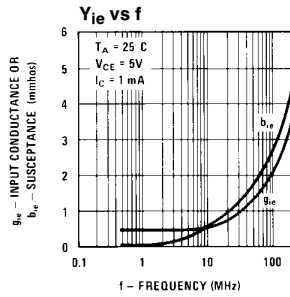
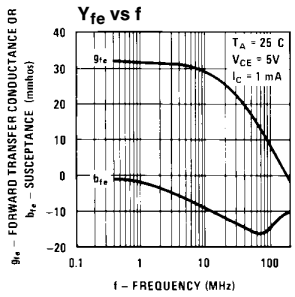
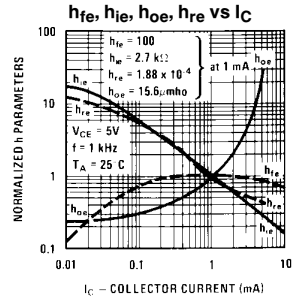
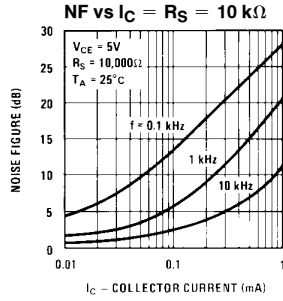
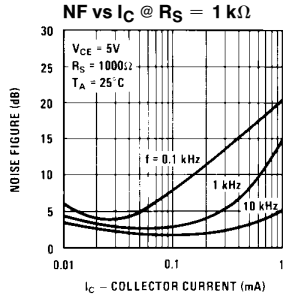

TL/H/7959-3

**Physical Dimensions** inches (millimeters)

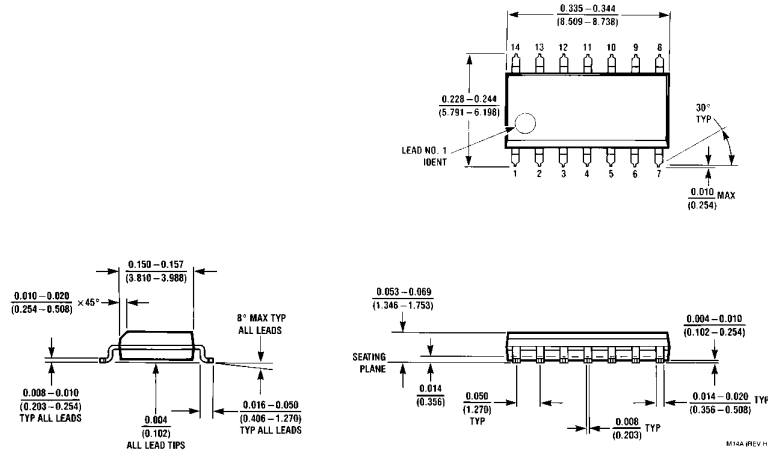

**SO Package (M)**  
**Order Number LM3146M**  
**NS Package Number M14A**

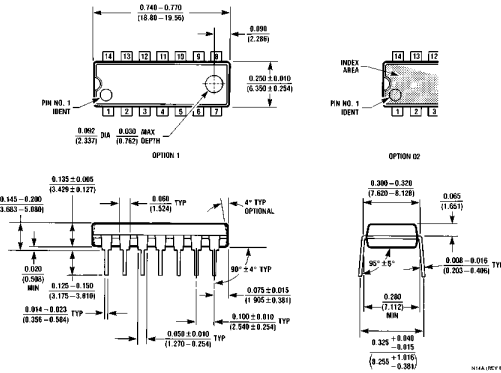

**Molded Dual-In-Line Package (N)**  
**Order Number LM3146N**  
**NS Package Number N14A**

**LIFE SUPPORT POLICY**

NATIONAL'S PRODUCTS ARE NOT AUTHORIZED FOR USE AS CRITICAL COMPONENTS IN LIFE SUPPORT DEVICES OR SYSTEMS WITHOUT THE EXPRESS WRITTEN APPROVAL OF THE PRESIDENT OF NATIONAL SEMICONDUCTOR CORPORATION. As used herein:

1. Life support devices or systems are devices or systems which, (a) are intended for surgical implant into the body, or (b) support or sustain life, and whose failure to perform, when properly used in accordance with instructions for use provided in the labeling, can be reasonably expected to result in a significant injury to the user.
2. A critical component is any component of a life support device or system whose failure to perform can be reasonably expected to cause the failure of the life support device or system, or to affect its safety or effectiveness.

 <p><b>National Semiconductor Corporation</b>          1111 West Bardin Road          Arlington, TX 76017          Tel: 1(800) 272-9959          Fax: 1(800) 737-7018</p>	<p><b>National Semiconductor Europe</b>          Fax: (+49) 0-180-530 85 86          Email: cnjwge@tevm2.nsc.com          Deutsch Tel: (+49) 0-180-530 85 85          English Tel: (+49) 0-180-532 78 32          Français Tel: (+49) 0-180-532 93 58          Italiano Tel: (+49) 0-180-534 16 80</p>	<p><b>National Semiconductor Hong Kong Ltd.</b>          19th Floor, Straight Block,          Ocean Centre, 5 Canton Rd.          Tsimshatsui, Kowloon          Hong Kong          Tel: (852) 2737-1600          Fax: (852) 2736-9960</p>	<p><b>National Semiconductor Japan Ltd.</b>          Tel: 81-043-299-2309          Fax: 81-043-299-2408</p>
------------------------------------------------------------------------------------------------------------------------------------------------------------------------------------------------------------------------------------------------------------------------------	--------------------------------------------------------------------------------------------------------------------------------------------------------------------------------------------------------------------------------------------------------------------------------------------------------------------------------	-------------------------------------------------------------------------------------------------------------------------------------------------------------------------------------------------------------------------------------------------------------------	---------------------------------------------------------------------------------------------------------------------

National does not assume any responsibility for use of any circuitry described, no circuit patent licenses are implied and National reserves the right at any time without notice to change said circuitry and specifications.