



SANYO Semiconductors

DATA SHEET

LA1805 — Monolithic Linear IC AM / FM-IF / MPX Tuner System for Radio-Cassette Recorders, Music Centers

Overview

The LA1805 is a characteristics-improved version of the LA1810, with the same pin assignment and package as those of the LA1810. Improvements are made on the following point:

- Separation (35dB→48dB) and its dependence on freerunning frequency (Sep - f_F Characteristic on page 5).
- FM main distortion (0.8%→0.45%).
- AM detection output (approximately 5dB increased).

The constants on five external parts are changed as shown on page 11.

Functions

- FM-IF: IF amp, quadrature detector, soft muting, tuning indicator.
- MPX: PLL stereo decoder, stereo indicator, forced monaural, VCO stop.
- AM: RF amp, MIX, OSC (with ALC), IF amp, detector, AGC, tuning indicator.

Features

- FM / AM / MPX functions contained on a single chip.
- Minimum number of external parts required.
- On-chip FM muting function.
- High sensitivity.
- Less carrier leak of MPX.

Specifications

Maximum Ratings at $T_a=25^\circ\text{C}$, See specified Test Circuit.

Parameter	Symbol	Conditions	Ratings	Unit
Maximum supply voltage	$V_{CC \text{ max}}$	Pins 3, 7, 8, 11, 20, 21	9	V
Maximum supply current	$I_{CC \text{ max}}$	Pins 3+20+21	50	mA
Flow-in current (Indicator drive current)	I_{LED}	Pins 7, 8	20	mA
Flow-out current	I_{23}	Pin 23	0.1	mA
Allowable power dissipation	$P_d \text{ max}$	$T_a \leq 70^\circ\text{C}$	500	mW
Operating temperature	T_{opr}		-20 to +70	$^\circ\text{C}$
Storage temperature	T_{stg}		-40 to +125	$^\circ\text{C}$

■ Any and all SANYO products described or contained herein do not have specifications that can handle applications that require extremely high levels of reliability, such as life-support systems, aircraft's control systems, or other applications whose failure can be reasonably expected to result in serious physical and/or material damage. Consult with your SANYO representative nearest you before using any SANYO products described or contained herein in such applications.

■ SANYO assumes no responsibility for equipment failures that result from using products at values that exceed, even momentarily, rated values (such as maximum ratings, operating condition ranges, or other parameters) listed in products specifications of any and all SANYO products described or contained herein.

SANYO Electric Co., Ltd. Semiconductor Company

TOKYO OFFICE Tokyo Bldg., 1-10, 1 Chome, Ueno, Taito-ku, TOKYO, 110-8534 JAPAN

LA1805

Operating Conditions at Ta=25°C

Parameter	Symbol	Conditions	Ratings	Unit
Recommended operating voltage	VCC		4.5	V
Operating voltage range	VCC op		3.0 to 8.0	V

Note: The FM output level forms an N curve (LA1805) and an S curve (LA1806).

LA1805: N curve (for US band)

LA1806: S curve (for Japanese band). Your desired output level can be set by varying the output resistance.

Operating Characteristics at Ta=25°C, VCC=4.5V, See specified Test Circuit.

Parameter	Symbol	Conditions	Ratings			Unit
			min	typ	max	
[FM characteristics (Mono): fc=10.7MHz, fm=1kHz]						
Quiescent current	ICCO	No input		13	20	mA
-3dB sensitivity	-3dBLS.	Referenced to VIN=100dBμ, 100%, down 3dB		28	35	dBμ
Demodulation output	VO	VIN=100dBμ, 100% mod.	140	205	280	mV
Channel balance	C.B.	VIN=100dBμ, 100% mod.	0	0	1.5	dB
Total harmonic distortion	THD	VIN=100dBμ, 100% mod.		0.45	1.2	%
Signal to noise ratio	S / N	VIN=100dBμ, 100% mod.	70	80		dB
LED ON sensitivity	VLED	IL=1mA	23	33	43	dBμ
[FM characteristics (Stereo): fc=10.7MHz, fm=1kHz, L+R=90%, pilot=10%, VIN=100dBμ]						
Separation	Sep		32	48		dB
Stereo distortion	THD (Main)			0.45	1.2	%
LED ON level	VLED-on		2.4	3.9	5.4	%
LED OFF level	VLED-off			2.7		%
[AM characteristics: fc=1000kHz, fm=1kHz]						
Quiescent current	ICCO	No input		9.5	14.5	mA
Demodulation output	VO1	VIN=23dBμ, 30% mod.	27	50	90	mV
	VO2	VIN=80dBμ, 30% mod.	70	113	173	mV
Signal to noise ratio	S / N1	VIN=23dBμ, 30% mod.	17	21		dB
	S / N2	VIN=80dBμ, 30% mod.	50	55		dB
Total harmonic distortion	THD1	VIN=80dBμ, 30% mod.		0.45	1.2	%
	THD2	VIN=100dBμ, 30% mod.		0.6	1.5	%
LED on sensitivity	VLED	IL=1mA	16	24	32	dBμ

Note: Be fully careful of dielectric breakdown.

Package Dimensions

unit : mm

3067B

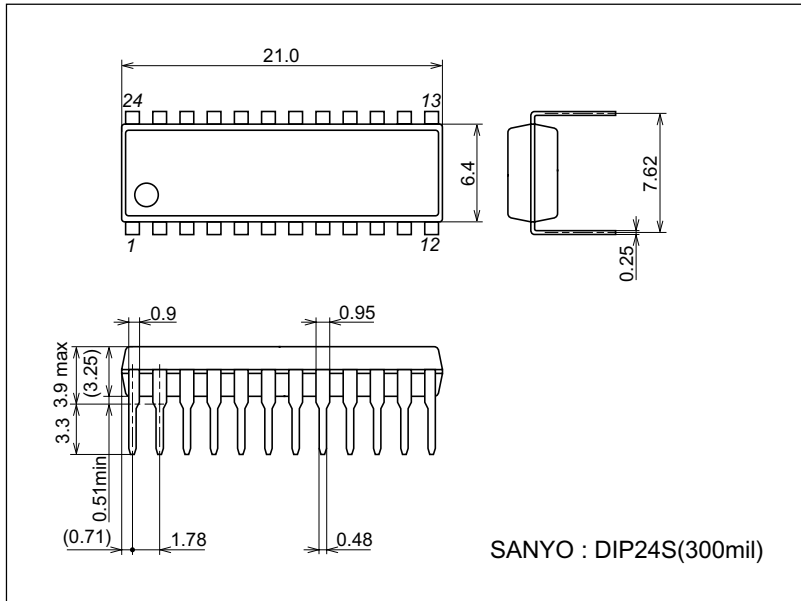

LA1805

Equivalent Circuit Block Diagram

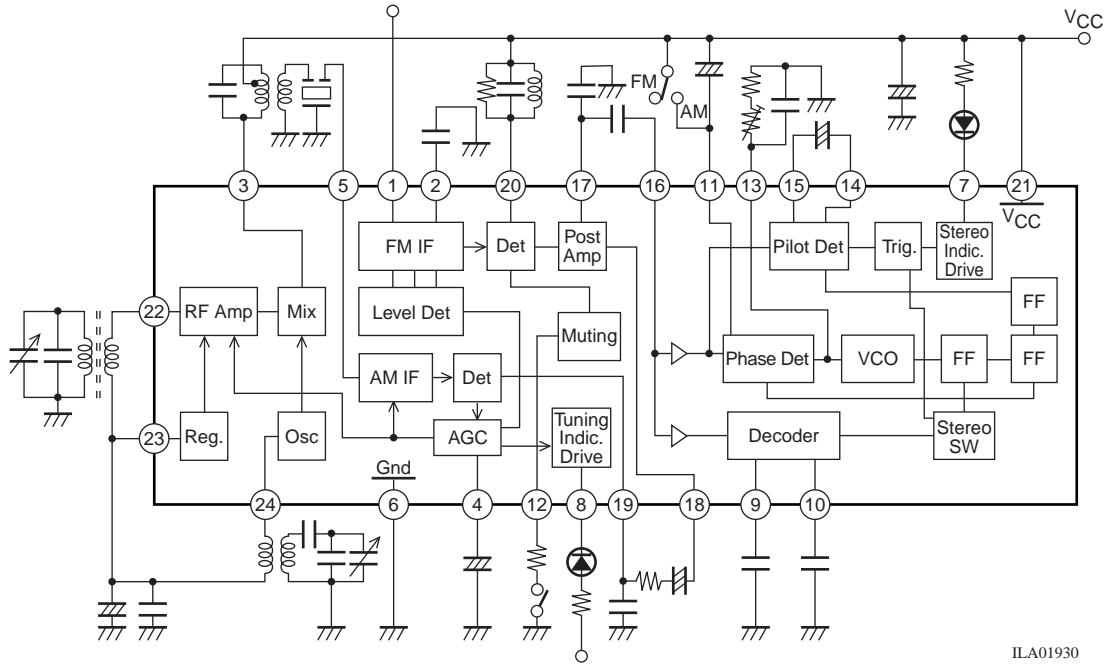

ILA01930

Test Circuit

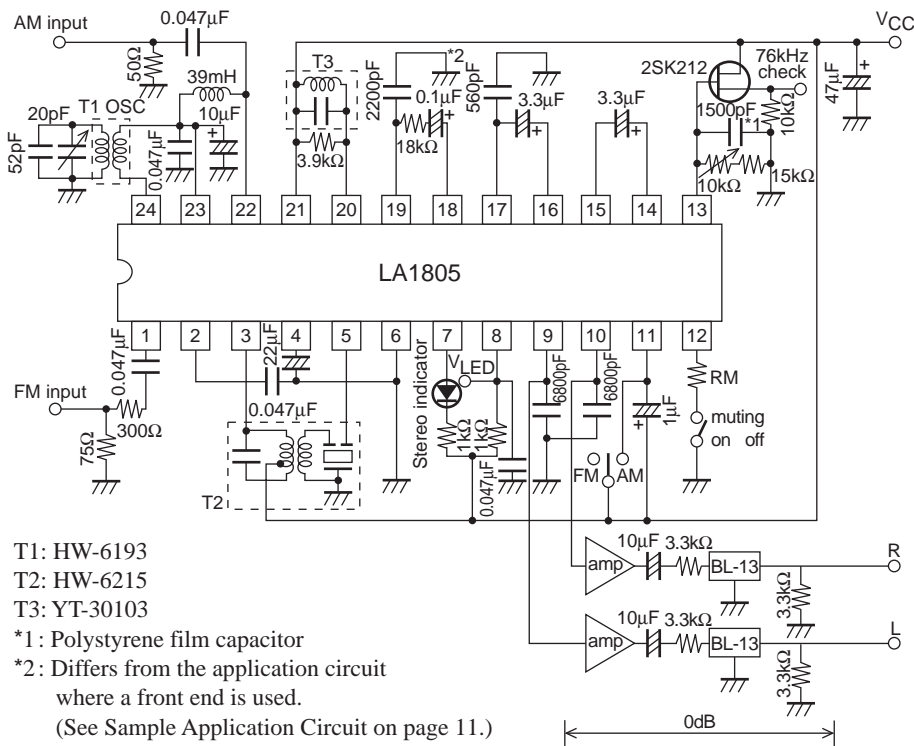

T1: HW-6193

T2: HW-6215

T3: YT-30103

*1: Polystyrene film capacitor

*2: Differs from the application circuit where a front end is used.

(See Sample Application Circuit on page 11.)

ILA01931

How to use the LA1805

1. Forced monaural mode.

Figures 1 and 2 show how to cause the forced monaural mode to be entered.

- (1) Connect pin 14 to VCC through a resistor of 100kΩ. (Turn ON the SW1 in Figure 1.)
- (2) Connect pin 15 to GND through a resistor of 47kΩ. (Turn ON the SW2 in Figure 2.)

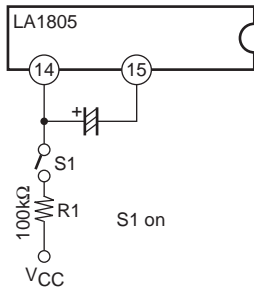

ILA01932

Figure 1 Forced Monaural Mode Setting Method

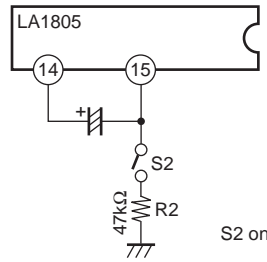

ILA01933

Figure 2 Forced Monaural Mode Setting Method

Either above-mentioned (1) or (2) causes the forced monaural mode to be entered. In this case, the VCO does not stop operating. If the resistance of R1 and R2 are decreased, internal bias will vary when the S1 or S2 is turned ON. This data is shown in Figure 3.

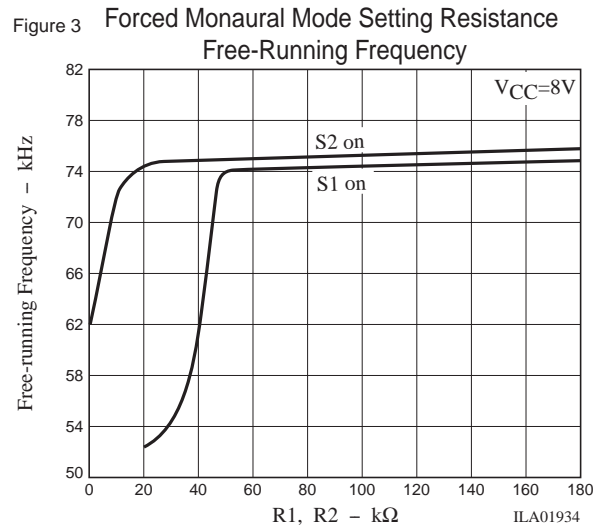

ILA01934

2. VCO Stop

The VCO is so designed as to stop automatically at the AM mode.

(when pin 11 and pin 21 are at the same potential)
 There is no pin available for stopping the VCO at the FM mode. However, the method shown right can be used to stop the VCO at the FM mode, causing the forced monaural mode to be entered.

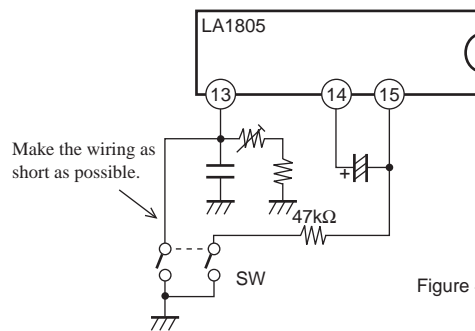

Figure 4

ILA01935

3. Free-running frequency measurement and adjustment

Either of the following two methods is used to measure the free-running frequency.

- (1) Connect pin 13 to a frequency counter through the high input impedance amplifier.
- (2) Connect the connection point of the semifixed resistor connected to pin 13 and the fixed resistor to a frequency counter through the resistor of 240kΩ or greater.

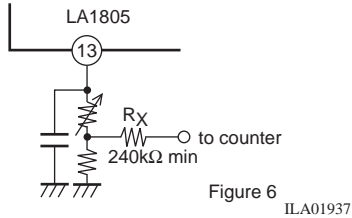
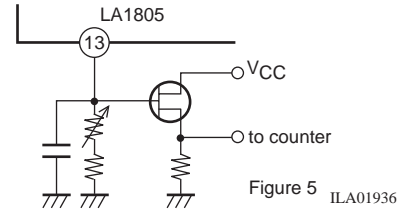

How the error changes with the resistor value is shown in Figure 7.

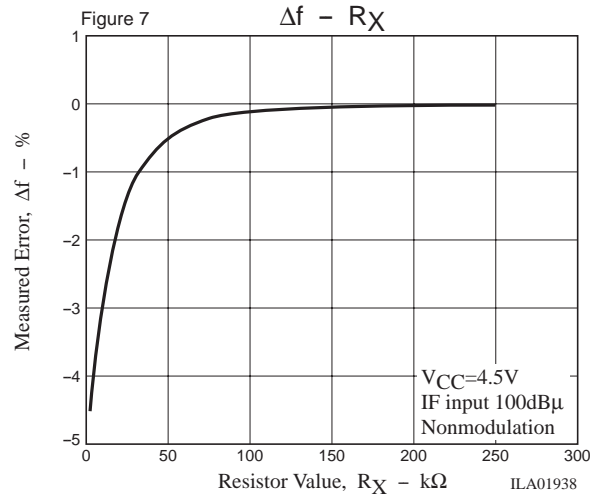

• When setting the free-running frequency, the following must be noted.

Apply a 10.7MHz 100dBμ nonmodulation carrier as IF input signal and set to 76kHz±50Hz with the tuning indicator lighted.

4. Separation setting capacitor C_s

The separation characteristic for the LA1805 alone (IF input) differs from that for the antenna input with a front end. This difference is caused by the characteristics of the front end and ceramic filter. Shown right is how the separation characteristic changes with the separation setting capacitor value when the LA1186N is used as front end. Referring to this separation characteristic, choose the optimum separation for your set model.

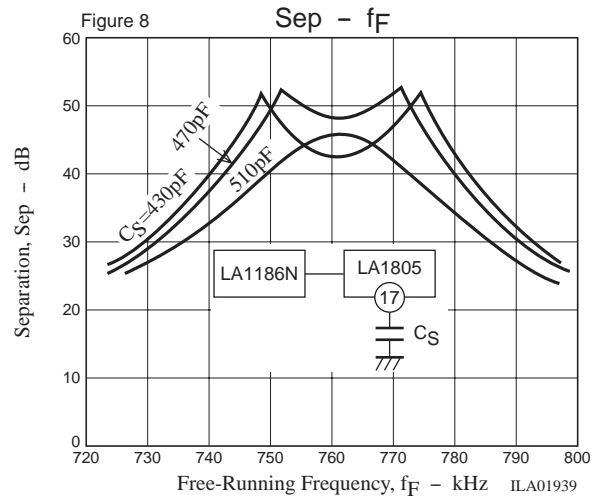

5. FM muting pin

The external resistor connected to pin 12 can be used to vary the muting level (Figure 9). The abnormal sound at the time of side peak reception at the FM mode can be reduced by weak signal muting.

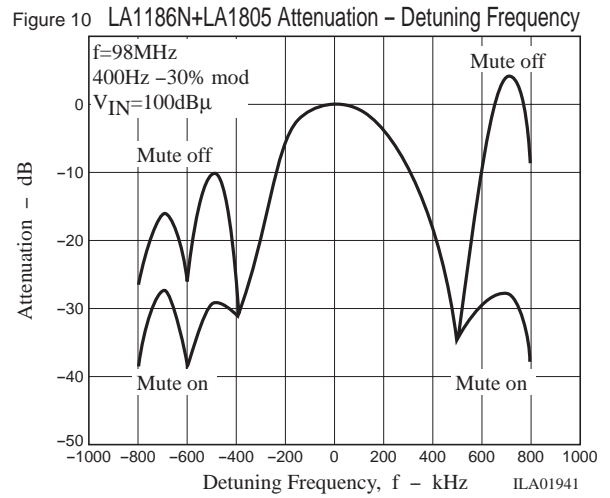
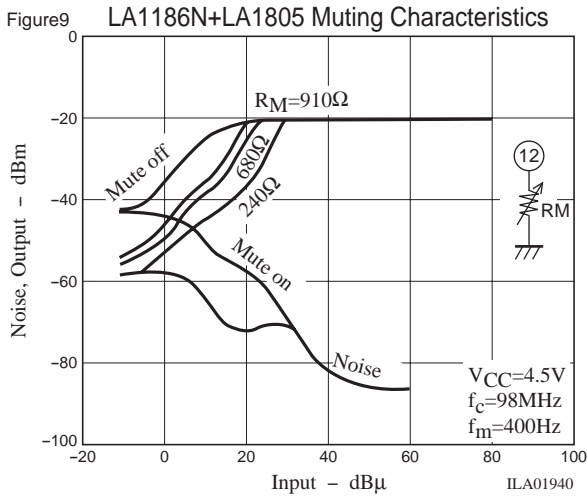

6. The following method can be used to change the LED ON sensitivity at the FM mode (Figure 11). The data on the LED ON sensitivity setting resistance and LED ON sensitivity is shown in Figure 12.

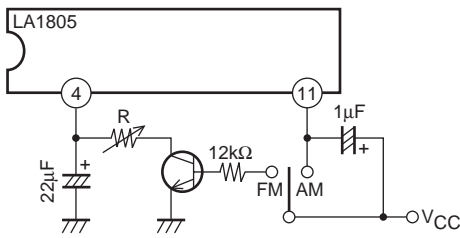
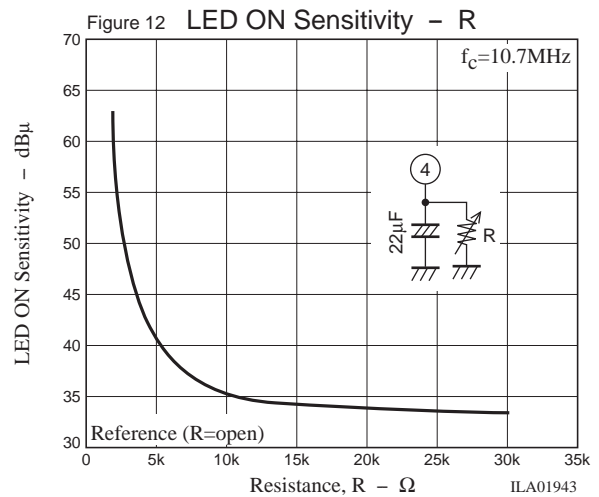

Figure 11 Method to Change the LED ON Sensitivity at the FM Mode ILA01942



7. AM-FM selection

The FM mode is entered with pin 11 open as shown in Figure 13. When pin 11 and pin 21 are made to be at the same potential in terms of DC, the AM mode is entered. It should be noted that the dynamic range is narrowed whether the potential at pin 11 is lower or higher than that at pin 21.

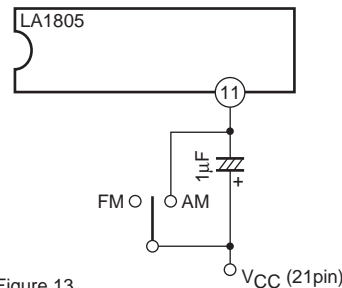
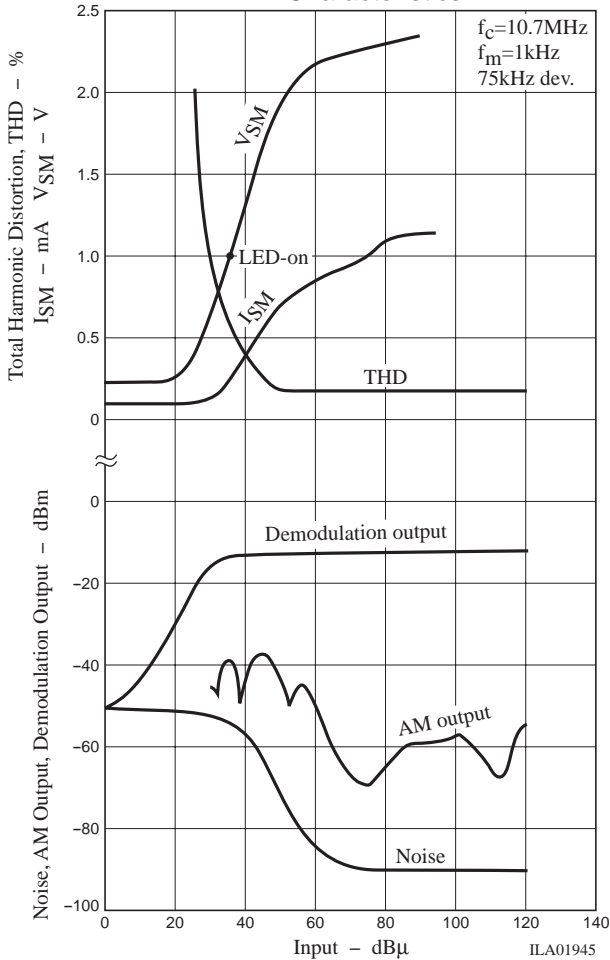

Figure 13 ILA01944

8. If a noise appears in the detection output when the tuning LED goes ON at the AM mode, connect a capacitor across pin 8 and GND to eliminate the noise.

FM Characteristics



AM Characteristics

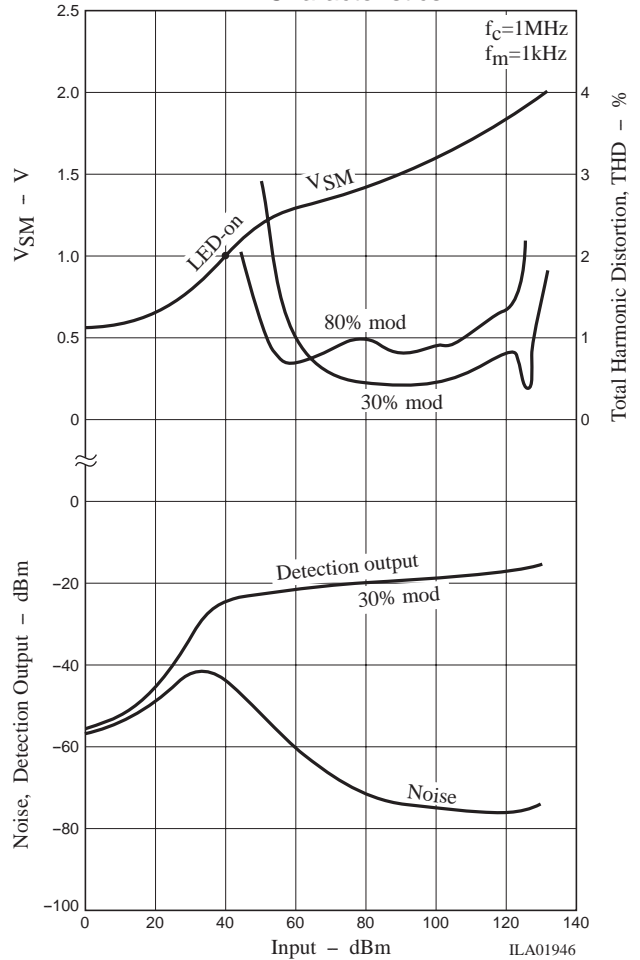

Selectivity Characteristic

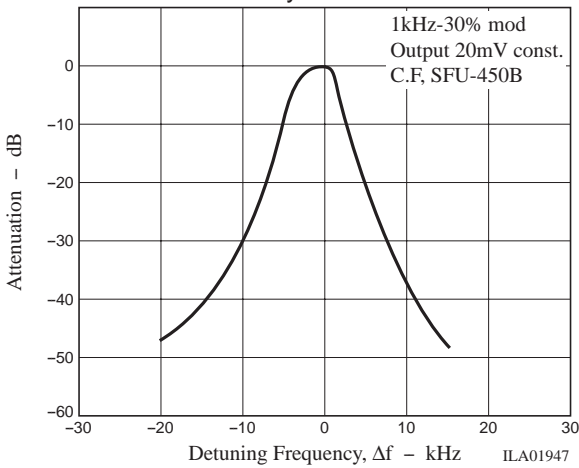

Fidelity Characteristics

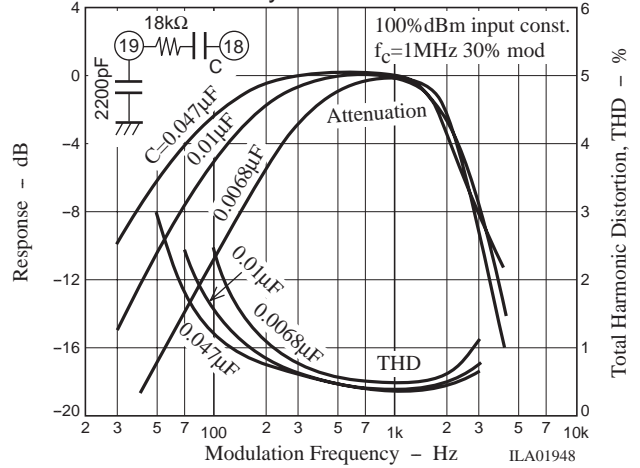

Whistle Characteristics

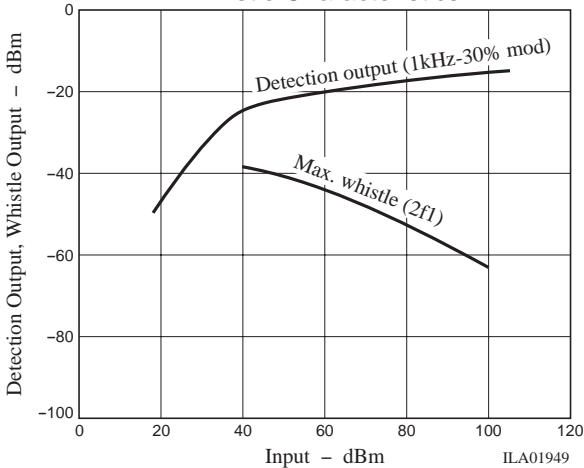

MW Reception Characteristics

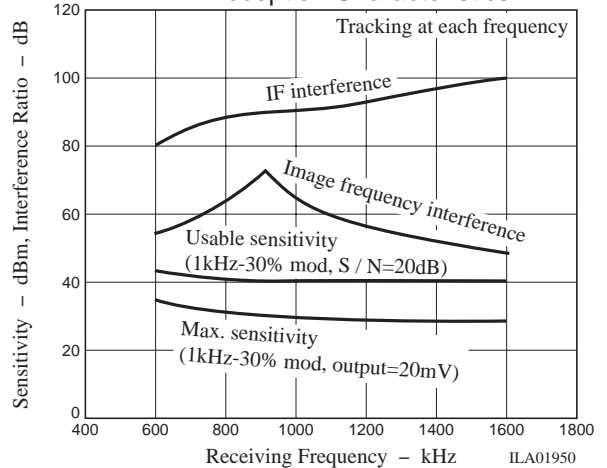

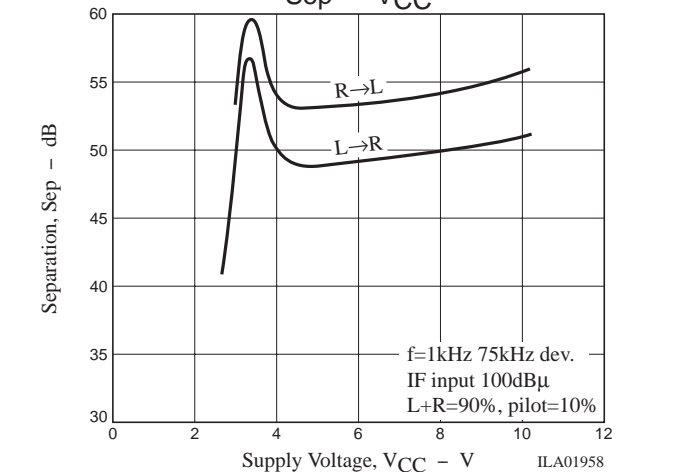
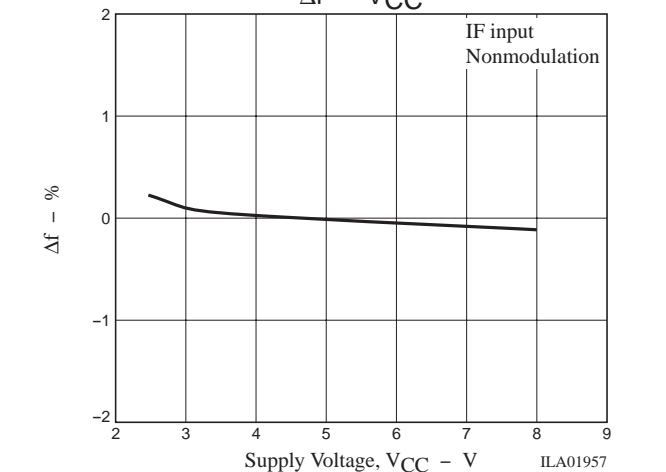
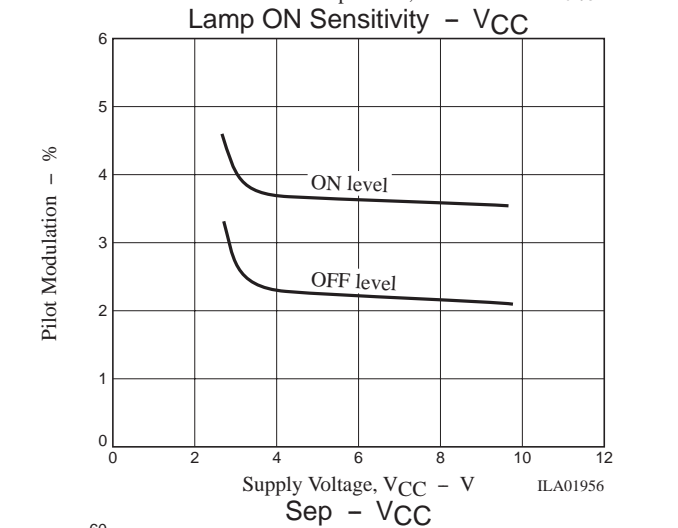
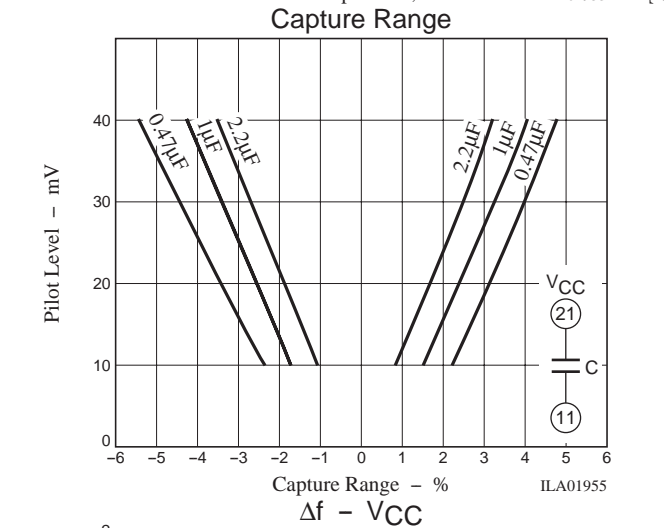
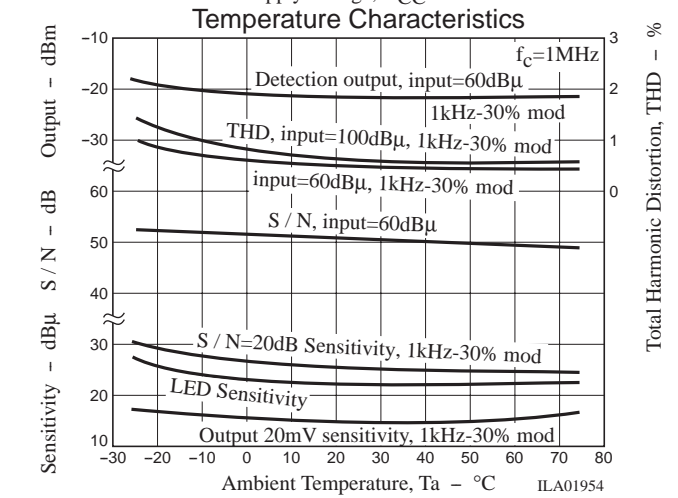
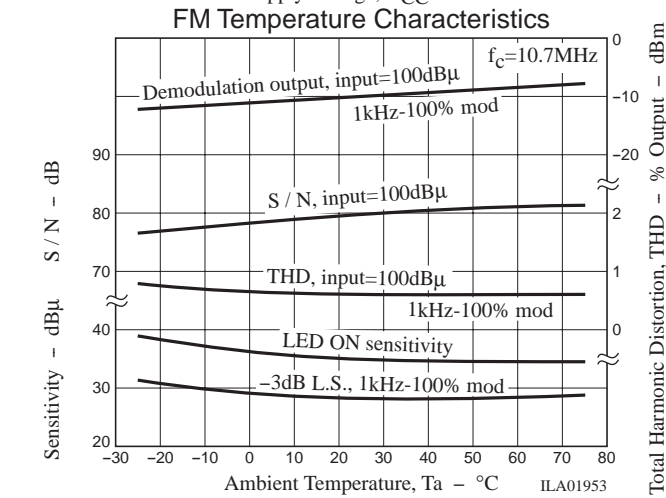
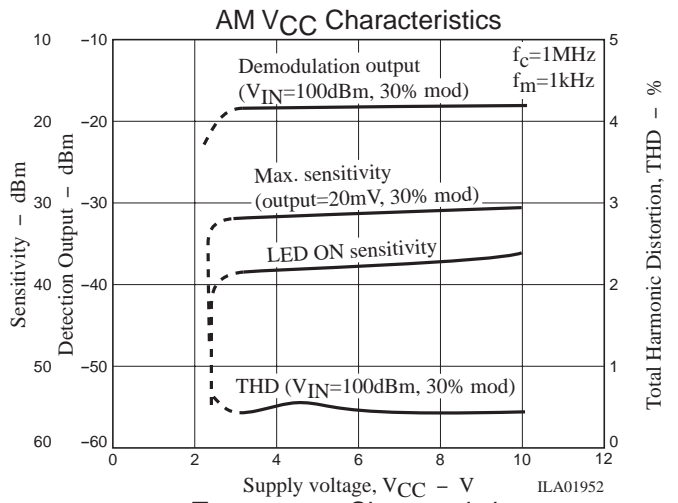
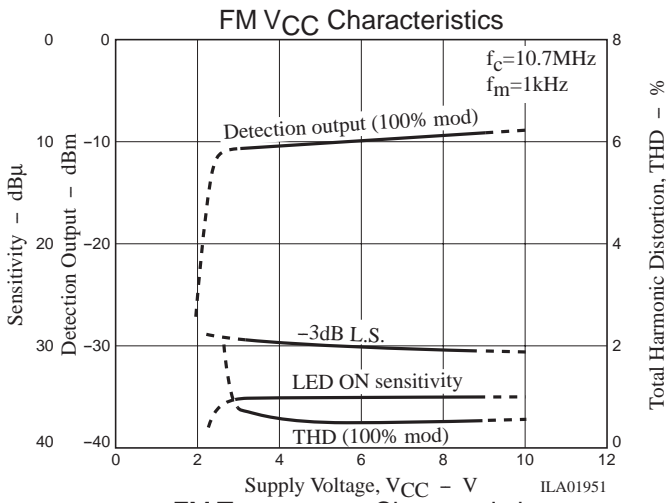

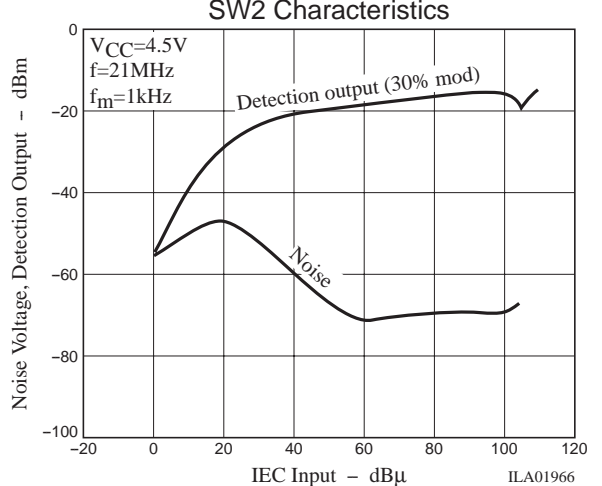
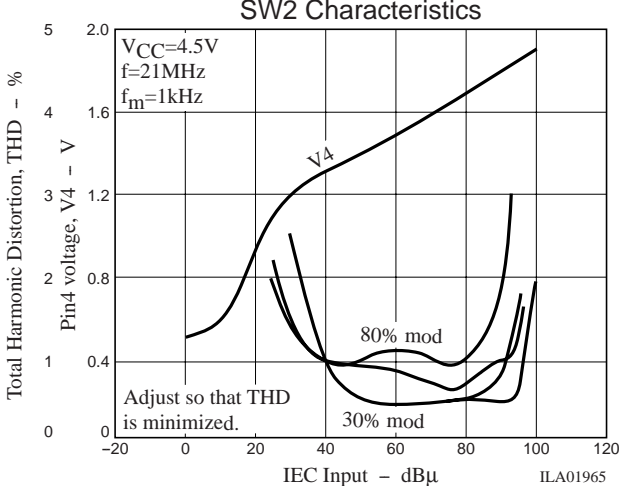
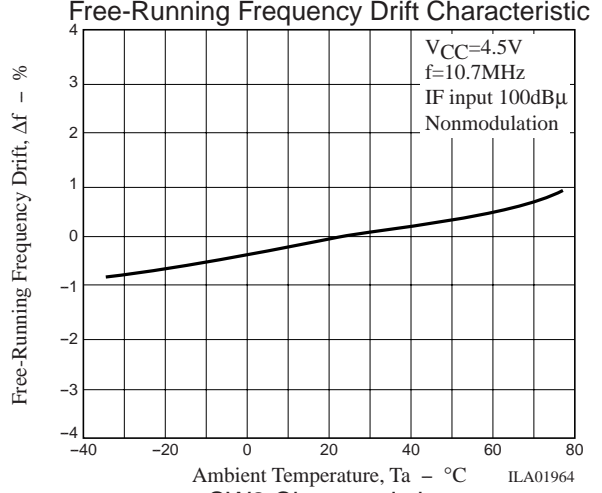
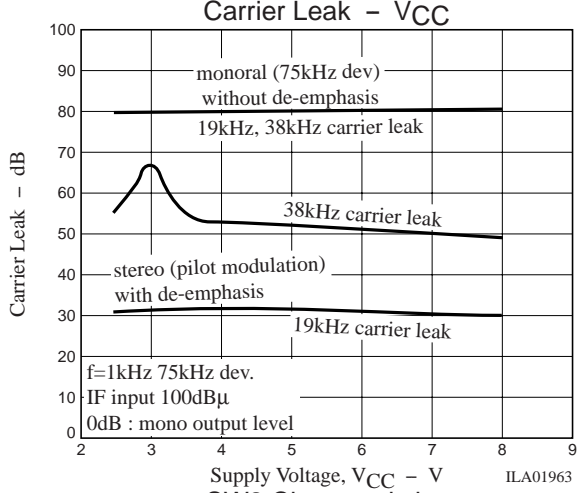
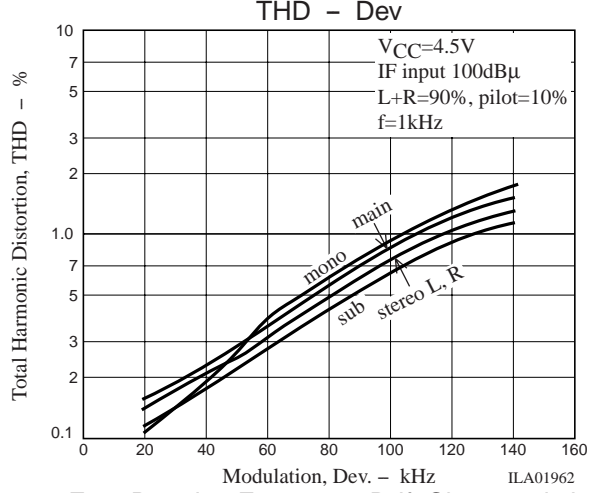
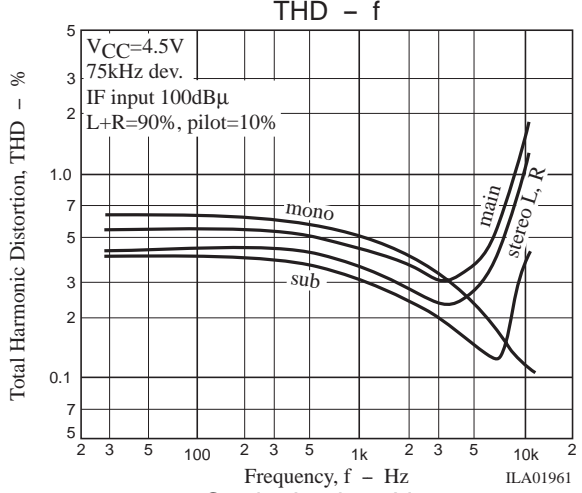
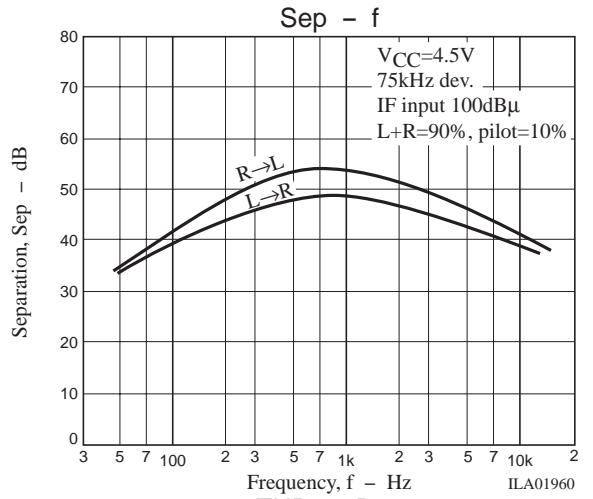
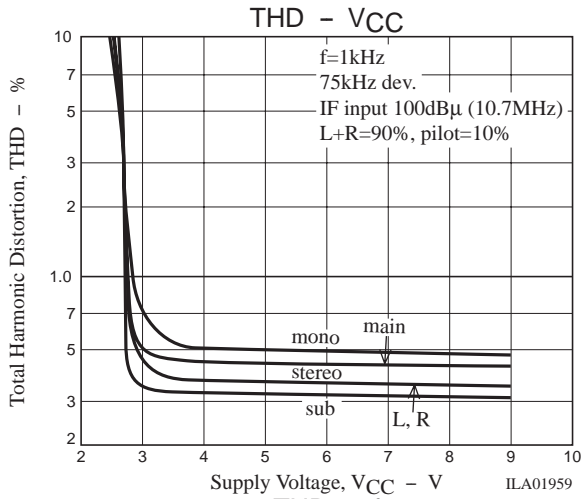

LA1805

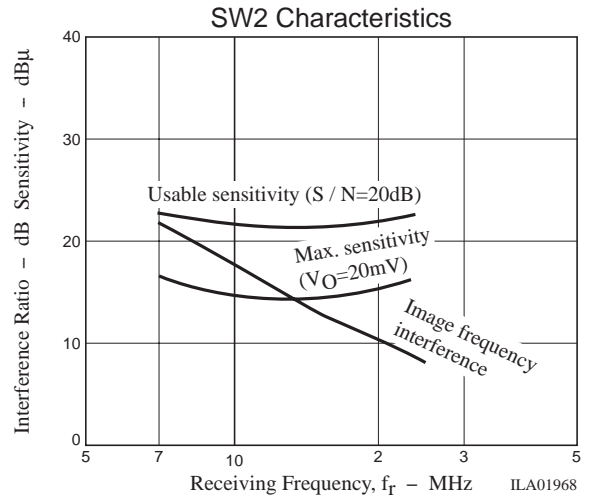
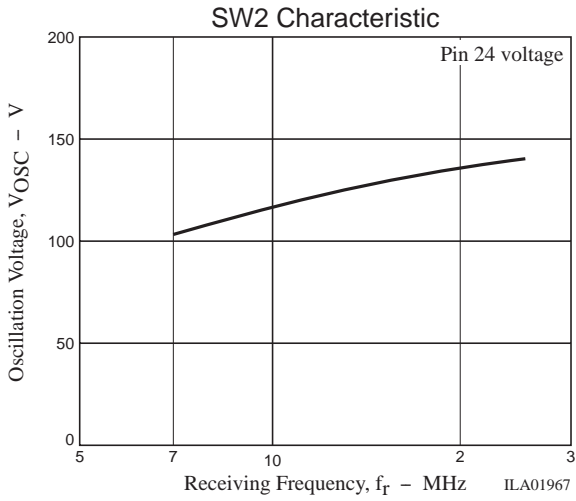

SW Band Test Circuit

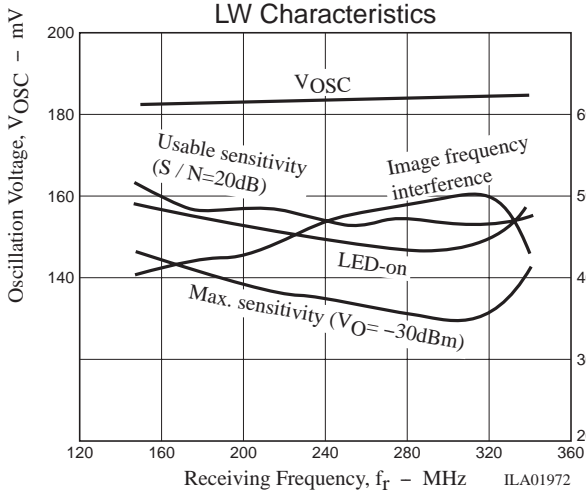
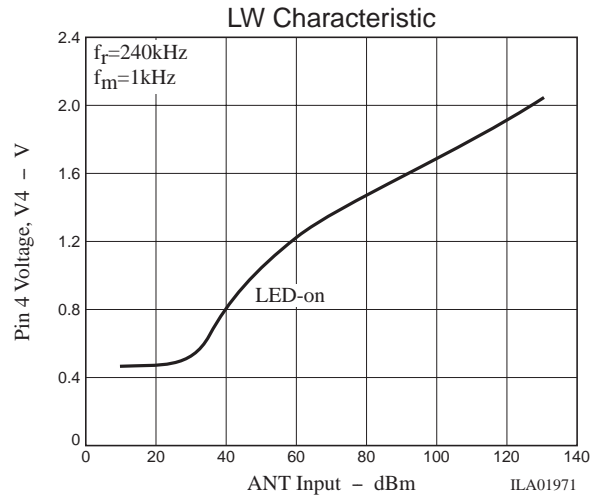
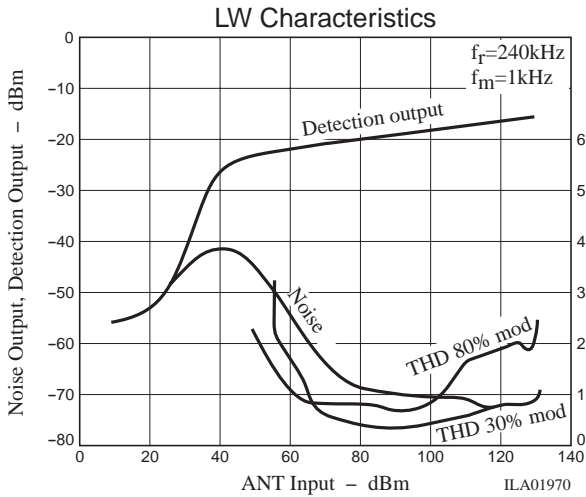
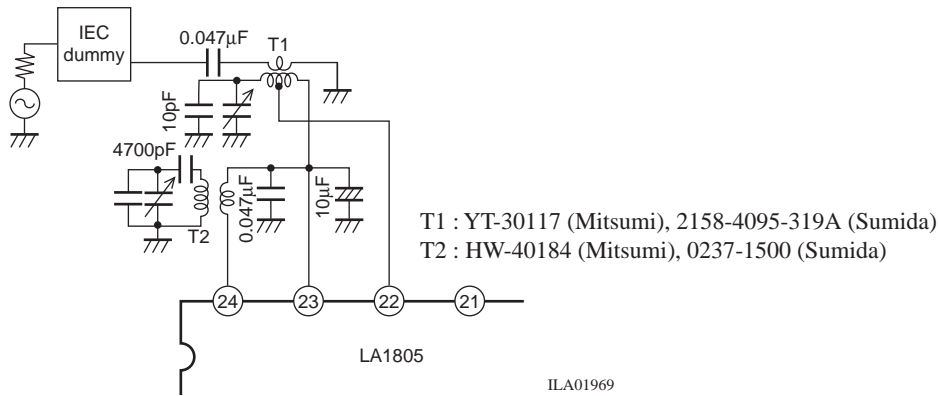

LW Band Test Circuit

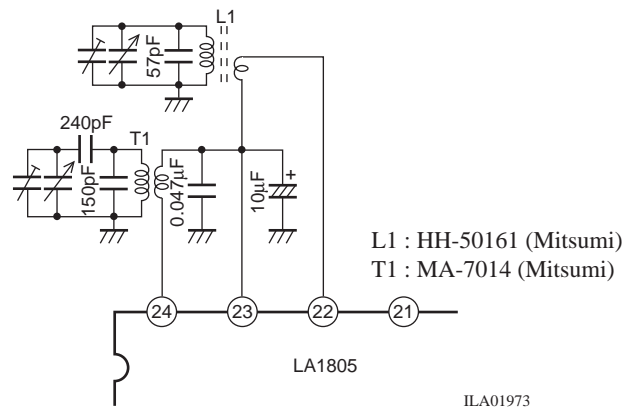

LA1805

Sample Application Circuit: LA1186N+LA1805 FM/MW

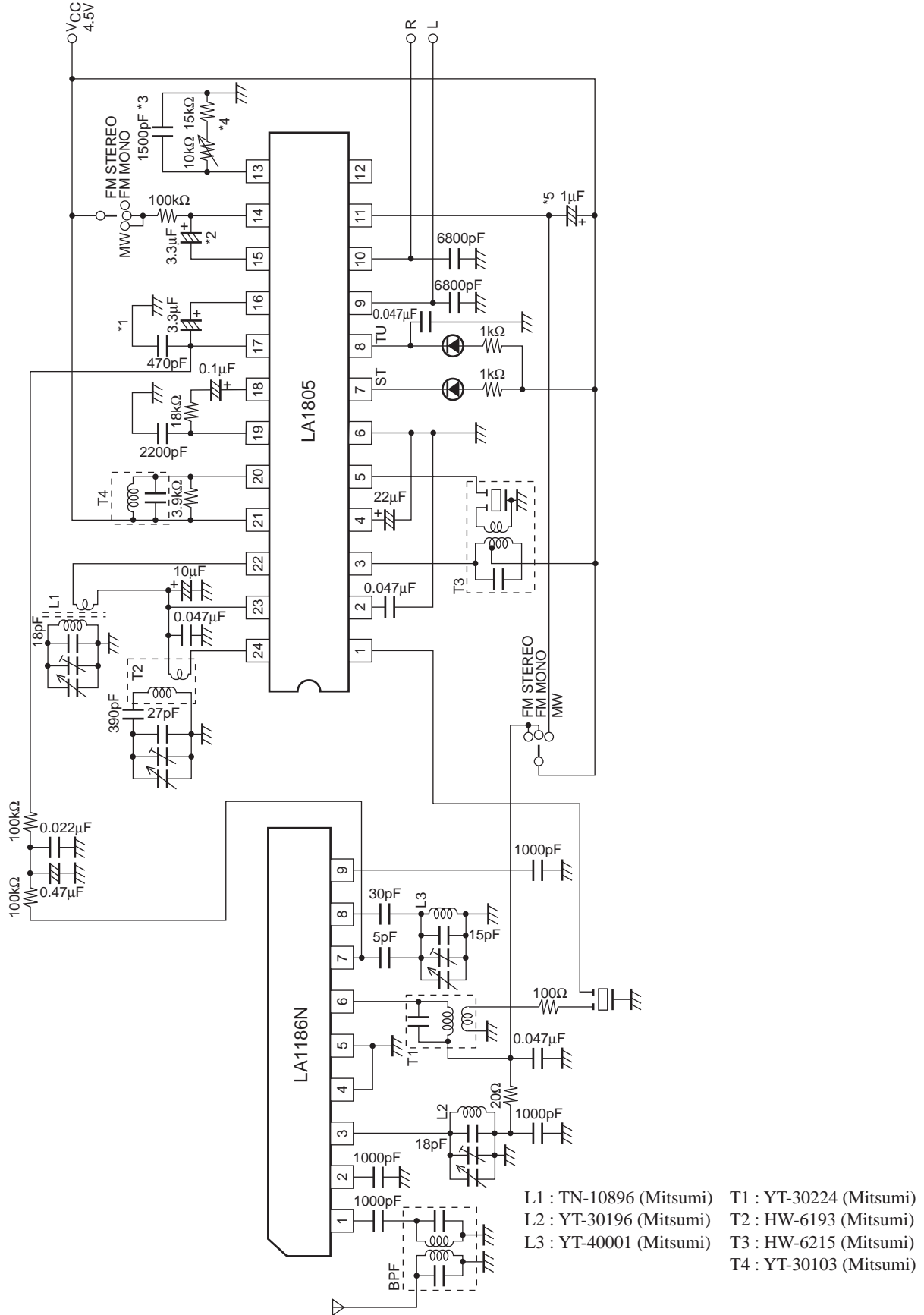

Note : The constants of parts *1 to *5 are changed from those of the LA1810.

ILA01974

LA1805

LA1806FM Characteristic

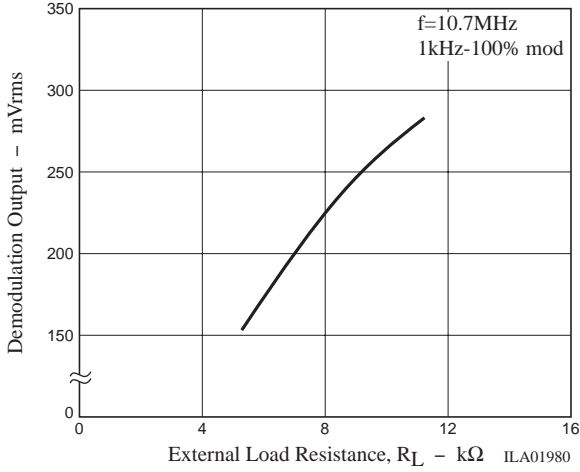

Coil Specifications

- MW bar antenna
TN-10896 (Mitsumi)

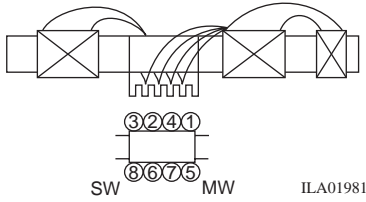

①-② 22T+49T, ③-④ 10T

⑤-⑥ 17T, 0.5φ

⑦-⑧ 4T

①-② $L=260\mu\text{H}$, $Q_0=330$ (≥ 200)

⑤-⑥ $L=15\mu\text{H}$, $Q_0=250$ (≥ 150)

- AM IFT

HW-6215 (Mitsumi)

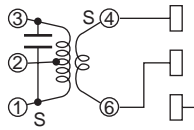

ILA01982

HW-6194

SFU-450B

①-② 94T

④-⑥ 7T

②-③ 58T

180pF

- MW OSC

HW-6193 (Mitsumi)

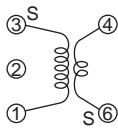

ILA01983

⑥-④ 32T

③-① 64T

$Q_0=140$, $L=140\mu\text{H}$

- FM quadrature

YT-30103 (Mitsumi)

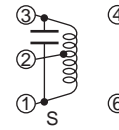

ILA01984

①-③ 10T

$Q_0=90$, $f=10.7\text{MHz}$

82pF

- SW2 OSC

HW-40184 (Mitsumi)

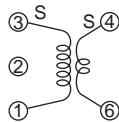

④-⑥ 8T
③-① 12T
 $Q_0 \geq 28$, $L=1.31\mu\text{H}$

0237-1500 (Mitsumi)

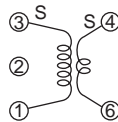

ILA01985

④-⑥ 8T

③-① 12T

$Q_0 \geq 20$, $L=1.31\mu\text{H}$

- SW2 ANT

YT-30117 (Mitsumi)

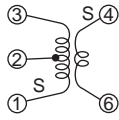

①-② 4T
④-⑥ 2T
②-③ 4T
 $Q_0=95$, $L=1.4\mu\text{H}$

2158-4095-319A (Sumida)

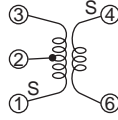

ILA01986

④-⑥ 2T

①-② 5T

②-③ 5T

$Q_0 \geq 40$, $L=1.4\mu\text{H}$

- LW bar antenna

HH-50161 (Mitsumi)

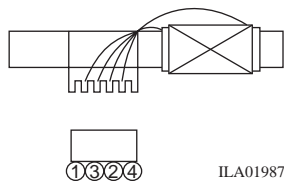

ILA01987

①-② 20T

③-④ 200T

③-④ $L=2.74\text{mH}$, $Q_0 \geq 200$

- LW OSC

MA-7014 (Mitsumi)

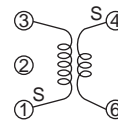

ILA01988

④-⑥ 40T

①-③ 80T

$L=220\mu\text{H}$, $Q_0=130$

- Specifications of any and all SANYO products described or contained herein stipulate the performance, characteristics, and functions of the described products in the independent state, and are not guarantees of the performance, characteristics, and functions of the described products as mounted in the customer's products or equipment. To verify symptoms and states that cannot be evaluated in an independent device, the customer should always evaluate and test devices mounted in the customer's products or equipment.
- SANYO Electric Co., Ltd. strives to supply high-quality high-reliability products. However, any and all semiconductor products fail with some probability. It is possible that these probabilistic failures could give rise to accidents or events that could endanger human lives, that could give rise to smoke or fire, or that could cause damage to other property. When designing equipment, adopt safety measures so that these kinds of accidents or events cannot occur. Such measures include but are not limited to protective circuits and error prevention circuits for safe design, redundant design, and structural design.
- In the event that any or all SANYO products(including technical data,services) described or contained herein are controlled under any of applicable local export control laws and regulations, such products must not be exported without obtaining the export license from the authorities concerned in accordance with the above law.
- No part of this publication may be reproduced or transmitted in any form or by any means, electronic or mechanical, including photocopying and recording, or any information storage or retrieval system, or otherwise, without the prior written permission of SANYO Electric Co., Ltd.
- Any and all information described or contained herein are subject to change without notice due to product/technology improvement, etc. When designing equipment, refer to the "Delivery Specification" for the SANYO product that you intend to use.
- Information (including circuit diagrams and circuit parameters) herein is for example only ; it is not guaranteed for volume production. SANYO believes information herein is accurate and reliable, but no guarantees are made or implied regarding its use or any infringements of intellectual property rights or other rights of third parties.

This catalog provides information as of January, 2006. Specifications and information herein are subject to change without notice.