

Voice Coil Motor Driver

Functions

- Input amp.
- BTL output amp.
- Current sense amp.
- Current limiter
- Input selector with disable
- OTSD (Over Temperature Shut Down)

Features

- Selectable output current
HA13470 2.5A Max.
- Easy to retract with control 2 inputs
- No cross-over distortion
- Low saturation voltage
- Externally adjustable current limiter
- Few—external components
- Wide operating voltage range

Block Diagram

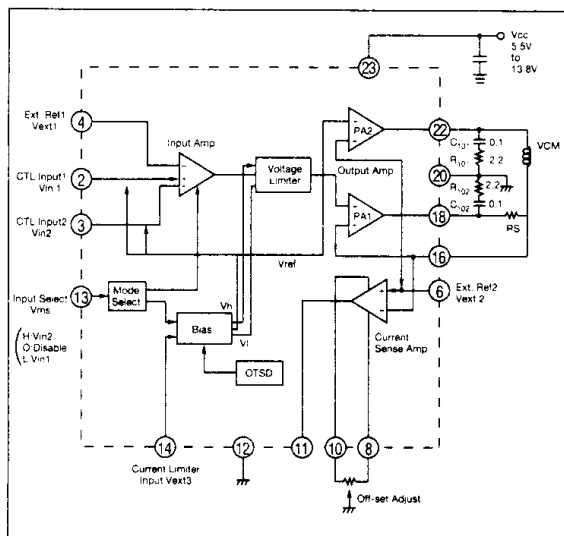

HA13470

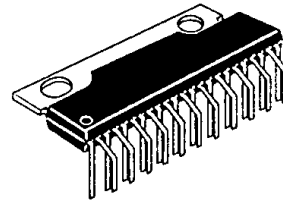

(SP-23TA)

Ordering Information

Type No.	Package
HA13470	SP-23TA

Pin Assignment

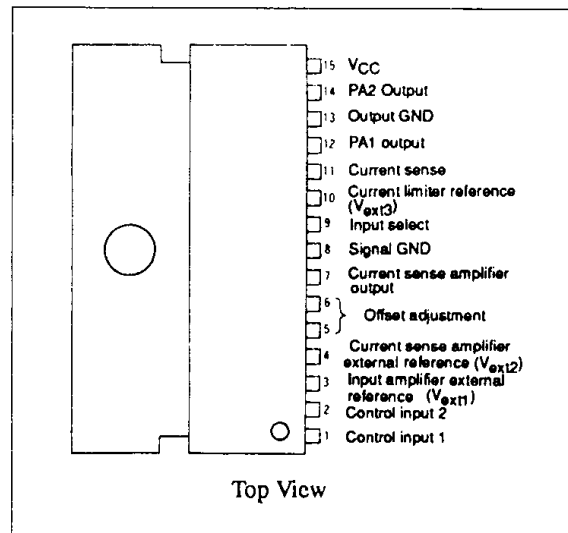

Top View

External Components

Parts No.	Recommended Value	Purpose	Note
R101, R102	2.2Ω	For Stability	
VR1	10KΩ	Offset Adjust	
Rs	1.0Ω	Current Sense	1
C101, C102	0.1μF	For Stability	
C102	≥ 0.1μF	Power Supply Bypass	

Note: 1. Use a reactance free resistance.

Current Voltage Conversion Characteristics

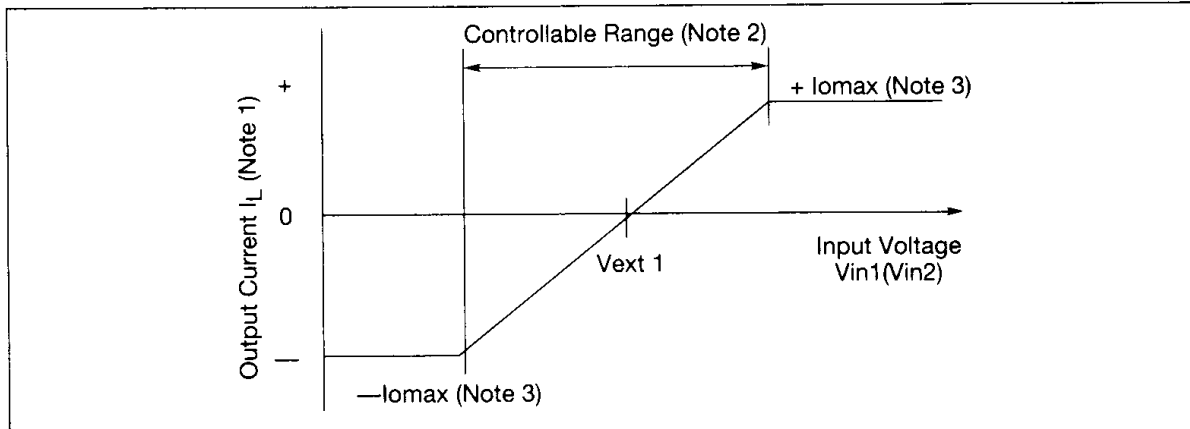

Notes: 1. Output current ⊕ means source current from Pin[®] and ⊖ means sink current.

2. In this range the relation between output current and input voltage can be described as follows (under not saturated condition at output).

$$I_o = \frac{GV_1 (V_{in} - V_{ext1})}{R_s}$$

Where $GV_1 = 2$ typ. (internal constant)

3. The relation between $+I_{omax}$ and V_{ext3} , and between $-I_{omax}$ and V_{ext3} , can be described as follows respectively.

$$+I_{omax} = \frac{GV_3 V_{ext3}}{R_s}, \quad -I_{omax} = -\frac{GV_3 V_{ext3}}{R_s}$$

Where $GV_3 = 0.5$ typ. (internal constant)

Absolute Maximum Ratings (Ta = 25°C)

Item	Symbol	HA13470	Unit	Note
Supply Voltage	Vcc	15	V	1
Output Peak Current	Iopeak	2.5	A	2
Output Constant Current	I _o	1.67	A	
Input Voltage	V _{in}	-0.5 ~ Vcc	V	
Power Dissipation	P ₁	10	W	3
Junction Temperature	T _j	150	°C	1
Storage Temperature	T _{stg}	-55 ~ +125	°C	

The absolute maximum ratings are limiting values, to be applied individually, beyond which the device may be permanently damaged. Functional operation under any of these conditions is not guaranteed. Exposing a circuit to its absolute maximum rating for extended periods of time may affect the device's reliability.

Notes: 1. The recommended operating supply voltage range is: Vcc = 5.5 to 13.8V, T_{opr} = 0 ~ +125°C

2. t ≤ 20msec.

3. The value is at Tc = 120°C. Thermal resistance show as follows: (H)_{j-c} ≤ 5°C/W, (H)_{j-a} ≤ 40°C/W



HA13470

Electrical Characteristics (Ta = 25°C, VCC = 12V, RS = 1.0Ω, RL = 4Ω)

Item	Symbol	Test Condition	min.	typ.	max.	Unit	Applicable Terminal	Note			
Quiescent Current	Icco	V _{ms} = Open	—	—	—	mA	23				
	Icc	V _{ms} = 0.8V	—	30	.50	mA					
Input Select	Input Current	V _{ms} = 0 ~ 5V	—	—	±0.5	mA	13				
	Select 1 Voltage		—	—	0.8	V					
	Disable Voltage		2	—	3	V					
	Select 2 Voltage		4.2	—	—	V					
Input Amp.	Input Current	V _{in} = 4 ~ 8V	—	—	±30	μA	2-4				
	Common Mode Input Voltage		4	—	8	V					
	Offset Voltage	V _{IO1}	V _{sens} = 0	—	—	±10			mV	2-4	1
Output Amp.	Saturation Voltage	V _{sat}	I _o = 0.55A (0.33A)	—	1.4	1.8	V	18, 22	2		
			I _o = 1.67A (1.0A)	—	2.0	2.8	V				
Input Amp. to Output Amp.	Voltage Gain	GV ₁	f _{in} = 1KHz	—	6	—	dB	16, 18	1		
	Gain Band Width	BW ₁	ΔG _{v1} = -3dB	—	—	—	KHz deg.				
	Phase Delay	Δφ	f _{in} = KHz	—	—	—					
	Total Harmonic Distortion	THD	f _{in} = 1KHz I _o = 100mArms	—	—	2	%				
Current Limiter	Input Current	I _{ext3}	V _{ext3} = 0 ~ 5V	—	—	±10	μA	14			
	Offset Voltage	V _{IO3}	V _{SCNS} = ±10mV	—	—	±50	mV				
	Setting Gain	GV ₃	V _{ext3} < 2V	—	-6	—	dB			14	3
	Gain Difference	ΔGV ₃		—	—	±1	dB				
Current Sense Amp.	Common Mode Input Voltage	V _{ext2}		4	—	8	V	6			
	Offset Voltage	V _{IO2}		—	—	±10	mV			16, 18	
	Output Voltage Swing	V _o		8	—	—	V _{PP}			11	
	Gain Band Width	BW ₂	G _v = 0dB	—	1.0	—	MHz				
OTSD	Shut Down Temperature	T _{sd}	125	150	—	°C					

Notes: 1. See Figure 1. For Offset Voltage (V_{IO1}) and by can be calibrated as.

$$G_{V1} = 20 \log_{10} \frac{\Delta V_{sens}}{\Delta V_{in}} \text{ (dB)}$$

2. Specified by the sum of upper and lower saturation voltage

3. See Figure 2.

$$G_{V0} = 20 \log_{10} \frac{\Delta V_{sens}}{\Delta V_{ext3}} \text{ (dB)}$$



The Waveform of HA13470 $R_S = 0.5\Omega$, $R_L = 4\Omega$, $L = 1.0mH$

(1) $f_{in} = 1KHz$, $V_{in} = 20mVP-P$

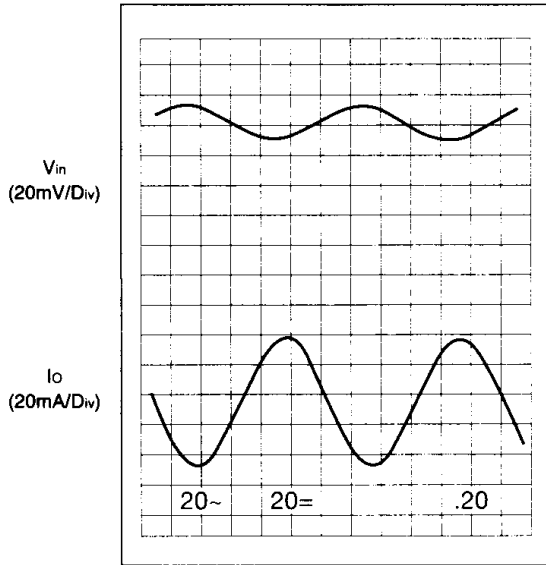

(2) $f_{in} = 1KHz$, $V_{in} = 200mVP-P$

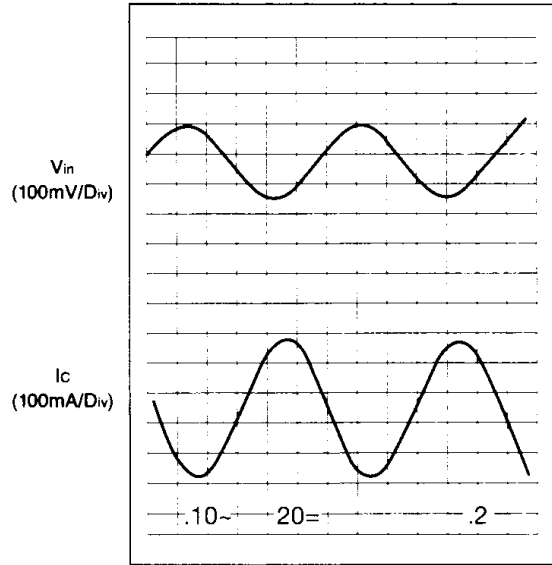

(3) $f_{in} = 400Hz$, $V_{in} = 2VP-P$, $V_{ext3} = 1.5V$

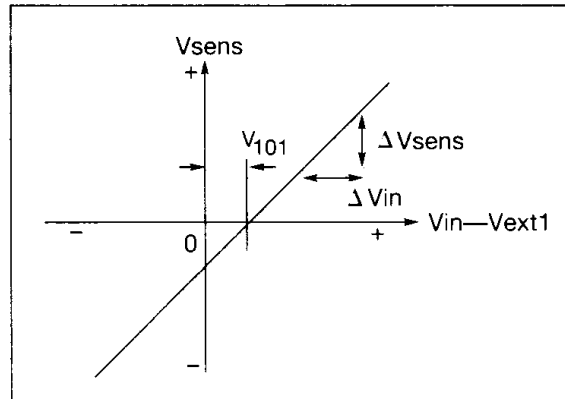
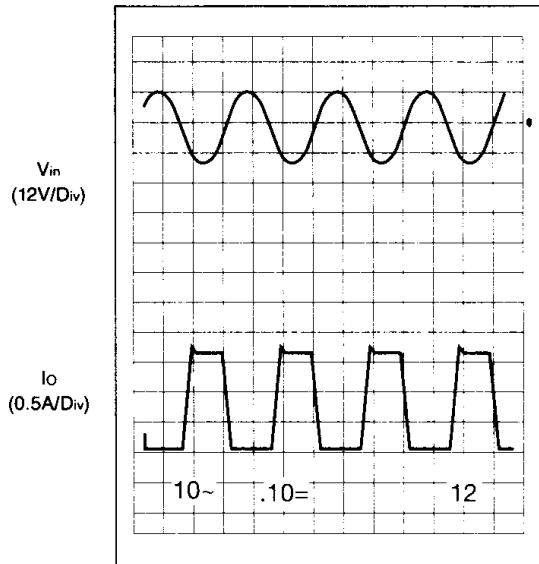

Figure 1

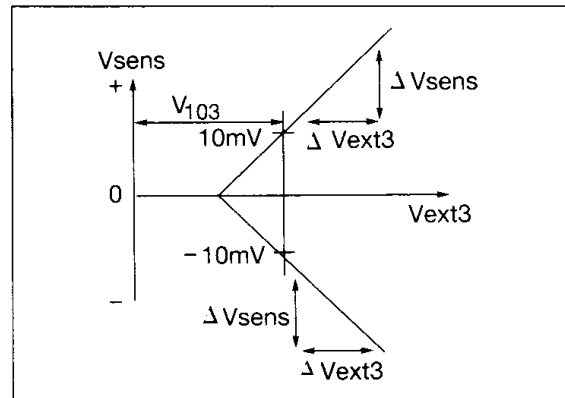
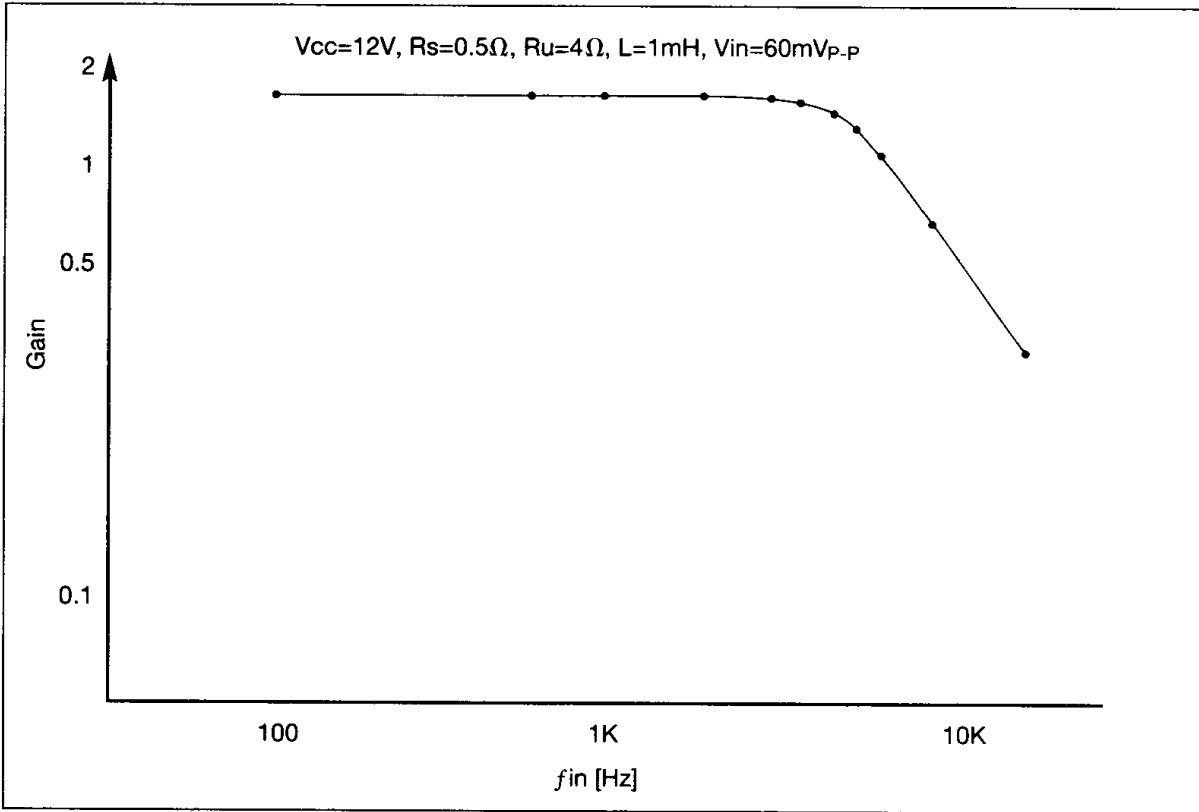

Figure 2

HA13470

HA13470 Overall, Frequency Response



HA13470 Overall, Phase Shift

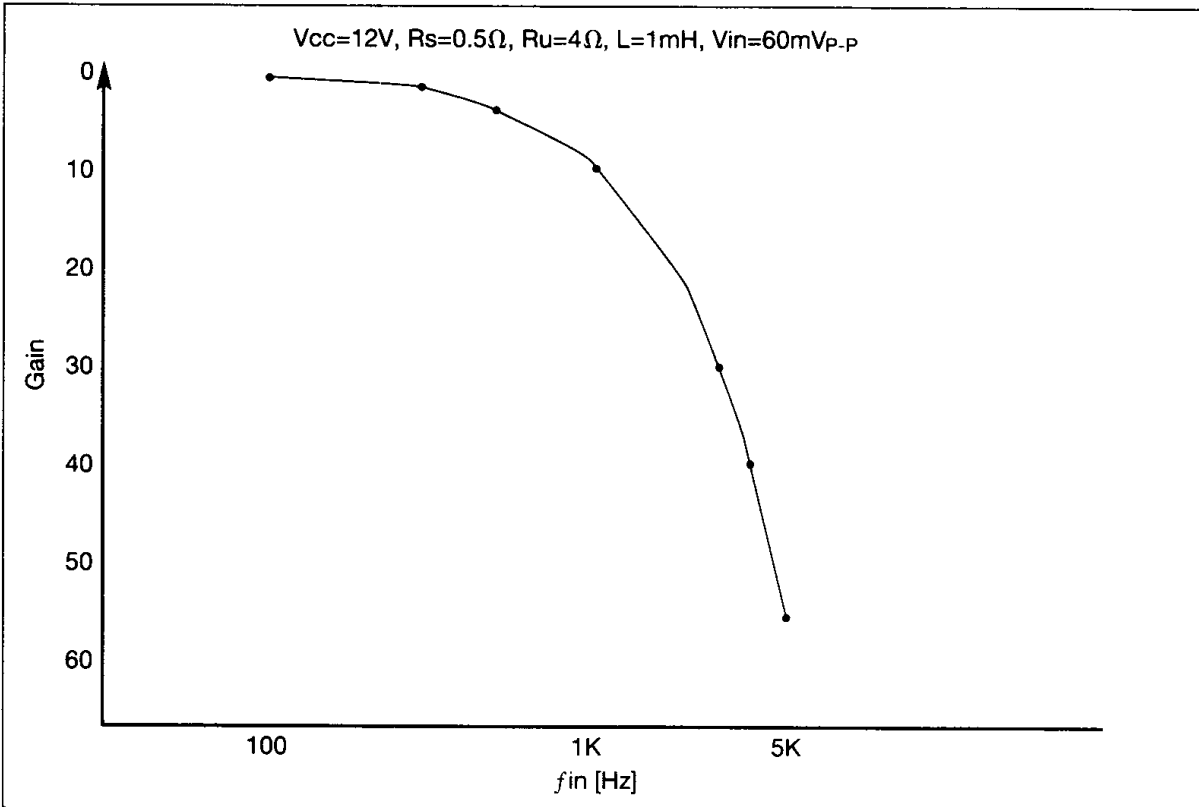

Transmitter

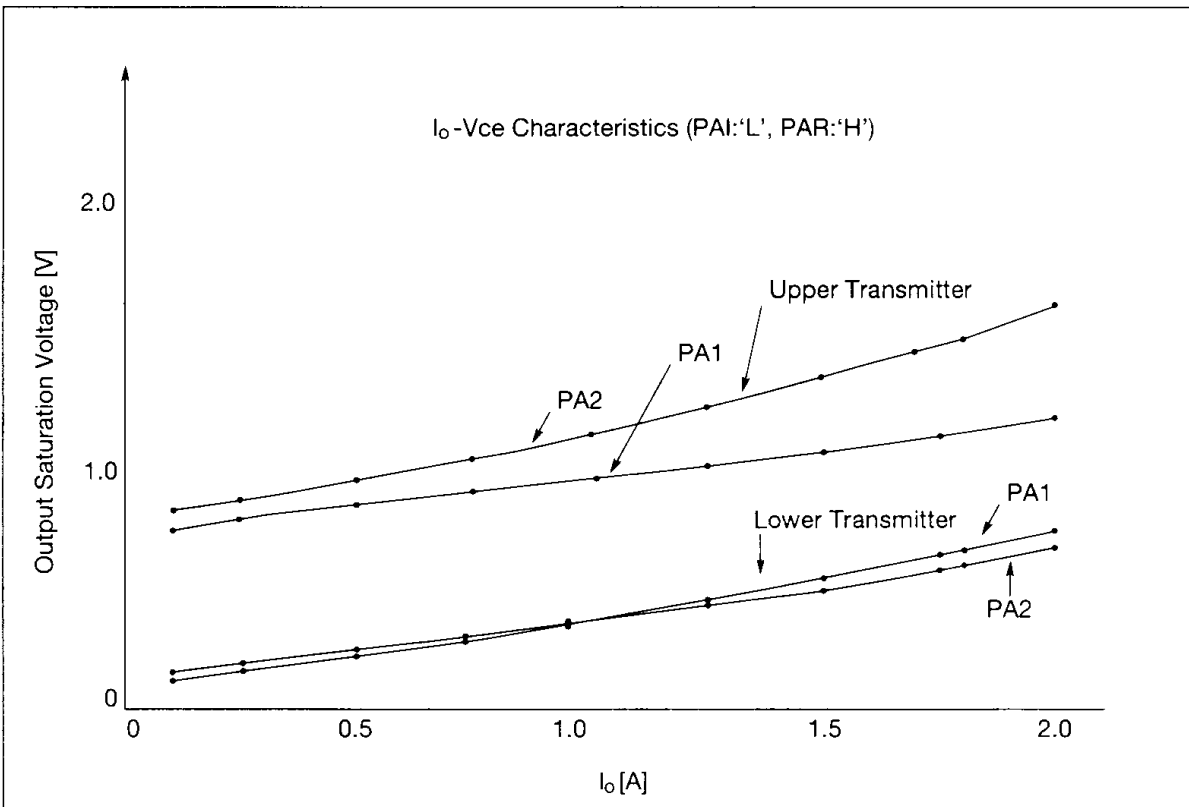

The Gain of Current Limiter V_{ext} - V_{sense}

