

To all our customers

---

## **Regarding the change of names mentioned in the document, such as Hitachi Electric and Hitachi XX, to Renesas Technology Corp.**

---

The semiconductor operations of Mitsubishi Electric and Hitachi were transferred to Renesas Technology Corporation on April 1st 2003. These operations include microcomputer, logic, analog and discrete devices, and memory chips other than DRAMs (flash memory, SRAMs etc.) Accordingly, although Hitachi, Hitachi, Ltd., Hitachi Semiconductors, and other Hitachi brand names are mentioned in the document, these names have in fact all been changed to Renesas Technology Corp. Thank you for your understanding. Except for our corporate trademark, logo and corporate statement, no changes whatsoever have been made to the contents of the document, and these changes do not constitute any alteration to the contents of the document itself.

Renesas Technology Home Page: <http://www.renesas.com>

Renesas Technology Corp.  
Customer Support Dept.  
April 1, 2003

## Cautions

Keep safety first in your circuit designs!

1. Renesas Technology Corporation puts the maximum effort into making semiconductor products better and more reliable, but there is always the possibility that trouble may occur with them. Trouble with semiconductors may lead to personal injury, fire or property damage.

Remember to give due consideration to safety when making your circuit designs, with appropriate measures such as (i) placement of substitutive, auxiliary circuits, (ii) use of nonflammable material or (iii) prevention against any malfunction or mishap.

Notes regarding these materials

1. These materials are intended as a reference to assist our customers in the selection of the Renesas Technology Corporation product best suited to the customer's application; they do not convey any license under any intellectual property rights, or any other rights, belonging to Renesas Technology Corporation or a third party.
2. Renesas Technology Corporation assumes no responsibility for any damage, or infringement of any third-party's rights, originating in the use of any product data, diagrams, charts, programs, algorithms, or circuit application examples contained in these materials.
3. All information contained in these materials, including product data, diagrams, charts, programs and algorithms represents information on products at the time of publication of these materials, and are subject to change by Renesas Technology Corporation without notice due to product improvements or other reasons. It is therefore recommended that customers contact Renesas Technology Corporation or an authorized Renesas Technology Corporation product distributor for the latest product information before purchasing a product listed herein.  
The information described here may contain technical inaccuracies or typographical errors. Renesas Technology Corporation assumes no responsibility for any damage, liability, or other loss rising from these inaccuracies or errors.  
Please also pay attention to information published by Renesas Technology Corporation by various means, including the Renesas Technology Corporation Semiconductor home page (<http://www.renesas.com>).
4. When using any or all of the information contained in these materials, including product data, diagrams, charts, programs, and algorithms, please be sure to evaluate all information as a total system before making a final decision on the applicability of the information and products. Renesas Technology Corporation assumes no responsibility for any damage, liability or other loss resulting from the information contained herein.
5. Renesas Technology Corporation semiconductors are not designed or manufactured for use in a device or system that is used under circumstances in which human life is potentially at stake. Please contact Renesas Technology Corporation or an authorized Renesas Technology Corporation product distributor when considering the use of a product contained herein for any specific purposes, such as apparatus or systems for transportation, vehicular, medical, aerospace, nuclear, or undersea repeater use.
6. The prior written approval of Renesas Technology Corporation is necessary to reprint or reproduce in whole or in part these materials.
7. If these products or technologies are subject to the Japanese export control restrictions, they must be exported under a license from the Japanese government and cannot be imported into a country other than the approved destination.  
Any diversion or reexport contrary to the export control laws and regulations of Japan and/or the country of destination is prohibited.
8. Please contact Renesas Technology Corporation for further details on these materials or the products contained therein.

---

# HA12237F

## Audio Signal Processor for Cassette Deck



ADE-207-343 (Z)

Rev.0  
Feb. 2002

---

### Description

HA12237F is silicon monolithic bipolar IC providing PB equalizer, REC equalizer system, ALC and each electronic control switch in one chip.

### Functions

- PB equalizer       × 2 channel
- REC equalizer     × 2 channel
- ALC (Automatic Level Control)
- REC mute
- REC head return switch
- Line Amp.         × 2 channel
- Line mute

### Features

- REC equalizer is very small number of external parts built-in 2 types of frequency characteristics.
- TYPE I REC correspondence, High-speed dubbing correspondence.
- PB equalizer circuit built-in 2 types of frequency characteristics. (external parts of capacitor only)
- Head control switch built-in.
- Line mute switch built-in.
- Controllable from direct micro-computer output.

## Parallel Data Format

Pin No.	Pin Name	Lo	Hi
11	ALC ON/ $\overline{\text{OFF}}$	ALC OFF	ALC ON
12	High/ $\overline{\text{Norm}}$	Normal speed	High speed
13	A/ $\overline{\text{B}}$	B	A
	REC Return ON/ $\overline{\text{OFF}}$	Return OFF	Return ON
14	MUTE ON/ $\overline{\text{OFF}}$	MUTE OFF	MUTE ON
15	REC MUTE OFF/ $\overline{\text{ON}}$	REC MUTE ON	REC MUTE OFF

### Pin Description, Equivalent Circuit

( $V_{CC} = 12\text{ V}$ ,  $T_a = 25^\circ\text{C}$ , No Signal, The value in the table shows typical value.)

Pin No.	Pin Name	Note	Equivalent Circuit	Description
16	$V_{CC}$	$V = V_{CC}$		$V_{CC}$ pin
21	RECOUT(L)	$V = V_{CC}/2$		REC output
10	RECOUT(R)			PB output
26	PBOUT(L)			
5	PBOUT(R)			
28	EQOUT(L)	$V = 2.9\text{ V}$		EQ output
3	EQOUT(R)			
35	REC-RETURN	$V = 0\text{ V}$		REC Return
34	BIN(L)			PB B deck input
37	BIN(R)			
32	AIN(L)	$V = 0\text{ V}$		PB A deck input
39	AIN(R)			
24	RECIN(L)	$V = V_{CC}/2$		REC-EQ input
7	RECIN(R)			
27	TAI(L)	$V = V_{CC}/2$		Tape input
4	TAI(R)			

## Pin Description, Equivalent Circuit (cont)

( $V_{CC} = 12\text{ V}$ ,  $T_a = 25^\circ\text{C}$ , No Signal, The value in the table shows typical value.)

Pin No.	Pin Name	Note	Equivalent Circuit	Description
11	ALC ON/OFF	(Control voltage = 3 V)		Mode control input
12	High/Norm			
13	A/B			
14	MUTE ON/OFF			
15	REC MUTE OFF/ON			
19	IREF	$V = 1.2\text{ V}$		Equalizer reference current input
18, 36	GND			GND pin
6, 9, 22, 25, 38	NC			NC pin
20	Test mode			Test mode pin
31	PB-NF1(L)	$V = 0.6\text{ V}$		PB EQ feed back
40	PB-NF1(R)			
30	PB-NF2(L)			
1	PB-NF2(R)			

**Pin Description, Equivalent Circuit (cont)**

( $V_{CC} = 12\text{ V}$ ,  $T_a = 25^\circ\text{C}$ , No Signal, The value in the table shows typical value.)

Pin No.	Pin Name	Note	Equivalent Circuit	Description
33	RIP	$V = V_{CC}/2$		Ripple filter
29	PB-EQ(L)			NAB output
2	PB-EQ(R)			

## Block Diagram

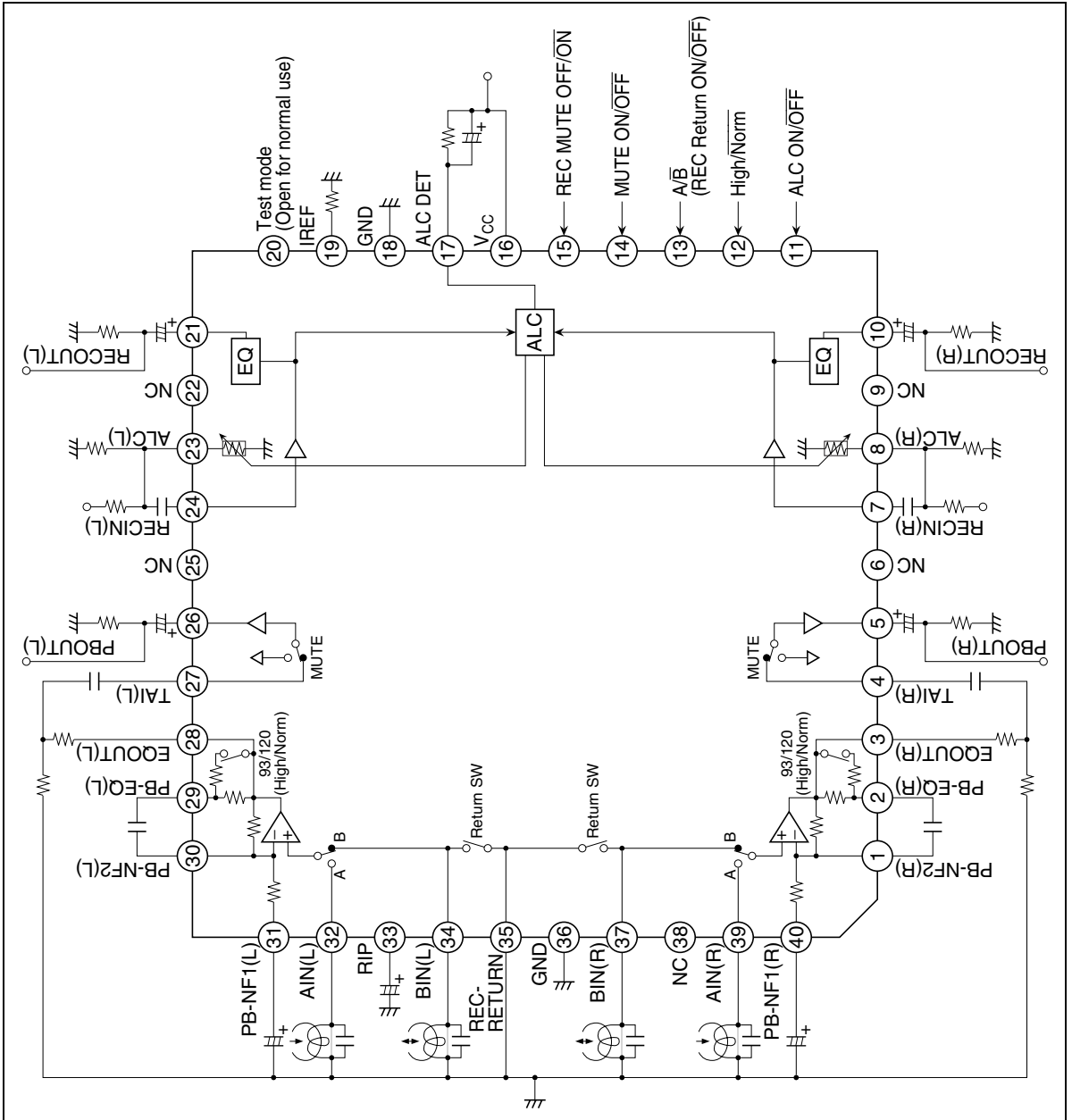



## Functional Description

### Power Supply Range

This IC designed to operate on single supply, shown by table 1.

**Table 1**      **Supply Voltage**

Item	Power Supply Range
Single supply	6.5 V to 15.0 V

### Reference Voltage

This device provide the reference voltage of half the supply voltage that is the signal grounds. As the peculiarity of this device, the capacitor for the ripple filter is very small about 1/100 compared with their usual value. The block diagram is shown as figure 1.

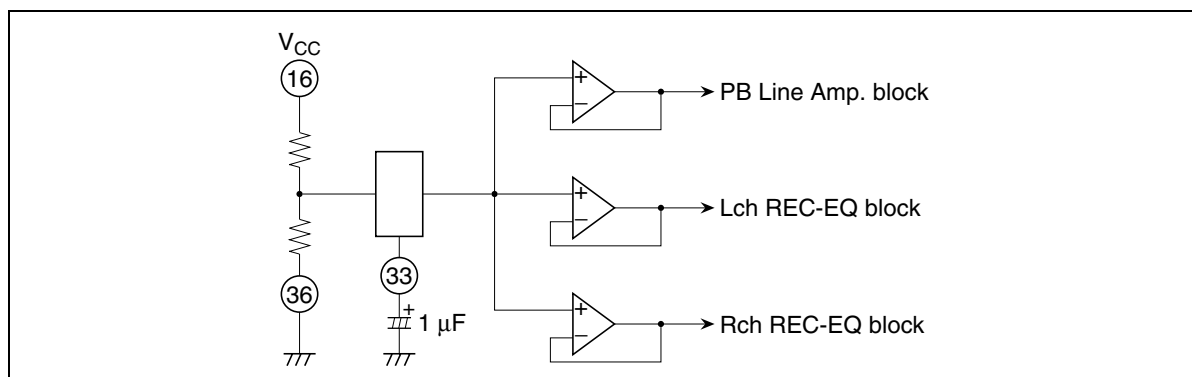
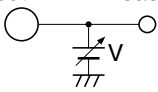

**Figure 1**      **Block Diagram of Reference Supply Voltage**

## Operating Mode Control

HA12235F provide fully electronic switching circuits. And each operating mode control is controlled by parallel data (DC voltage).

**Table 2** Threshold Voltage ( $V_{TH}$ )

Pin No.	Lo	Mid	Hi	Unit	Test Condition
11 to 15	-0.2 to 0.5	—	2.4 to $V_{CC}$	V	Input Pin Measure 

- Notes: 1. Each pins are on pulled down with 100 k $\Omega$  internal resistor. Therefore, it will be low-level when each pins are open.
2. Over shoot level and under shoot level of input signal must be the standardized.  
(High:  $V_{CC}$ , Low: -0.2 V)

## Test Mode

Test mode becomes when pin 20 is shorted to GND. Please open pin 20 on the occasion of mount.

**Block Diagram**

As this IC is built-in REC return switch, the configuration system can be simple system using a few external component and the REC/PB head.

About these logics, please look at the Parallel Data Format.

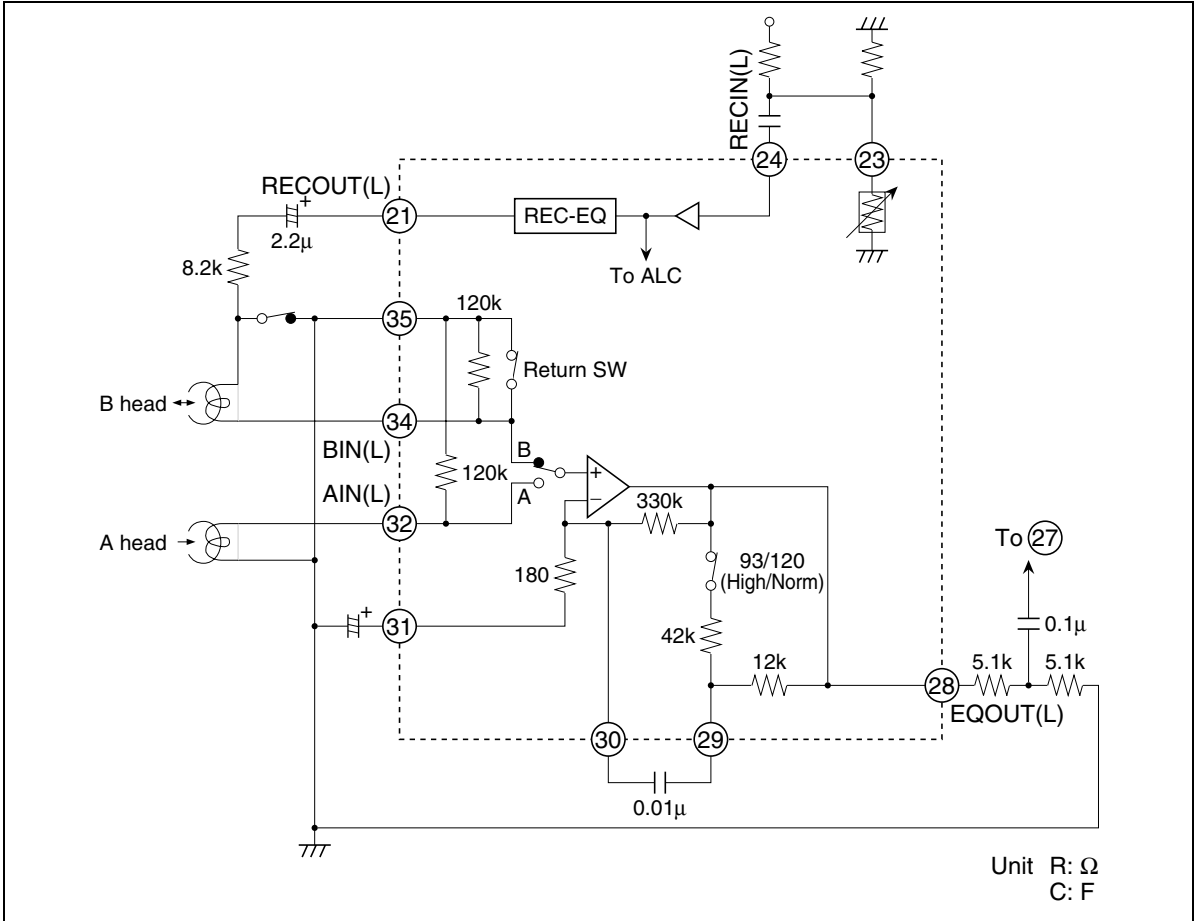

**Figure 2 Block Diagram (Lch)**

## PB Equalizer

The gain establishment of PB-EQ considers PB output level {(internal Line Amp. + PB Amp.) = 580 mVrms} like figure 3 at the target.

After replace RA and RB with a half-fix volume, adjust level.

REC-EQ adjust the gain in front of input to this IC.

The level digram of 1 kHz is shown figure 3.

Please set “RA + RB  $\geq$  10 k $\Omega$ ”

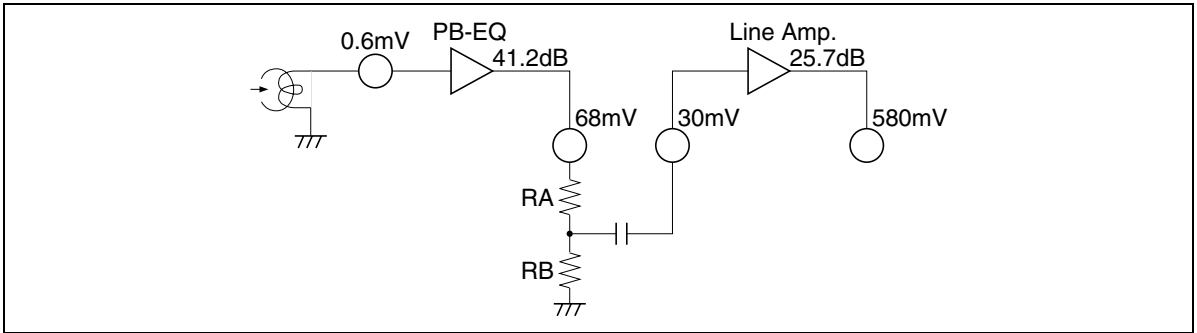

**Figure 3 PB System Level Diagram (1 kHz)**

## Line Mute

This IC is built-in with mute circuit to Line Amp.

A mute control does with Low/High of pin 14.

Reducing pop noise is so much better 10 k $\Omega$  to 22 k $\Omega$  resistor to pin 14 in series and 1  $\mu$ F to 22  $\mu$ F capacitor.

A mute is not built-in when doing a power ON/OFF.

Please correspond to it, on the side of a set system.

**REC Equalizer**

REC-EQ gain adjust before the input of this IC.

$R_L$  needs the value more than 5.6 k $\Omega$  based on the output at reference input.

Because mode establishment resistances are built-in, REC-EQ frequency characteristics are respectively fixed value.

In vase the change of the frequency characteristics are necessary, please inquire the responsible agent because the adjustment of resistors is necessary.

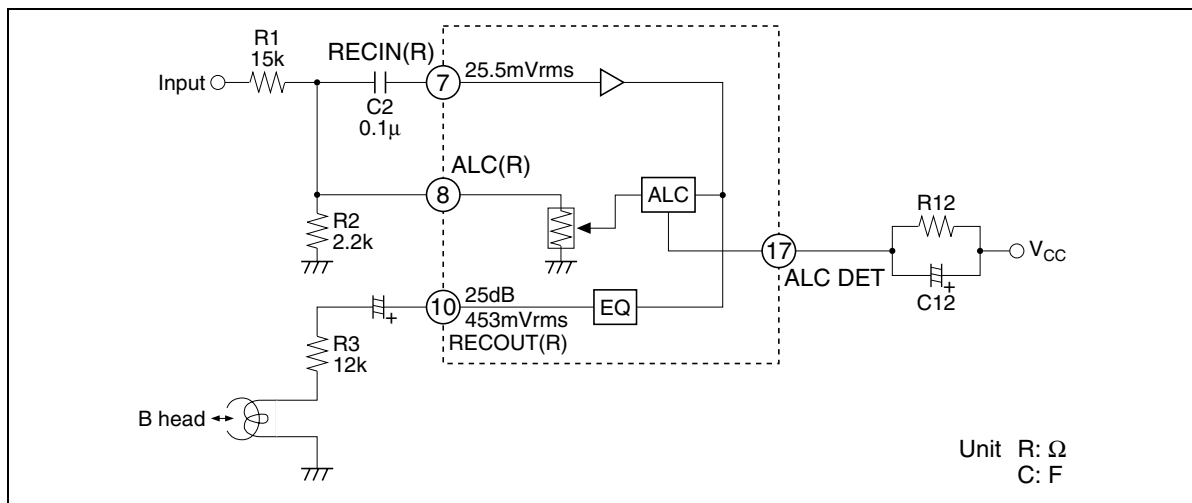

**Figure 4 REC-EQ Block Diagram**

## ALC (Automatic Level Control)

ALC is the input decay rate variable system. It has internal variable resistors of pin 8 (pin 23) by REC signal that is inputted to pin 7 (pin 24).

Pin 17 is detector pin.

The signal input pin is pin 7 (pin 24). Resistor R1, R2 and capacitor C2, external components, for the input circuit are commended as figure 4. There are requested to use value of the block diagram figure for performance maintenance of S/N, T.H.D. etc.

Figure 5 shows the relation with R1 and C1 front input point and RECOUT.

ALC operation level acts for the center of +4.5 dB to standard level (453 mVrms).

Then, adopted maximum value circuit, ALC is operated by a large channel of signal.

ALC ON/OFF can switch it by pin 11. Please do ALC ON, after it does for one time ALC OFF inevitably, for ALC time to start usefully, in order to reset ALC circuit.

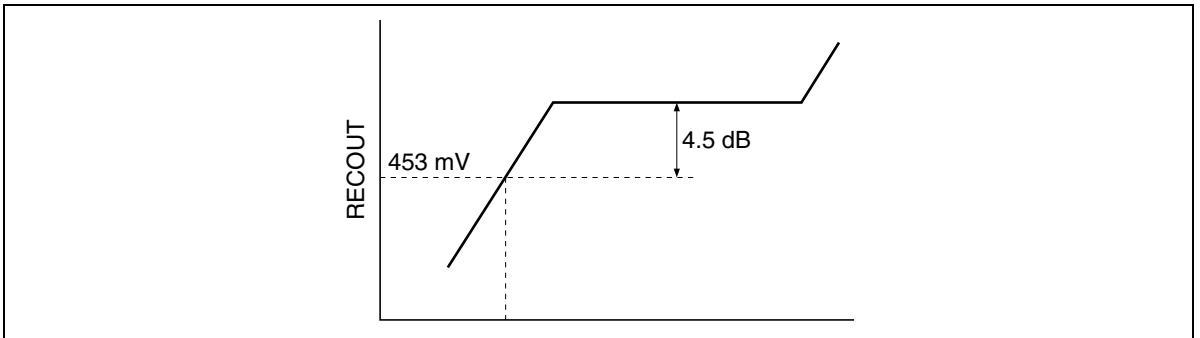

**Figure 5 ALC Operation Level**

## Absolute Maximum Ratings

(Ta = 25°C)

Item	Symbol	Rating	Unit	Note
Maximum supply voltage	V <sub>cc</sub> Max	16	V	
Power dissipation	P <sub>T</sub>	625	mW	Ta ≤ 75°C
Operating temperature	Topr	-40 to +75	°C	
Storage temperature	Tstg	-55 to +125	°C	
Operating voltage	Vopr	6.5 to 15	V	

Note: HA12235F operates on single supply voltage.

Electrical Characteristics

(Ta = 25°C, Vcc = 12 V, PB-EQIN Standard level = 0.6 mVrms at 1 kHz, TAI Standard level = 30 mVrms, PBOUT Standard level = 580 mVrms)

Item	Symbol	Test Condition						Specification				Application Terminal			
		IC Condition		fin (Hz)	Vin (mVrms)	Other	Min	Typ	Max	Unit	Input		Output		COM Remark
		A/B	High/Norm								ALC ON/OFF	R	L	R	
Quiescent current	I <sub>Q</sub>	A	Norm	OFF	—	No signal	—	12.2	20.2	mA	—	—	—	16	
Logical threshold	V <sub>IL</sub>	—	—	—	—	—	—	—	0.5	V	—	—	—	11 to 15	
	V <sub>IH</sub>	—	—	—	—	—	—	—	V <sub>CC</sub>	V	—	—	—	11 to 15	
PB-REC crosstalk	GT PB/REC(1)	A	Norm	OFF	1k	REC-EQ→PB-EQ	*1	50.0	60.0	dB	7	24	3	28	
	GT PB/REC(2)	A	Norm	OFF	1k	PB-EQ→REC-EQ	6.0	60.0	70.0	dB	39	32	10	21	
PB-EQ gain	GV PB(1)	A/B	Norm	OFF	1k	—	0.6	37.4	40.4	43.4	39/37	28/29	3	28	
	GV PB(2)	A	Norm	OFF	10k	—	0.6	33.3	36.3	39.3	39	32	3	28	
	GV PB(3)	A	High	OFF	20k	—	0.6	31.2	34.2	37.2	39	32	3	28	
PB-EQ maximum output level	Vomax PB	A	Norm	OFF	1k	THD = 1%	—	0.3	0.6	—	39	32	3	28	
PB-EQ T.H.D.	THD PB	A/B	Norm	OFF	1k	—	2.4	—	0.2	0.5	—	39/37	28/29	3	28
PB-EQ noise voltage	VN PB	A/B	Norm	OFF	—	—	—	—	110	200	μVrms	39/37	28/29	3	28
PB-EQ channel separation	CT R/L(1)	A	Norm	OFF	1k	—	6.0	50.0	60.0	—	39	32	3	28	
PB-EQ crosstalk	CT A/B	A/B	Norm	OFF	1k	—	6.0	60.0	70.0	—	39/37	28/29	3	28	
Line Amp. gain	G <sub>v</sub> LA	A	Norm	OFF	1k	—	30.0	24.2	25.7	27.2	4	27	5	26	
Line Amp. T.H.D.	THD LA	A	Norm	OFF	1k	—	30.0	—	0.05	0.30	4	27	5	26	
Line Amp. maximum output level	Vomax LA	A	Norm	OFF	1k	THD = 1%	—	1.16	1.40	—	4	27	5	26	
Line mute attenuation	L-MUTE ATT	A	Norm	OFF	1k	—	120.0	70.0	80.0	—	4	27	5	26	

Notes: 1. Large level without clipping  
2. V<sub>CC</sub> = 6.5V



## Electrical Characteristics (cont)

(Ta = 25°C, V<sub>CC</sub> = 12 V, RECIN Standard level = 200 mVrms (IC in Level = 25.5 mVrms) = 0 dB

Item	Symbol	Test Condition						Specification			Application Terminal			COM Remark		
		IC Condition		f <sub>in</sub> (Hz)	V <sub>in</sub> (mVrms)	Other	Min	Typ	Max	Input		Output				
		A/B	High/ Norm							ALC ON/OFF	R	L	R		L	
ALC operate level	ALC	A	Norm	ON	1k	+12		2.0	4.5	7.0	dB	7	24	10	21	—
REC-EQ frequency characteristics	GV REC-NN1	A	Norm	OFF	1k	-26		23.5	25.0	26.5	dB	7	24	10	21	—
Normal speed	GV REC-NN2	A	Norm	OFF	5k	-26		26.9	28.9	30.9	dB	7	24	10	21	—
	GV REC-NN3	A	Norm	OFF	10k	-26		33.2	35.7	38.2	dB	7	24	10	21	—
	GV REC-HN1	A	High	OFF	2k	-26		23.4	24.9	26.4	dB	7	24	10	21	—
High speed	GV REC-HN2	A	High	OFF	10k	-26		26.5	28.5	30.5	dB	7	24	10	21	—
	GV REC-HN3	A	High	OFF	20k	-26		33.4	35.9	38.4	dB	7	24	10	21	—
	CT R/L(2)	A	Norm	OFF	1k	*1		61.0	70.0	—	dB	7	24	10	21	—
REC-MUTE attenuation	R-MUTE ATT	A	Norm	OFF	1k	*1		66.0	76.0	—	dB	7	24	10	21	—
REC-EQ maximum output level	Vomax REC	A	Norm	OFF	1k	—	THD = 1%	0.7	1.0	—	Vrms	7	24	10	21	*2
REC-EQ T.H.D.	THD REC	A	Norm	OFF	1k	0		—	0.2	0.5	%	7	24	10	21	—
REC-EQ S/N	S/N REC	A	Norm	OFF	1k	—	Rg = 2.2kΩ, A-WTG	55.0	59.0	—	dB	—	—	10	21	—

Notes: 1. Large level without clipping

2. V<sub>CC</sub> = 6.5V

## Test Circuit

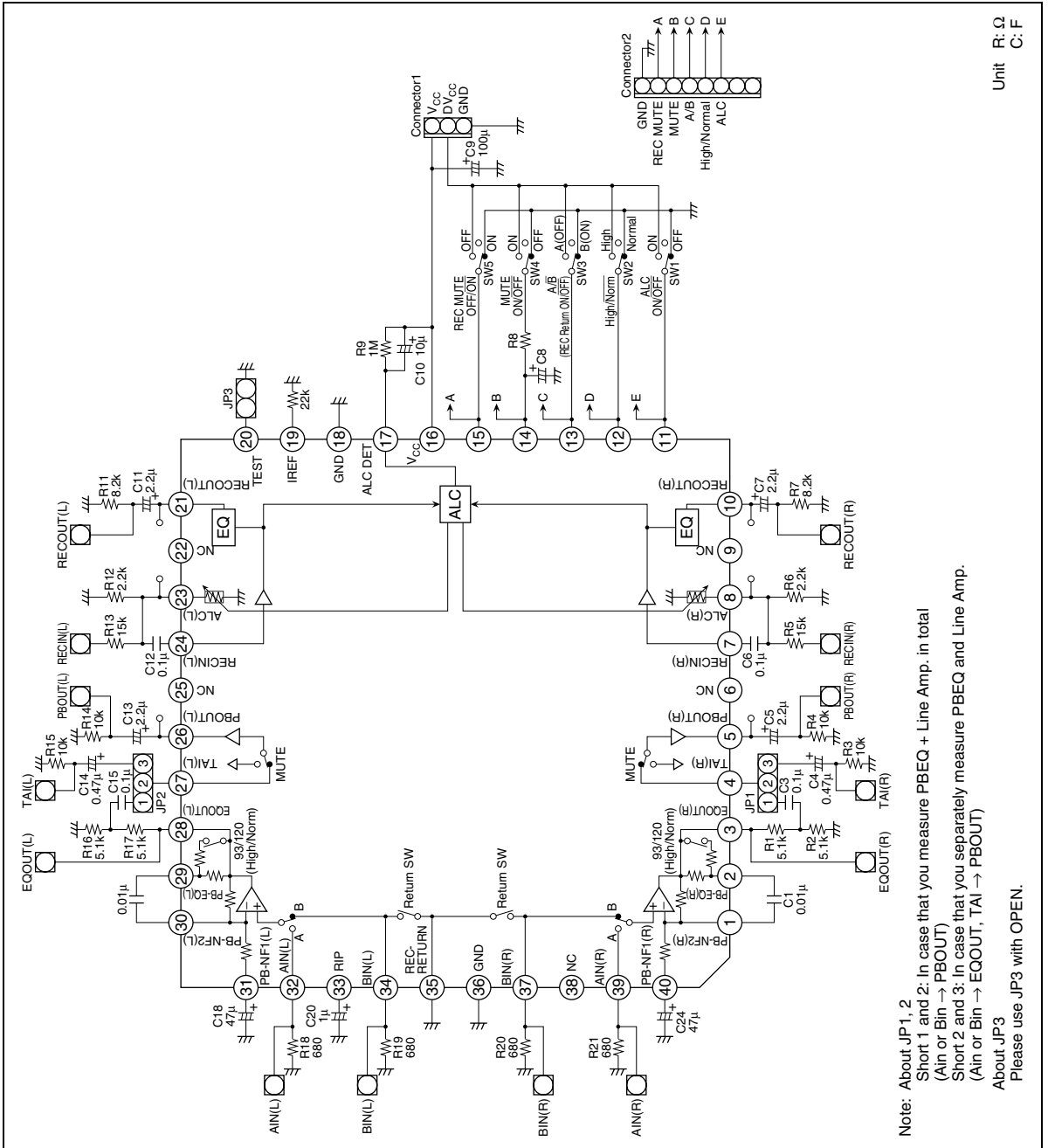

Unit R: Ω  
C: F

Note: About JP1, 2  
 Short 1 and 2: In case that you measure PBEQ + Line Amp. in total  
 (Ain or Bin → PBOUT)  
 Short 2 and 3: In case that you separately measure PBEQ and Line Amp.  
 (Ain or Bin → EQOUT, TAI → PBOUT)  
 About JP3  
 Please use JP3 with OPEN.

Characteristic Curves

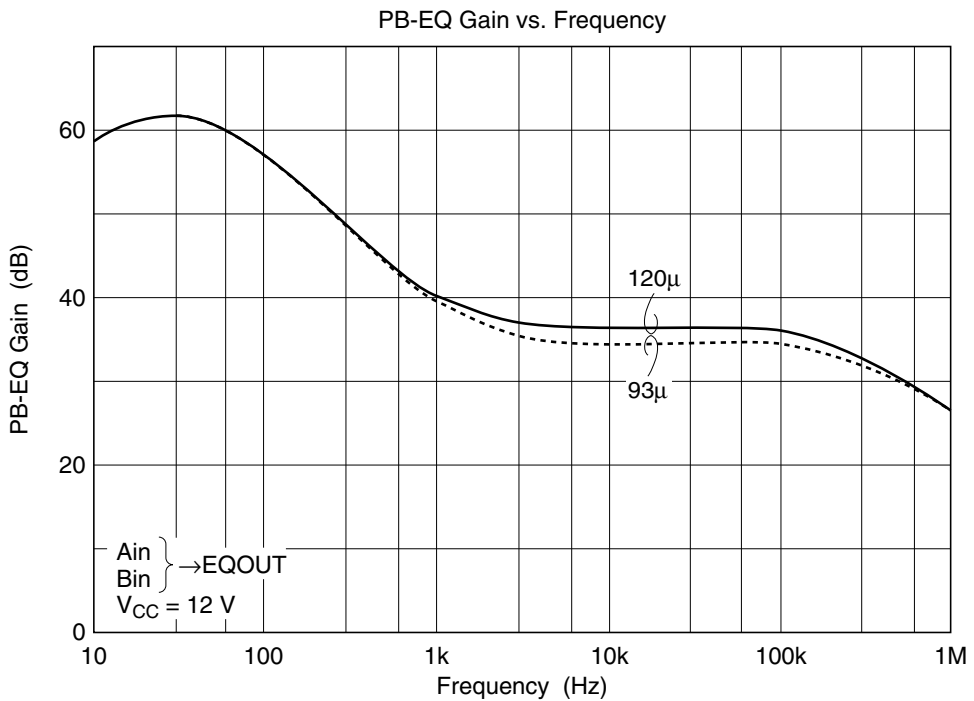
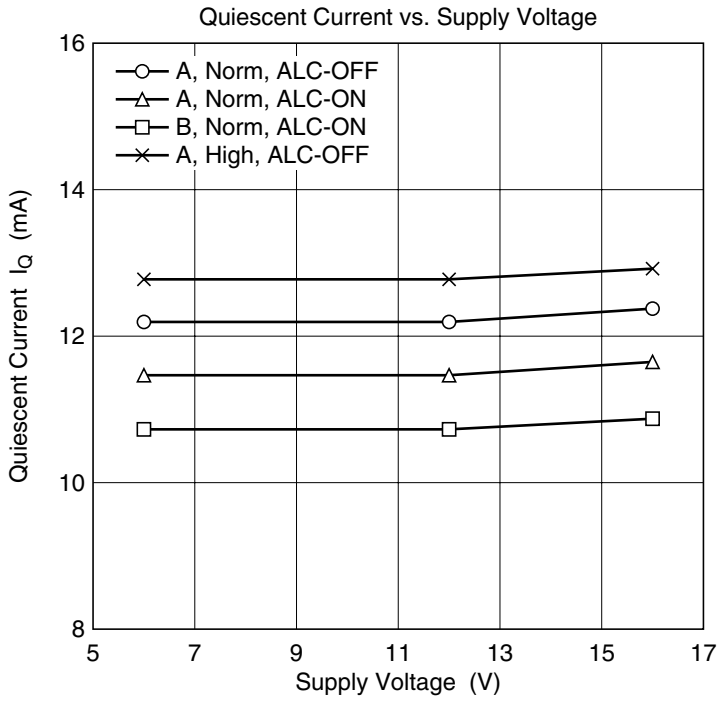

PB-EQ Maximum Output Level vs. Supply Voltage

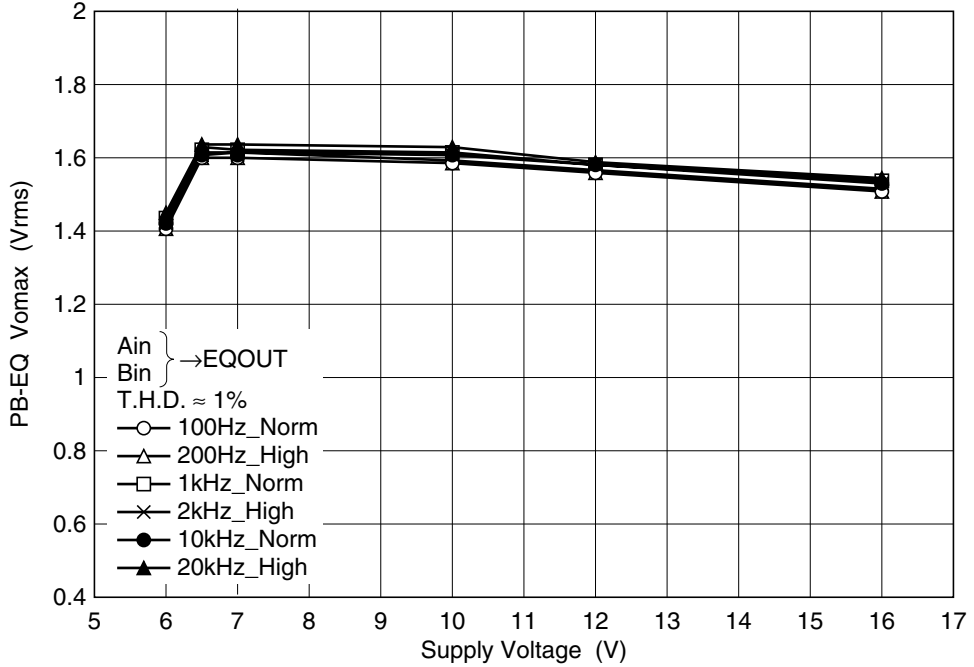

PB-EQ Total Harmonic Distortion vs. Output Level (1)

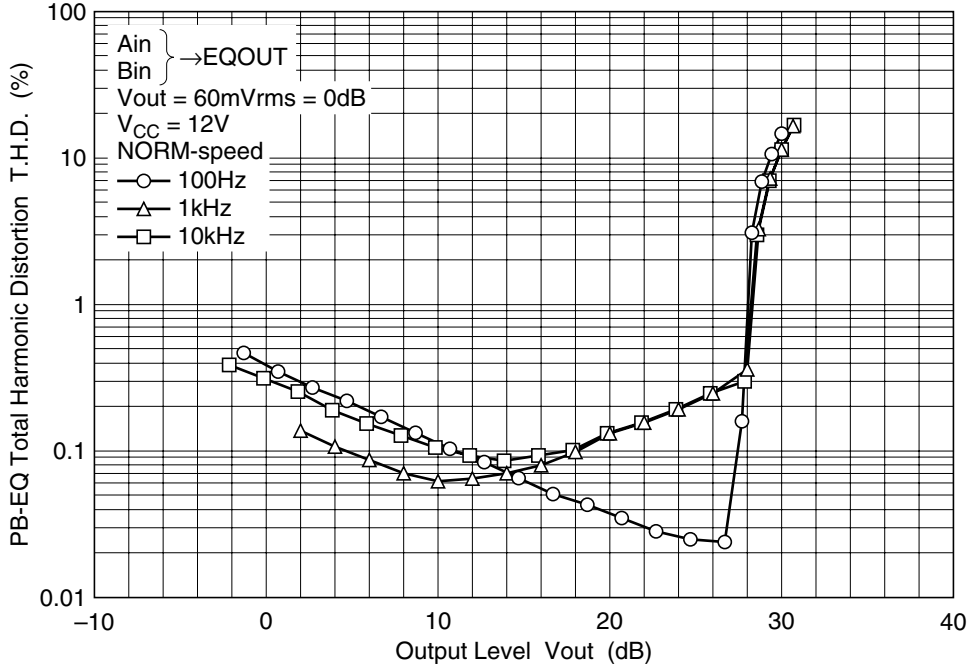

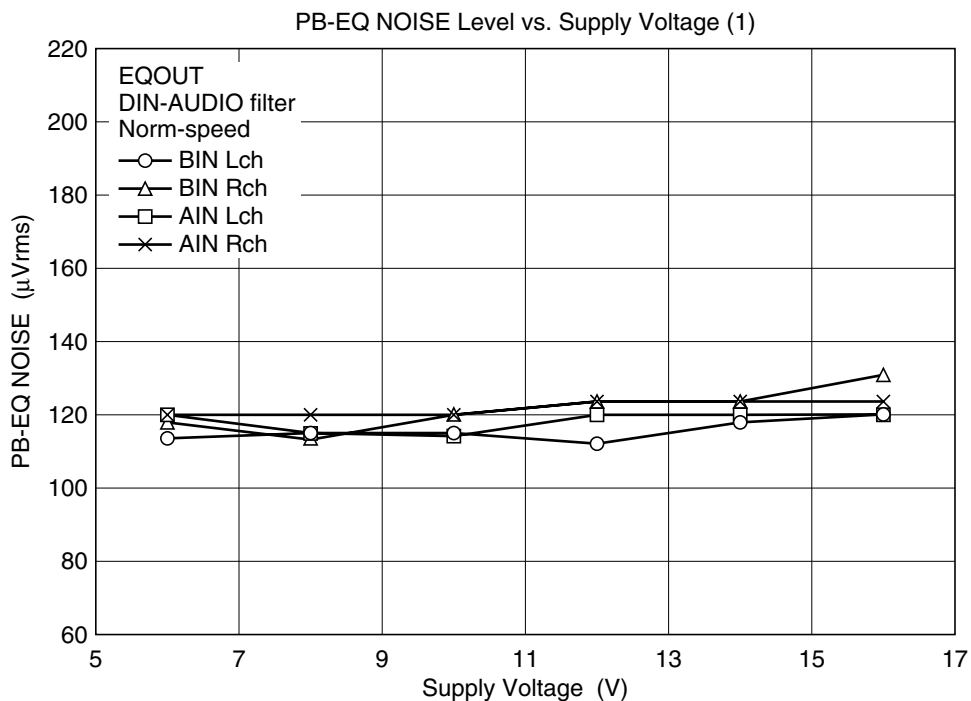
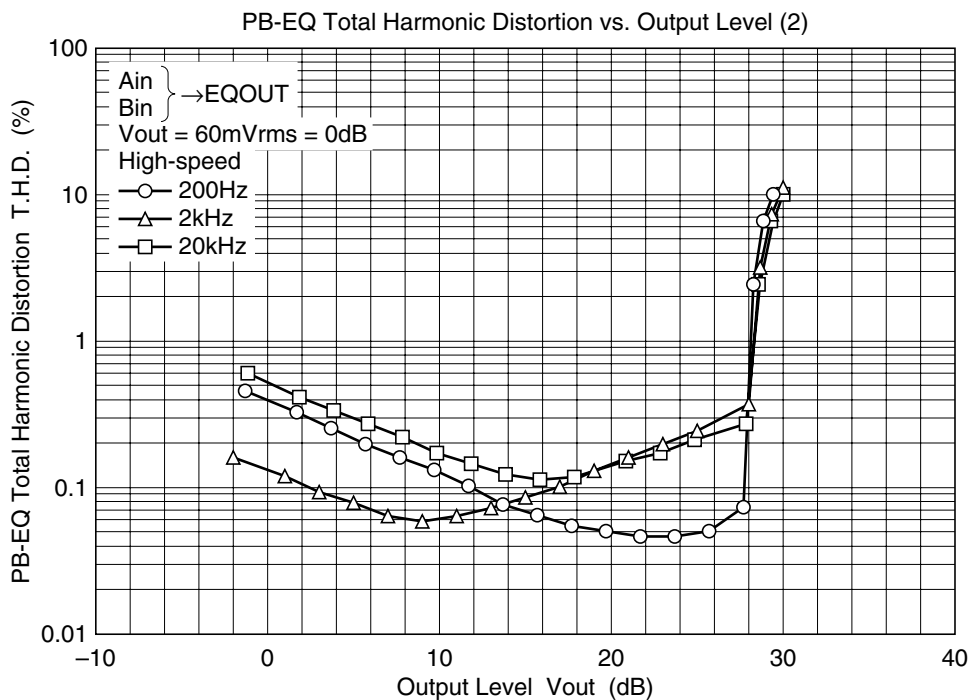

PB-EQ NOISE Level vs. Supply Voltage (2)

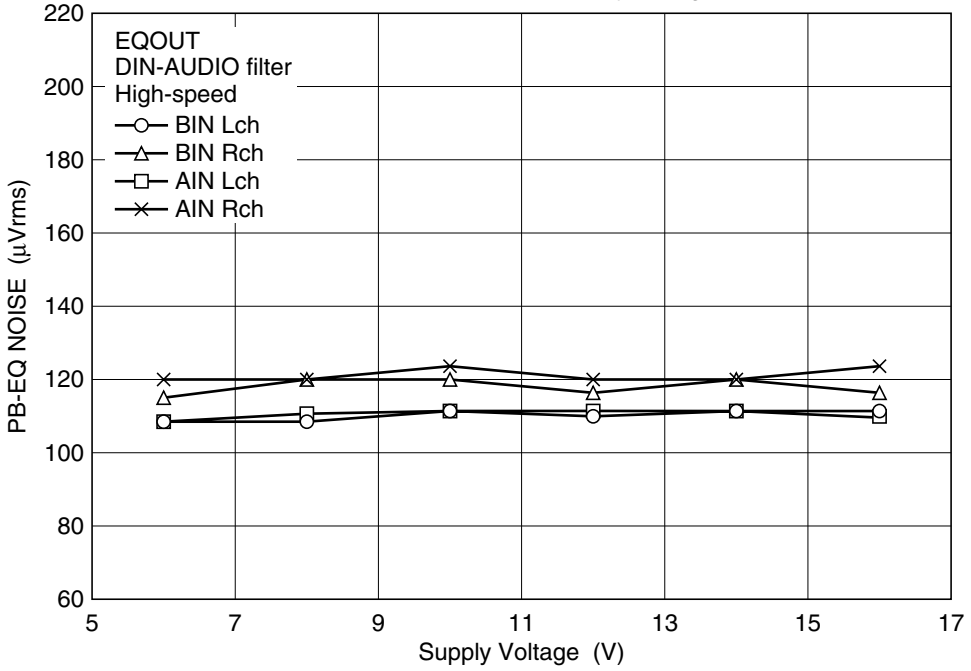

PB-EQ Channel Separation vs. Frequency (L→R) (1)

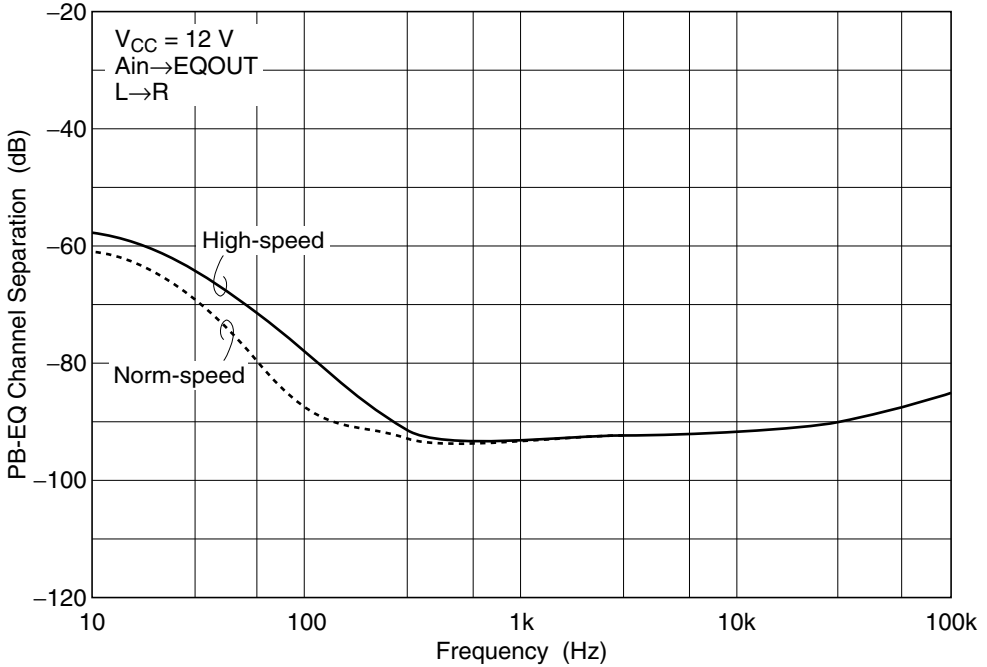

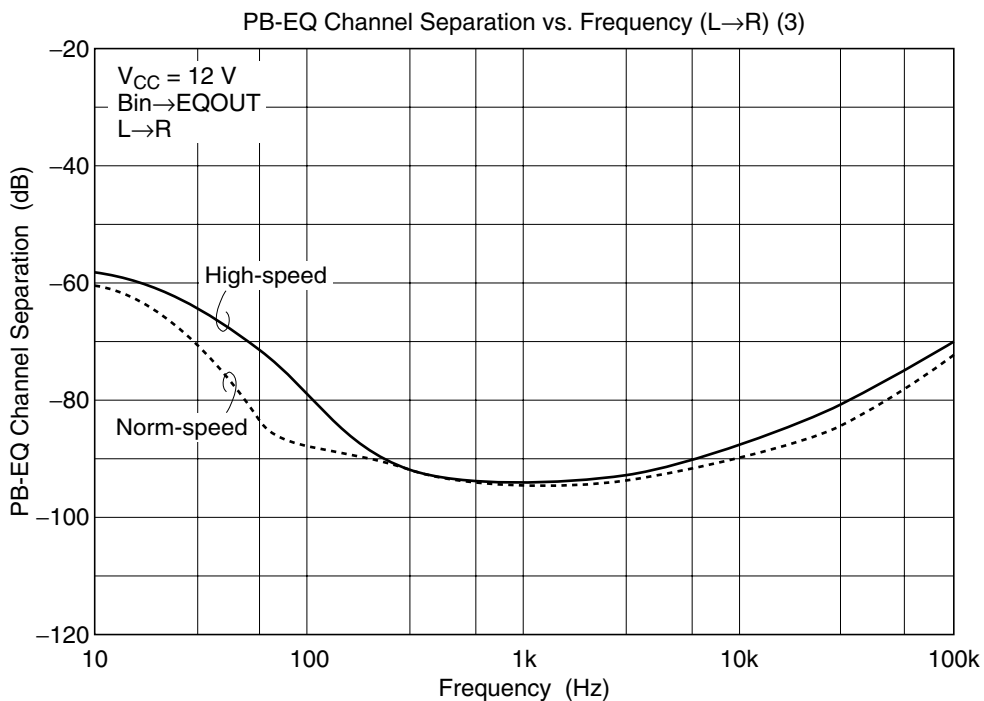
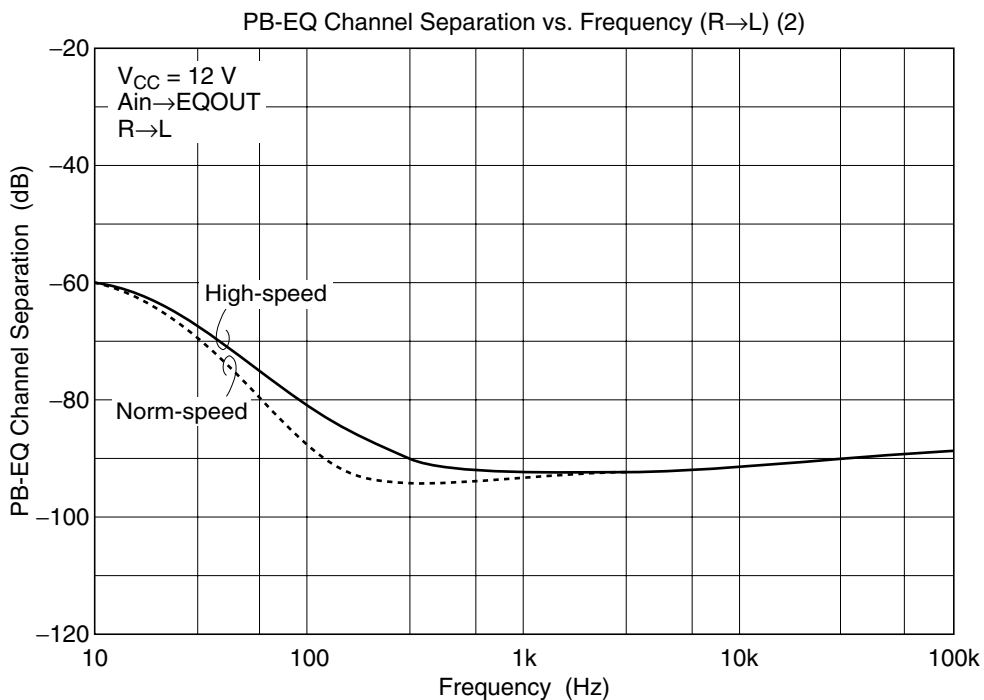

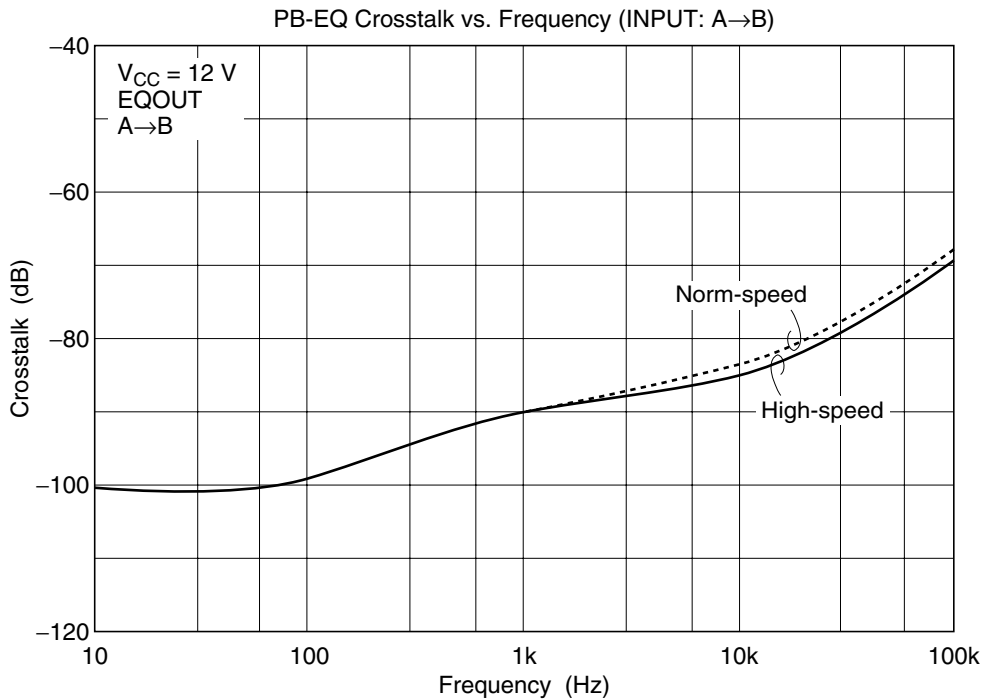
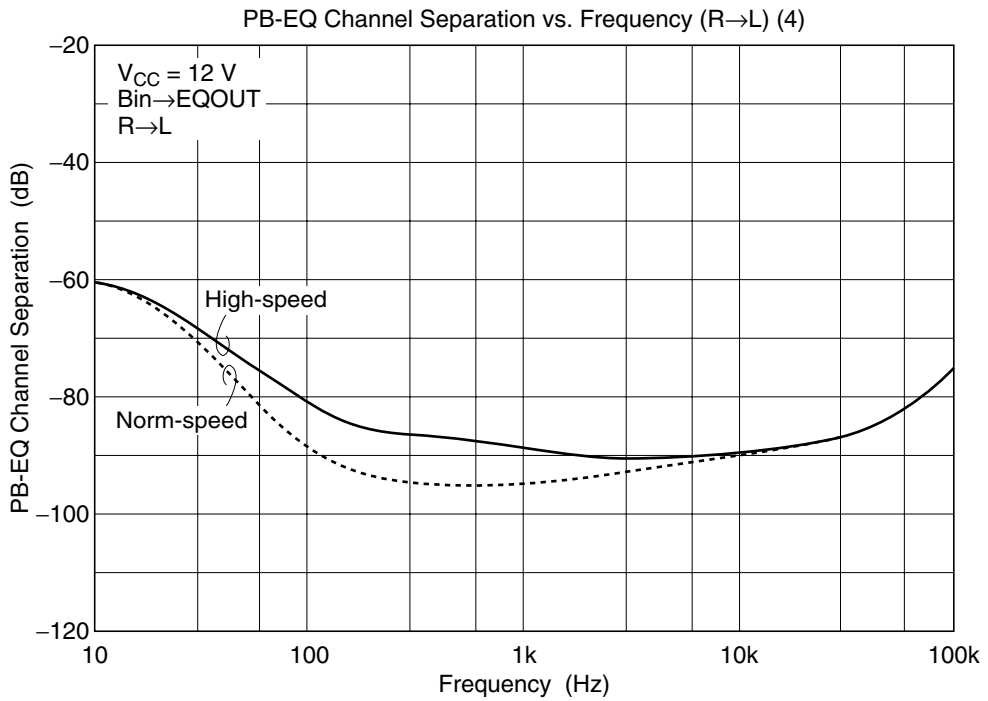



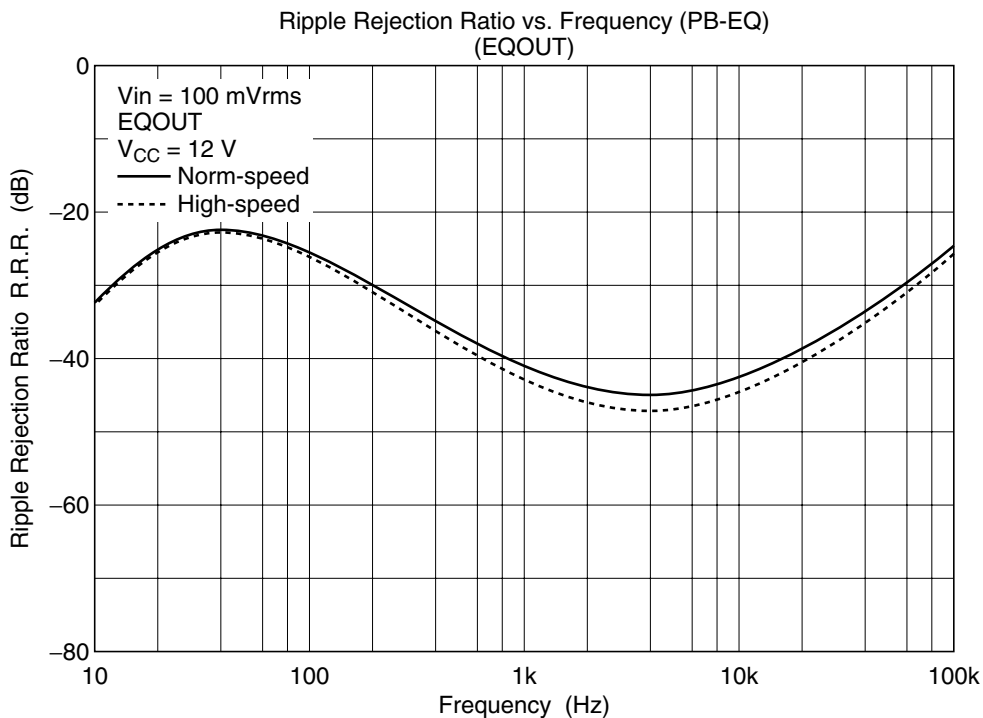
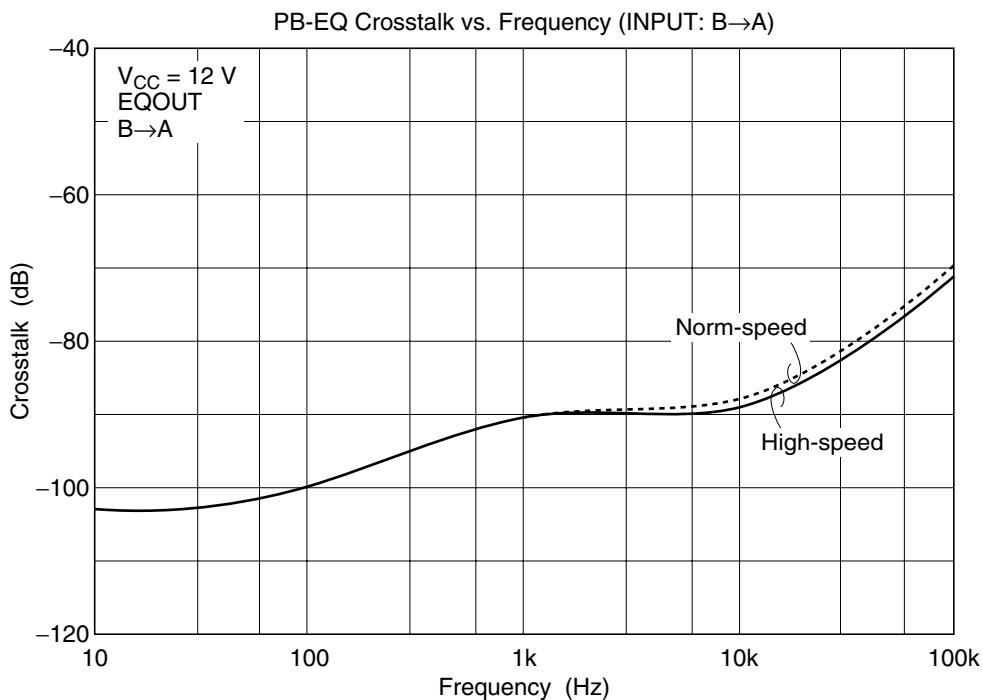

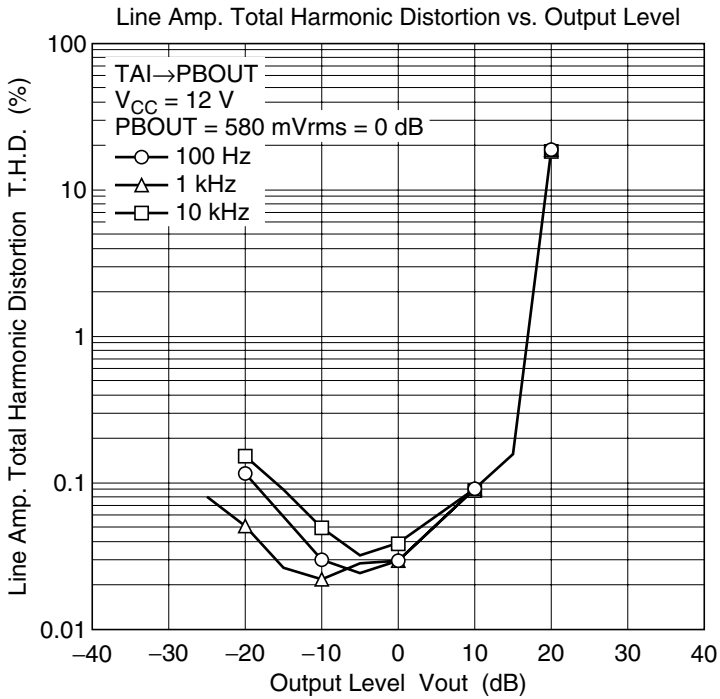
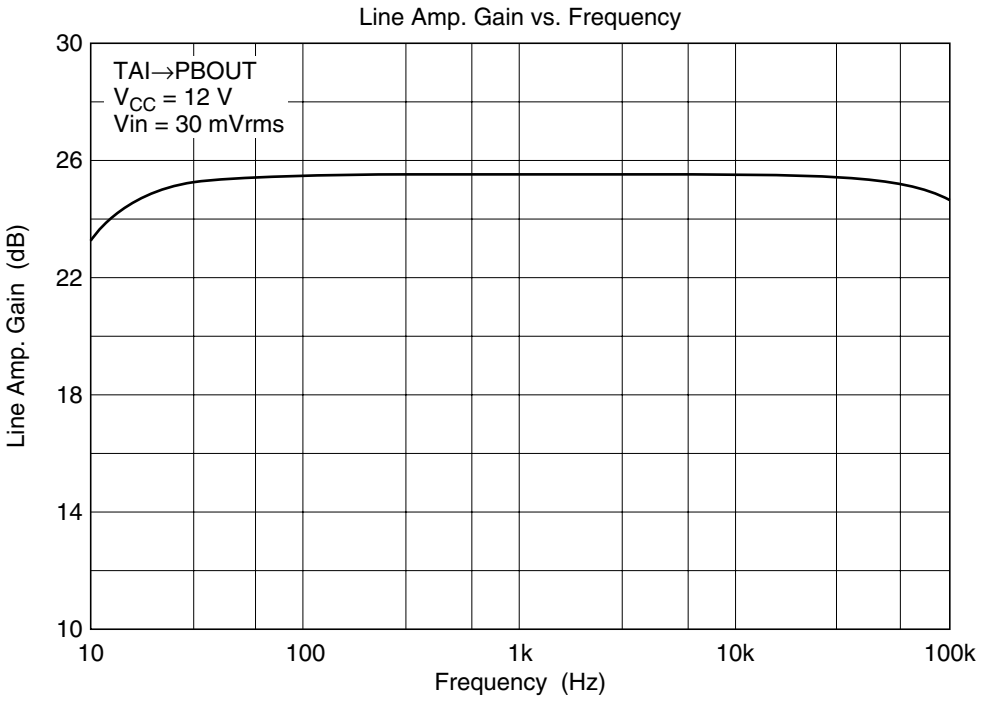

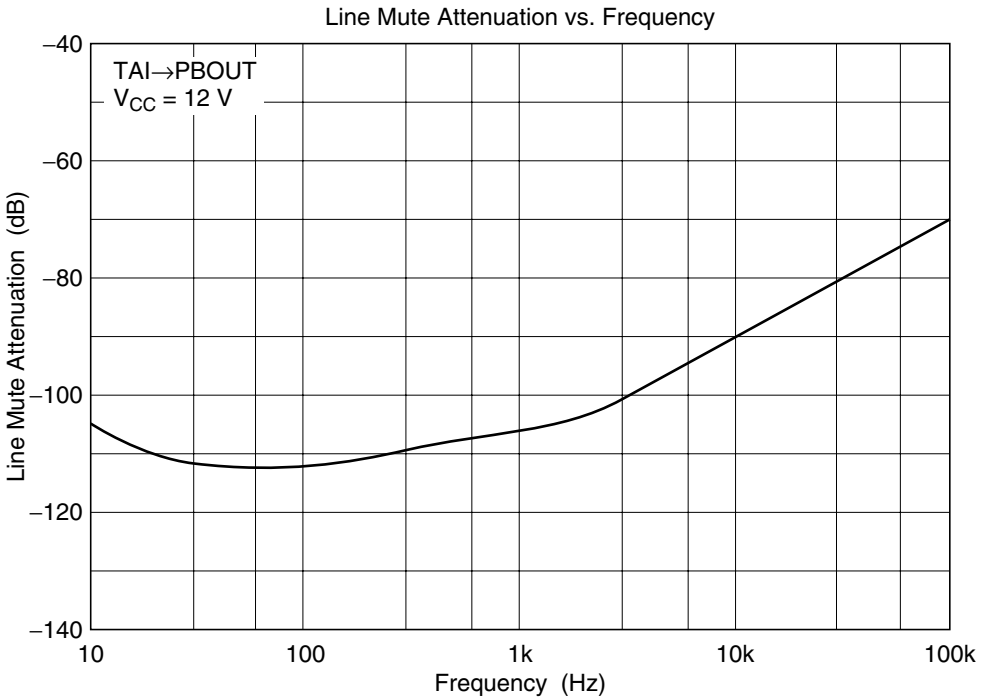
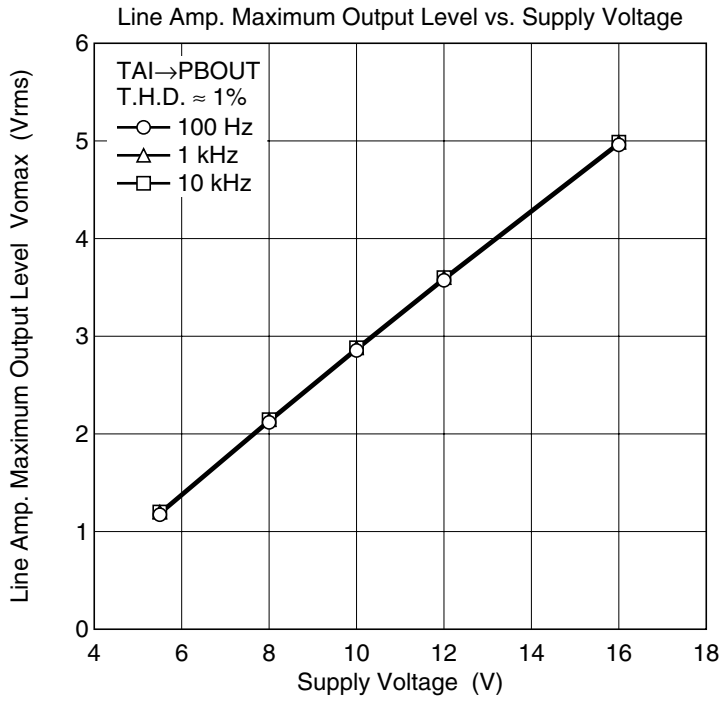

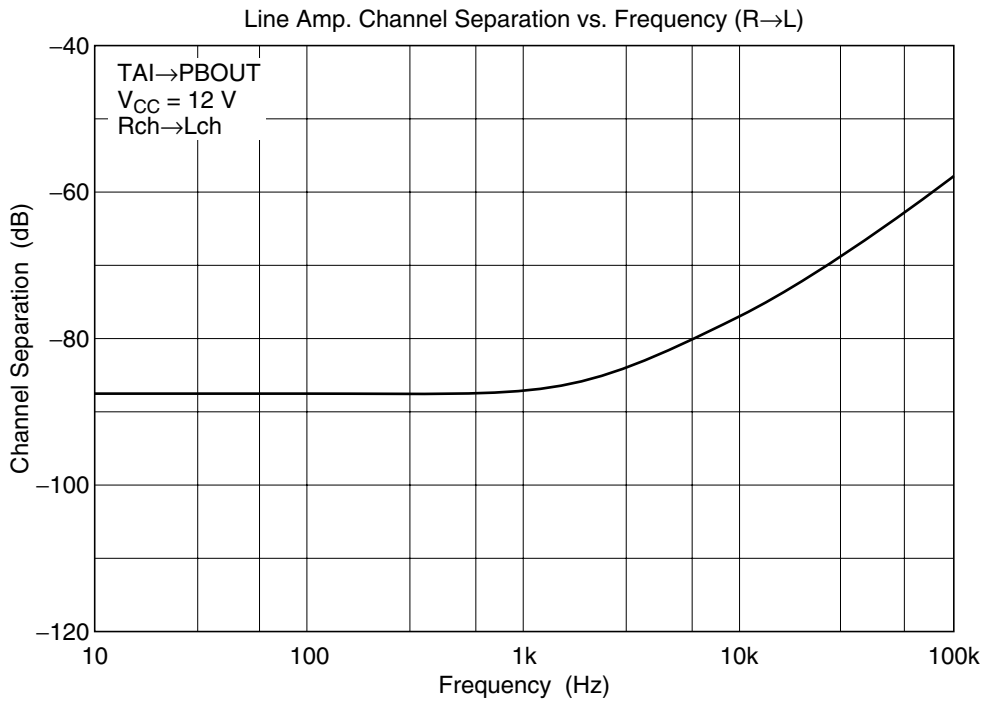
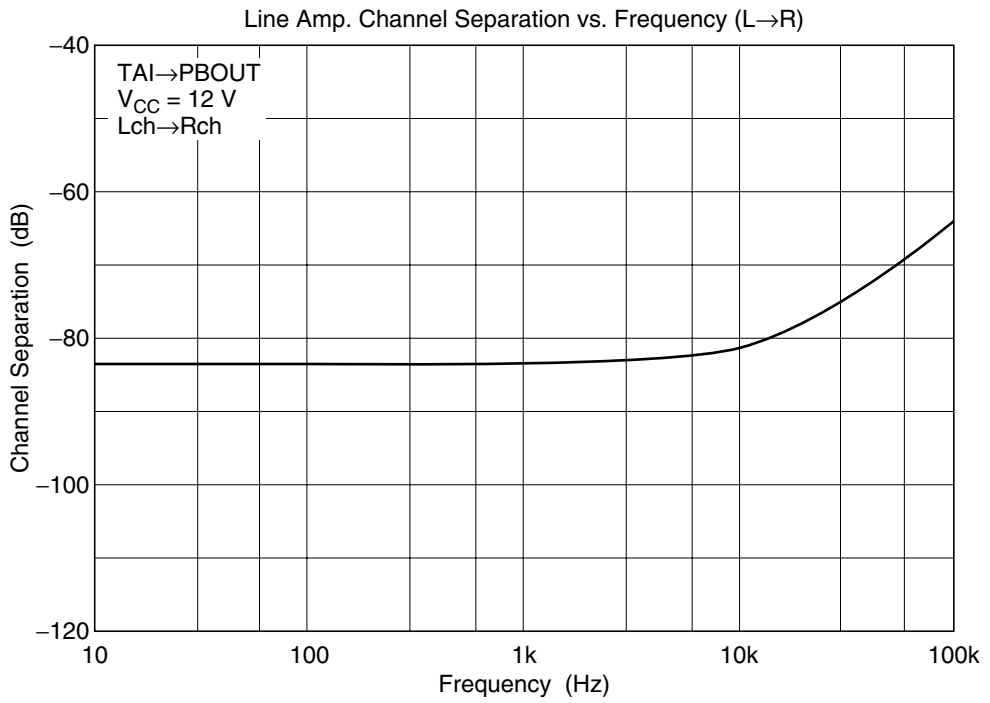

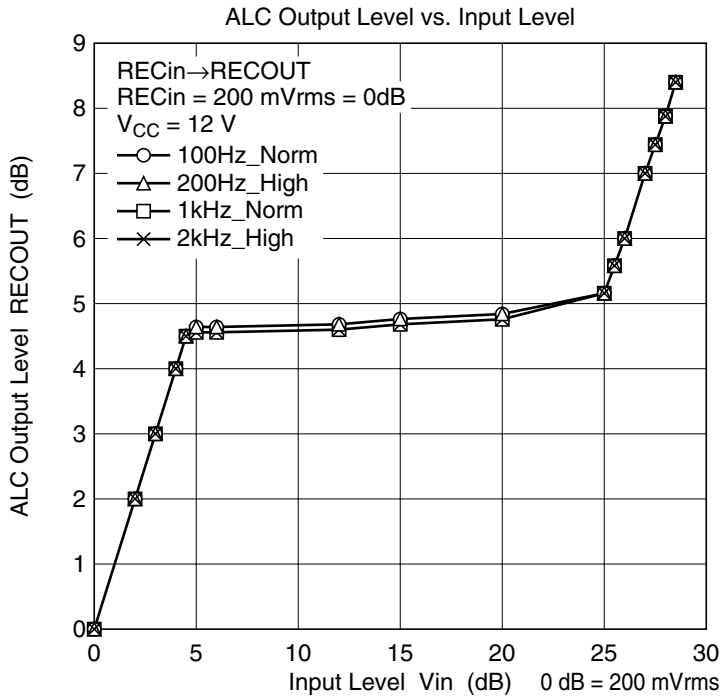
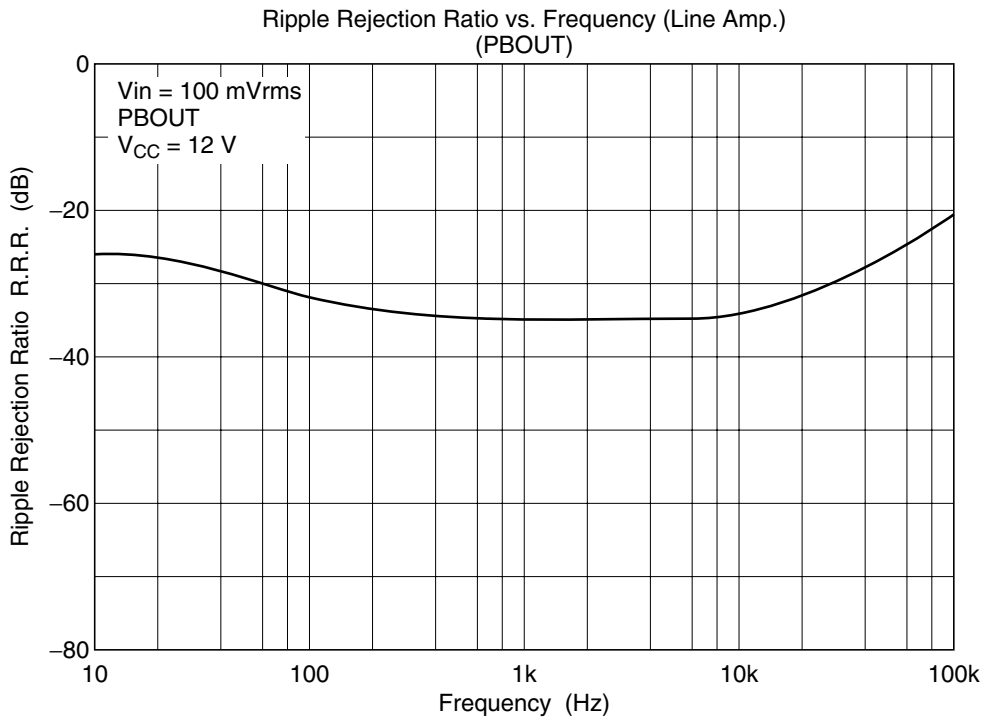

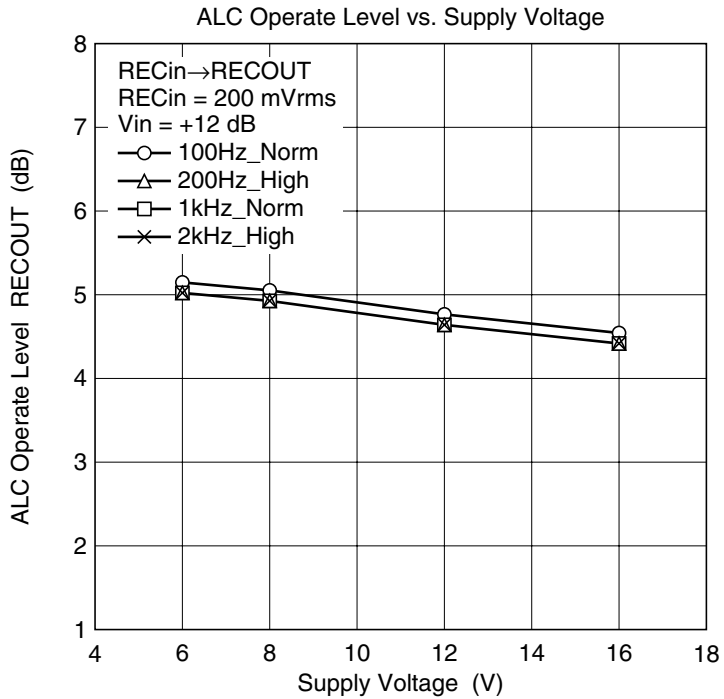
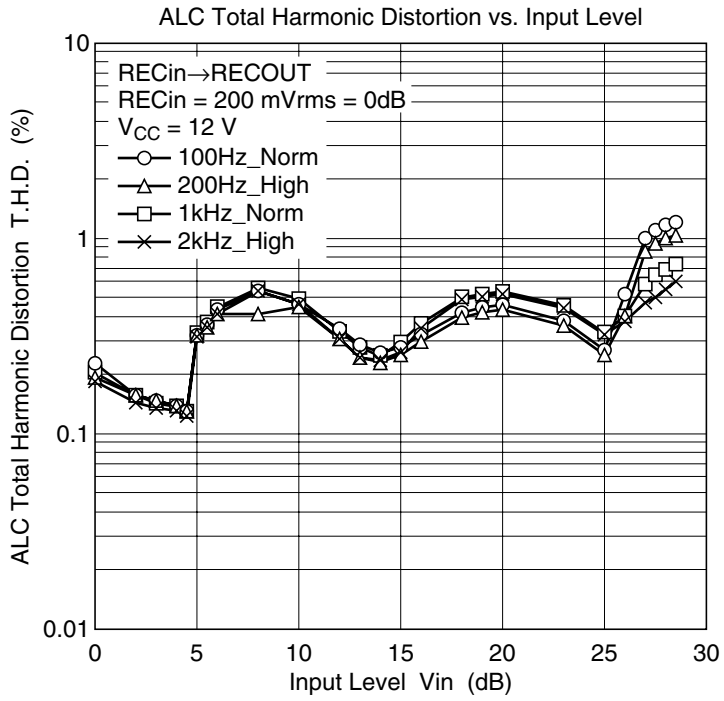

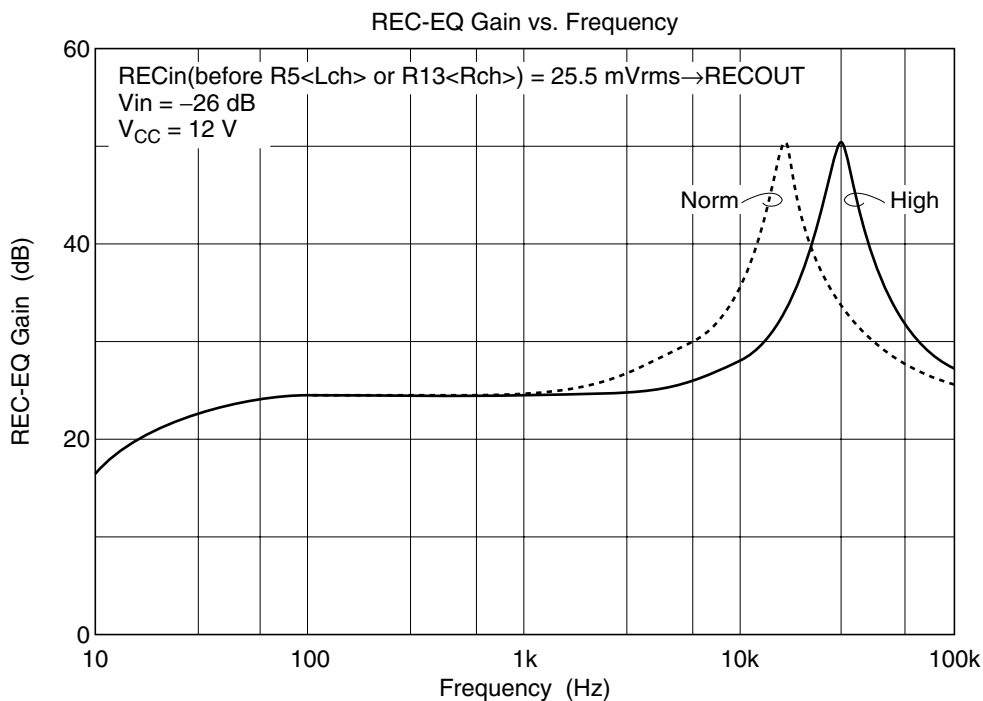
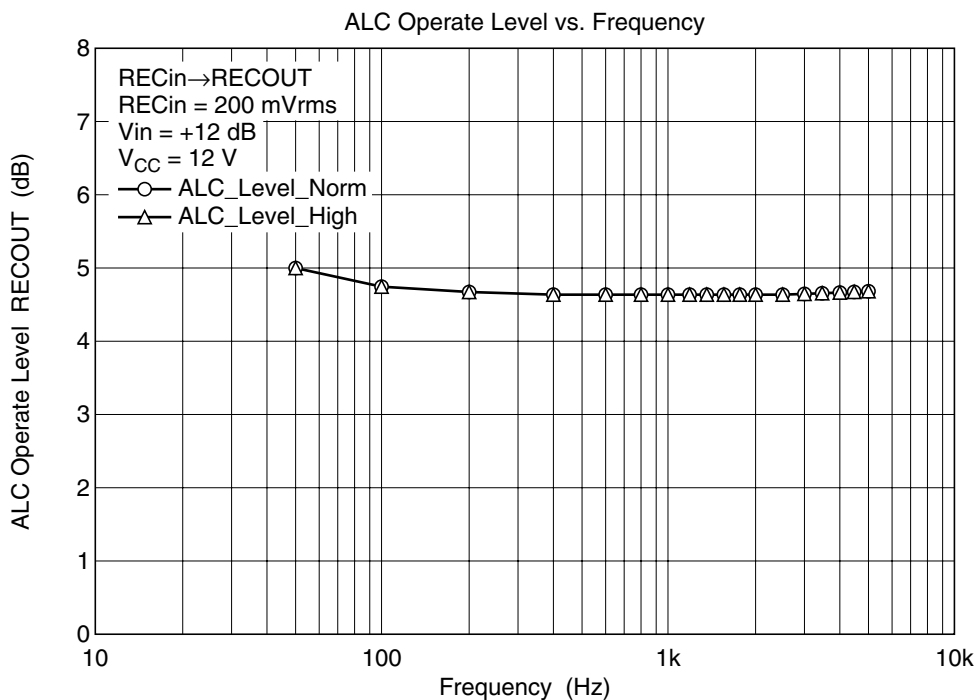

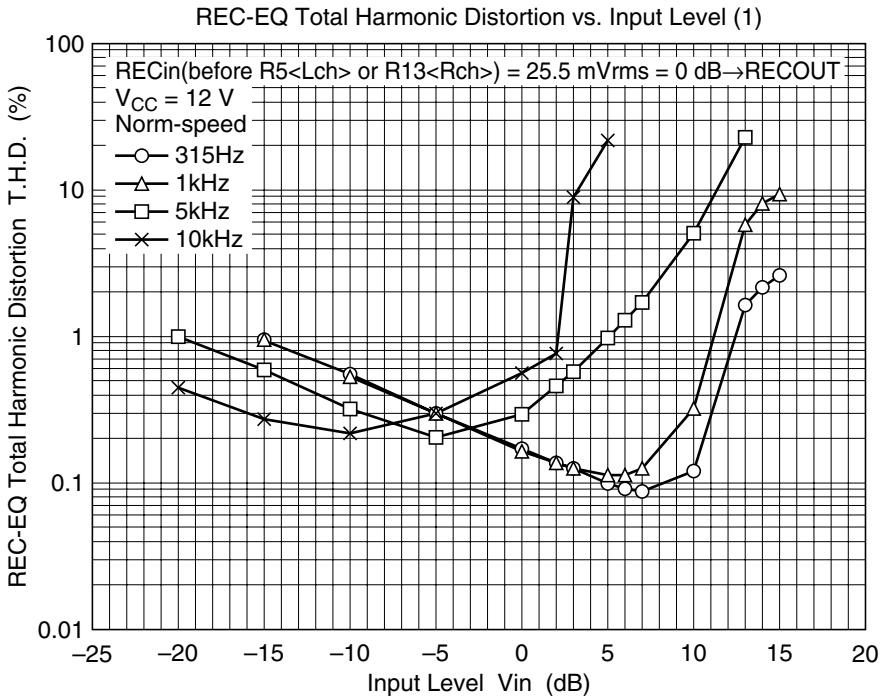
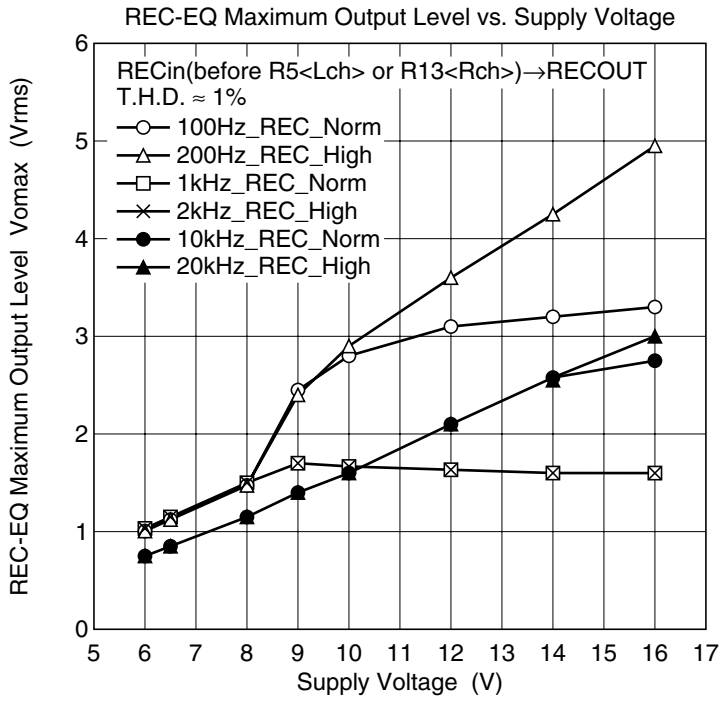



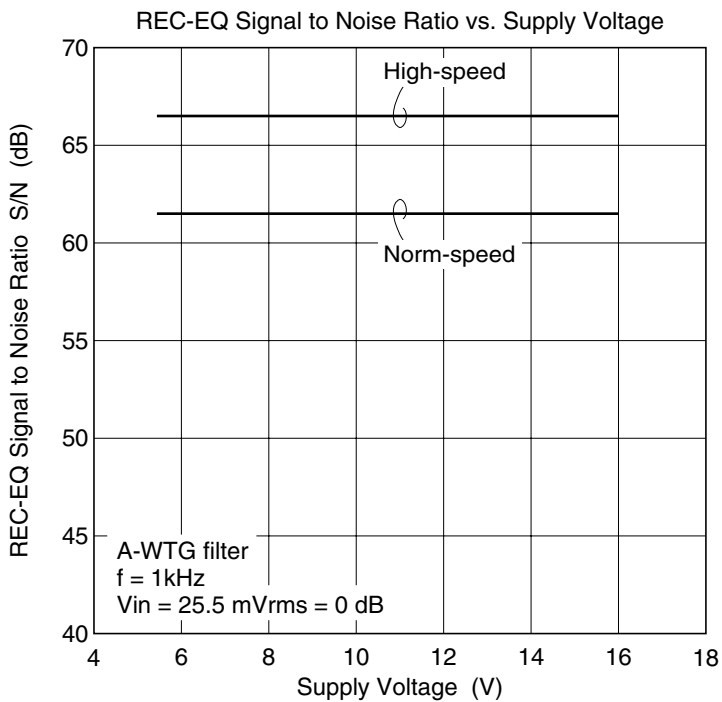
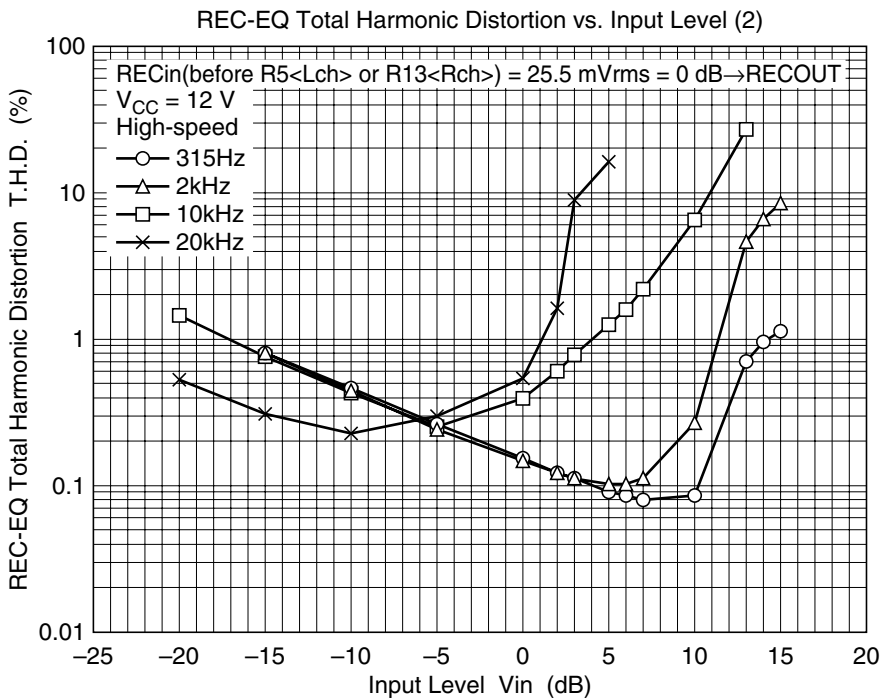

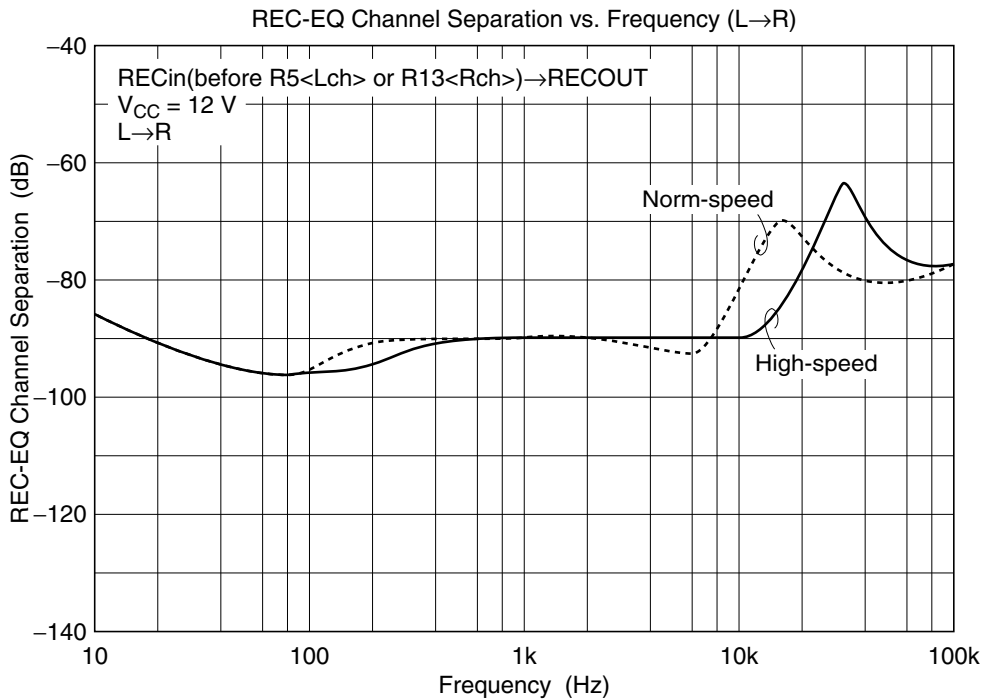
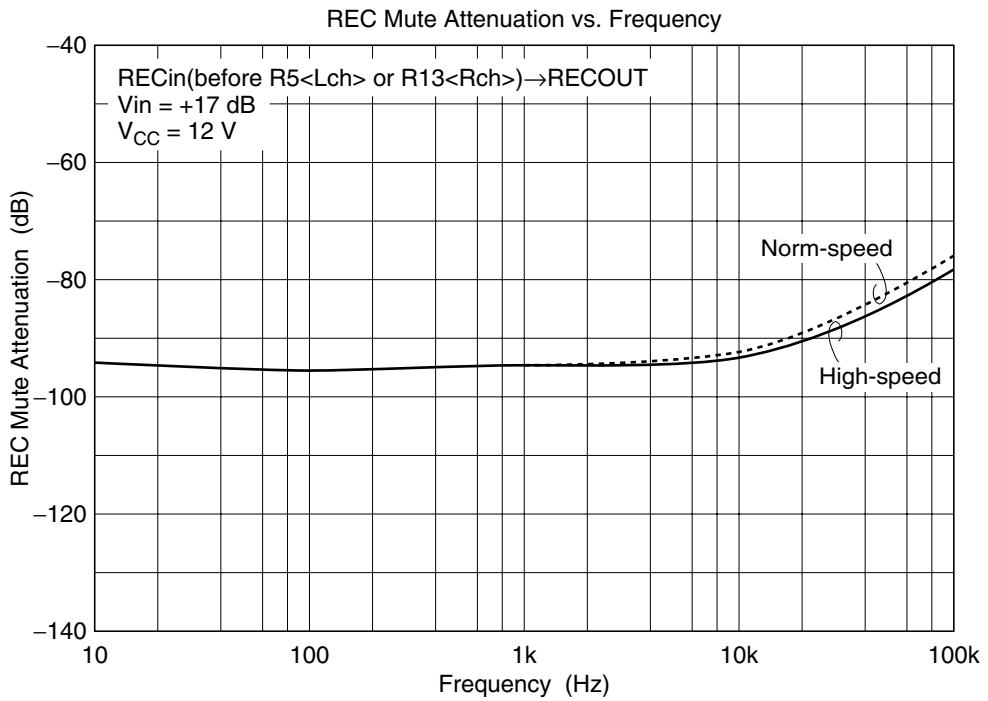

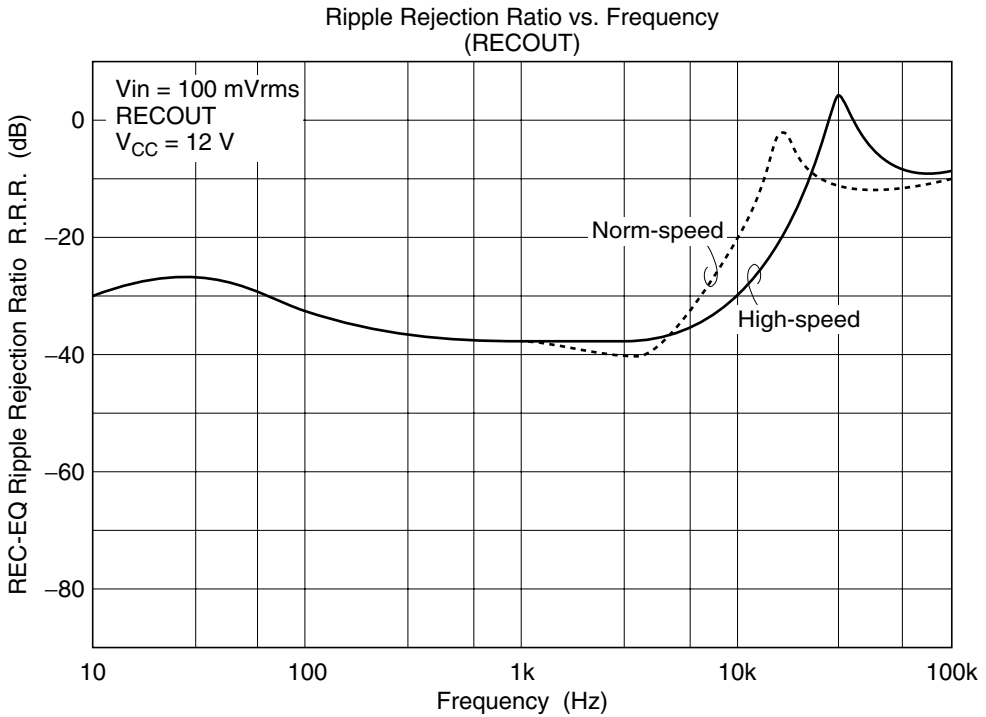
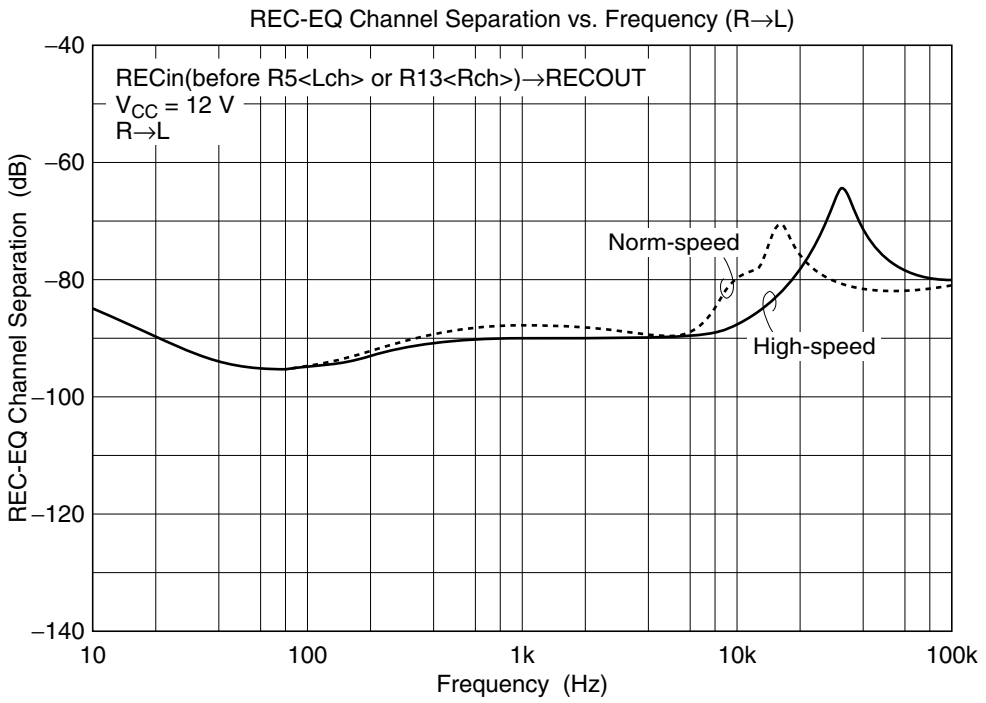

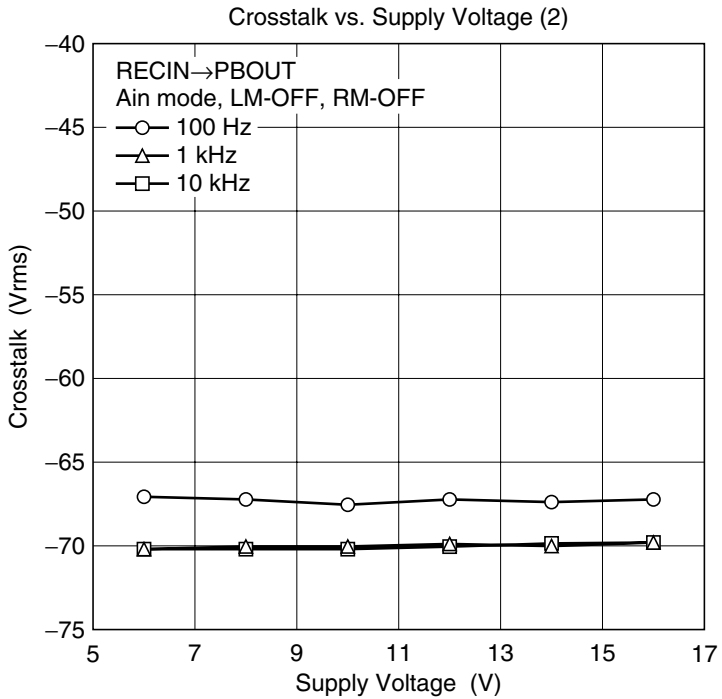
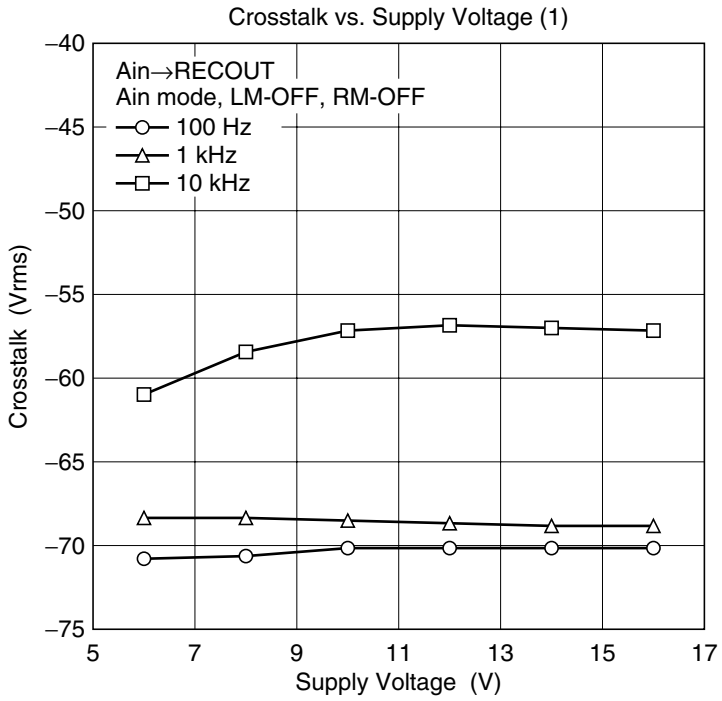

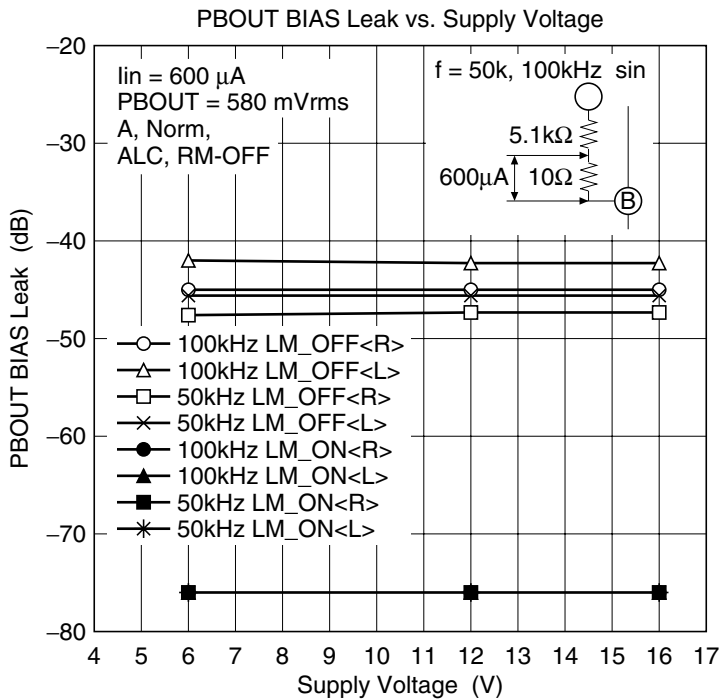
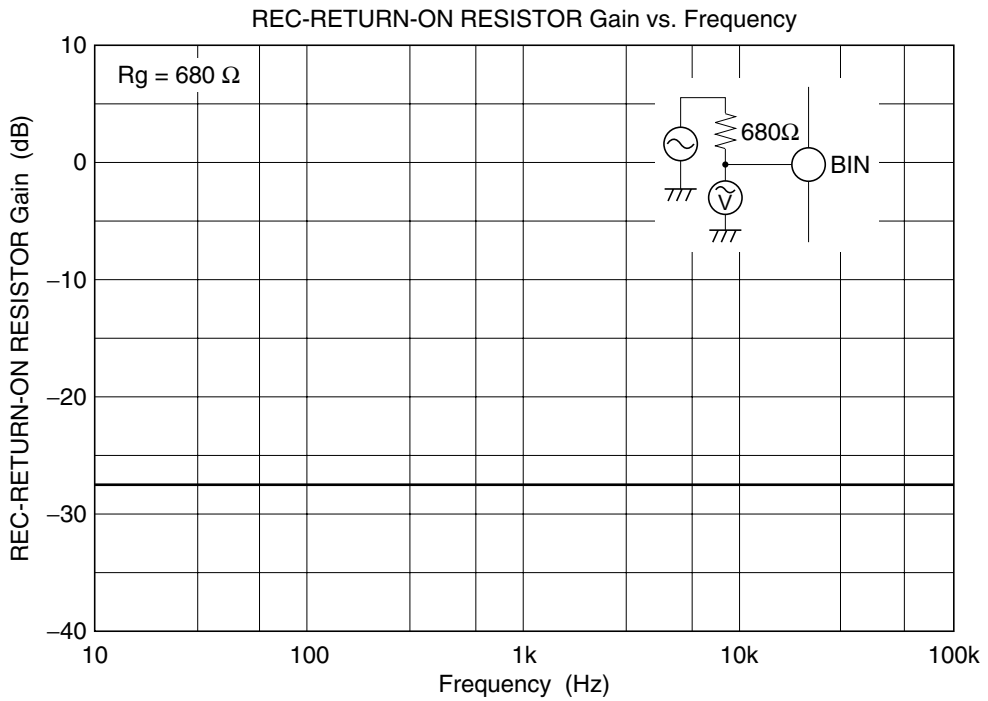

## Package Dimensions

As of July, 2001

Unit: mm

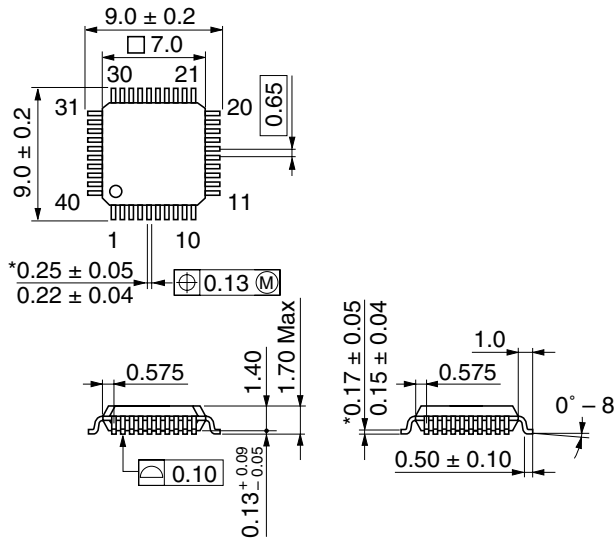

\*Dimension including the plating thickness  
Base material dimension

Hitachi Code	FP-40B
JEDEC	—
JEITA	Conforms
Mass (reference value)	0.2 g

## Disclaimer

1. Hitachi neither warrants nor grants licenses of any rights of Hitachi's or any third party's patent, copyright, trademark, or other intellectual property rights for information contained in this document. Hitachi bears no responsibility for problems that may arise with third party's rights, including intellectual property rights, in connection with use of the information contained in this document.
2. Products and product specifications may be subject to change without notice. Confirm that you have received the latest product standards or specifications before final design, purchase or use.
3. Hitachi makes every attempt to ensure that its products are of high quality and reliability. However, contact Hitachi's sales office before using the product in an application that demands especially high quality and reliability or where its failure or malfunction may directly threaten human life or cause risk of bodily injury, such as aerospace, aeronautics, nuclear power, combustion control, transportation, traffic, safety equipment or medical equipment for life support.
4. Design your application so that the product is used within the ranges guaranteed by Hitachi particularly for maximum rating, operating supply voltage range, heat radiation characteristics, installation conditions and other characteristics. Hitachi bears no responsibility for failure or damage when used beyond the guaranteed ranges. Even within the guaranteed ranges, consider normally foreseeable failure rates or failure modes in semiconductor devices and employ systemic measures such as fail-safes, so that the equipment incorporating Hitachi product does not cause bodily injury, fire or other consequential damage due to operation of the Hitachi product.
5. This product is not designed to be radiation resistant.
6. No one is permitted to reproduce or duplicate, in any form, the whole or part of this document without written approval from Hitachi.
7. Contact Hitachi's sales office for any questions regarding this document or Hitachi semiconductor products.

## Sales Offices

# HITACHI

### Hitachi, Ltd.

Semiconductor & Integrated Circuits  
Nippon Bldg., 2-6-2, Ohte-machi, Chiyoda-ku, Tokyo 100-0004, Japan  
Tel: <03> 3270-2111 Fax: <03> 3270-5109

URL <http://www.hitachisemiconductor.com/>

### For further information write to:

Hitachi Semiconductor (America) Inc.  
179 East Tasman Drive  
San Jose, CA 95134  
Tel: <1> (408) 433-1990  
Fax: <1> (408) 433-0223

Hitachi Europe Ltd.  
Electronic Components Group  
Whitebrook Park  
Lower Cookham Road  
Maidenhead  
Berkshire SL6 8YA, United Kingdom  
Tel: <44> (1628) 585000  
Fax: <44> (1628) 585200

Hitachi Europe GmbH  
Electronic Components Group  
Dornacher Straße 3  
D-85622 Feldkirchen  
Postfach 201, D-85619 Feldkirchen  
Germany  
Tel: <49> (89) 9 9180-0  
Fax: <49> (89) 9 29 30 00

Hitachi Asia Ltd.  
Hitachi Tower  
16 Collyer Quay #20-00  
Singapore 049318  
Tel: <65>-538-6533/538-8577  
Fax: <65>-538-6933/538-3877  
URL: <http://semiconductor.hitachi.com.sg>

Hitachi Asia Ltd.  
(Taipei Branch Office)  
4/F, No. 167, Tun Hwa North Road  
Hung-Kuo Building  
Taipei (105), Taiwan  
Tel: <886>-(2)-2718-3666  
Fax: <886>-(2)-2718-8180  
Telex: 23222 HAS-TP  
URL: <http://www.hitachi.com.tw>

Hitachi Asia (Hong Kong) Ltd.  
Group III (Electronic Components)  
7/F., North Tower  
World Finance Centre,  
Harbour City, Canton Road  
Tsim Sha Tsui, Kowloon Hong Kong  
Tel: <852>-(2)-735-9218  
Fax: <852>-(2)-730-0281  
URL: <http://semiconductor.hitachi.com.hk>

Copyright © Hitachi, Ltd., 2002. All rights reserved. Printed in Japan.

Colophon 5.0