HA12192F/HA12197F/HA12212F Series

Audio Signal Processor for Car Deck
(Decode only Dolby B-type NR with PB Amp.)

HITACHI

ADE-207-167D (Z)

5th Edition
Jun. 1999

Description

HA12192F/HA12197F/HA12212F series are silicon monolithic bipolar ICs providing Dolby noise reduction system*, music sensor, PB equalizer system in one chip.

Functions

- PB equalizer × 2 channel
- Music sensor × 1 channel
- Decode only Dolby B-NR × 2 channel

Note: HA12197F series is not built in Dolby B-NR.

Features

- Different type of PB equalizer characteristics selection (120 μ / 70 μ position) is available with fully electronic control switching built-in.
- Changeable to Forward, Reverse-mode for PB head with fully electronic control switching built-in.
- Available to change music sensing level by external resistor.
- Available to change frequency response of music sensor by external capacitor.
- NR ON/OFF fully electronic control switching built-in. (HA12192F/HA12212F series only)
- Available to connect direct with MPU.
- HA12192F series, HA12197F series and HA12212F available to allow common PCB designs.
- HA12212F only changes by package from HA12192F series. It is the same electrical characteristics that HA12192F series.

* Dolby is a trademark of Dolby Laboratories Licensing Corporation.
A license from Dolby Laboratories Licensing Corporation is required for the use of this IC.

HA12192F/HA12197F/HA12212F Series

Ordering Information

Product	Package	PB-OUT Level	Function			Operating Voltage	
			PB-EQ	Dolby B-NR	MS	Min	Max
HA12192F	FP-28TB	300mVrms	○	○	○	6.5V	15V
HA12197F			○	×	○		
HA12193F		387.5mVrms	○	○	○	6.8V	
HA12198F			○	×	○		
HA12194F		450mVrms	○	○	○	7.2V	
HA12199F			○	×	○		
HA12212F	FP-40B	300mVrms	○	○	○	6.5V	

Note: These ICs are designed to operate on single supply.

HA12192F/HA12197F/HA12212F Series

Pin Description and Equivalent Circuit ($V_{CC} = 9V$, single supply, $T_a = 25^\circ C$, No signal, The value in the table show typical value.)

Pin No.

FP-28TB	FP-40B	Pin Name	Note	Equivalent Circuit	Description																		
13	19	MSI	$V = V_{CC} / 2$		MS input *1 <table border="1" style="margin-left: auto; margin-right: auto;"> <thead> <tr> <th></th> <th>Ri1</th> <th>Ri2</th> </tr> </thead> <tbody> <tr> <td>HA12192/3/4</td> <td>0</td> <td>100k</td> </tr> <tr> <td>HA12212F</td> <td></td> <td></td> </tr> <tr> <td>HA12197</td> <td></td> <td></td> </tr> <tr> <td>HA12198</td> <td>22.6k</td> <td>77.4k</td> </tr> <tr> <td>HA12199</td> <td>33.3k</td> <td>66.7k</td> </tr> </tbody> </table>		Ri1	Ri2	HA12192/3/4	0	100k	HA12212F			HA12197			HA12198	22.6k	77.4k	HA12199	33.3k	66.7k
	Ri1	Ri2																					
HA12192/3/4	0	100k																					
HA12212F																							
HA12197																							
HA12198	22.6k	77.4k																					
HA12199	33.3k	66.7k																					
18	28	DIN (L)	$V = V_{CC} / 2$		Deck input																		
3	3	DIN (R)																					
16 *2	22	DET (L)	$V = 2.5V$		Time constant pin for rectifier																		
5 *2	9	DET (R)																					
23	33	RIP	$V = V_{CC} / 2$		Ripple filter																		
6 *2	10	BIAS	$V = 0.28V$		Dolby bias current input																		

- Note:
1. MS : Music Sensor
 2. Non connection regarding HA12197F series.

HA12192F/HA12197F/HA12212F Series

Pin Description and Equivalent Circuit ($V_{CC} = 9V$, single supply, $T_a = 25^\circ C$, No signal, The value in the table show typical value.) (cont)

Pin No.

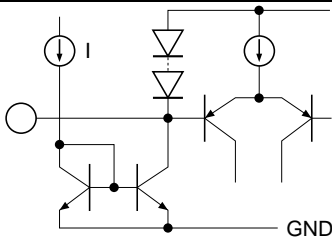
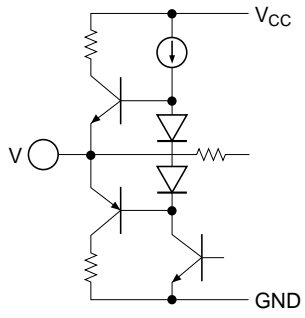
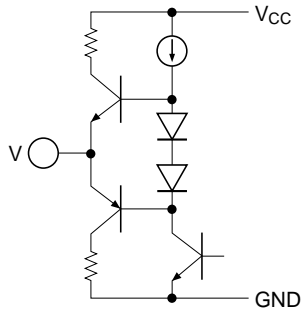
FP-28TB	FP-40B	Pin Name	Note	Equivalent Circuit	Description
12	18	MSDET	$I = 0\mu A$		Time constant pin for rectifier
17	23	PBOUT (L)	$V = V_{CC} / 2$		PB output
4	8	PBOUT (R)			
14	20	MAOUT	$V = V_{CC} / 2$		MS amp. output *1
26	38	VREF			Reference output
19	29	EQOUT (L)			Equalizer output
2	2	EQOUT (R)			(120μ)

Note: 1. MS : Music Sensor

HA12192F/HA12197F/HA12212F Series

Pin Description and Equivalent Circuit ($V_{CC} = 9V$, single supply, $T_a = 25^\circ C$, No signal, The value in the table show typical value.) (cont)

Pin No.

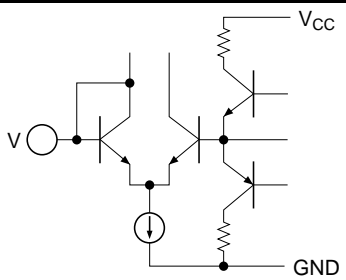
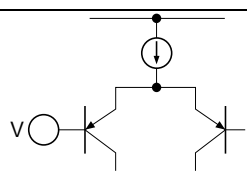
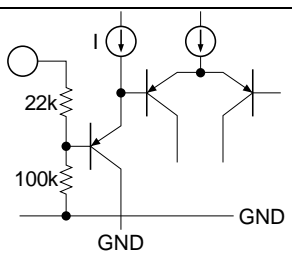
FP-28TB	FP-40B	Pin Name	Note	Equivalent Circuit	Description
20	30	M-OUT (L)	$V = V_{CC} / 2$		Equalizer output (70 μ)
1	1	M-OUT (R)			
11	17	V_{CC}	$V = V_{CC}$		Power supply
—	35, 36	TAB	$V = 0V$		GND pin
—	4,5,6,7, 15,16,24, 25,26,27	—	—		NC pin
24	34	FIN (L)	$V = V_{CC} / 2$		Equalizer input (FORWARD)
25	37	FIN (R)			
22	32	RIN (L)			Equalizer input
27	39	RIN (R)			(REVERSE)
21	31	NFI (L)			Negative feedback
28	40	NFI (R)			
7 *1	11	NR OFF / ON	$I = 20\mu A$		Mode control input
8	12	120 / 70			
9	13	F / R			

Note: 1. Non connection regarding HA12197F series.

HA12192F/HA12197F/HA12212F Series

Pin Description and Equivalent Circuit ($V_{cc} = 9V$, single supply, $T_a = 25^\circ C$, No signal, The value in the table show typical value.) (cont)

Pin No.

FP-28TB	FP-40B	Pin Name	Note	Equivalent Circuit	Description
10	14	MSOUT	$I = 0\mu A$		MS output (to MPU) *1
15	21	MSG _v	$V = V_{cc} / 2$		MS gain terminal *1

Note: 1. MS : Music Sensor

HA12192F/HA12197F/HA12212F Series

Block Diagram

HA12192F Series

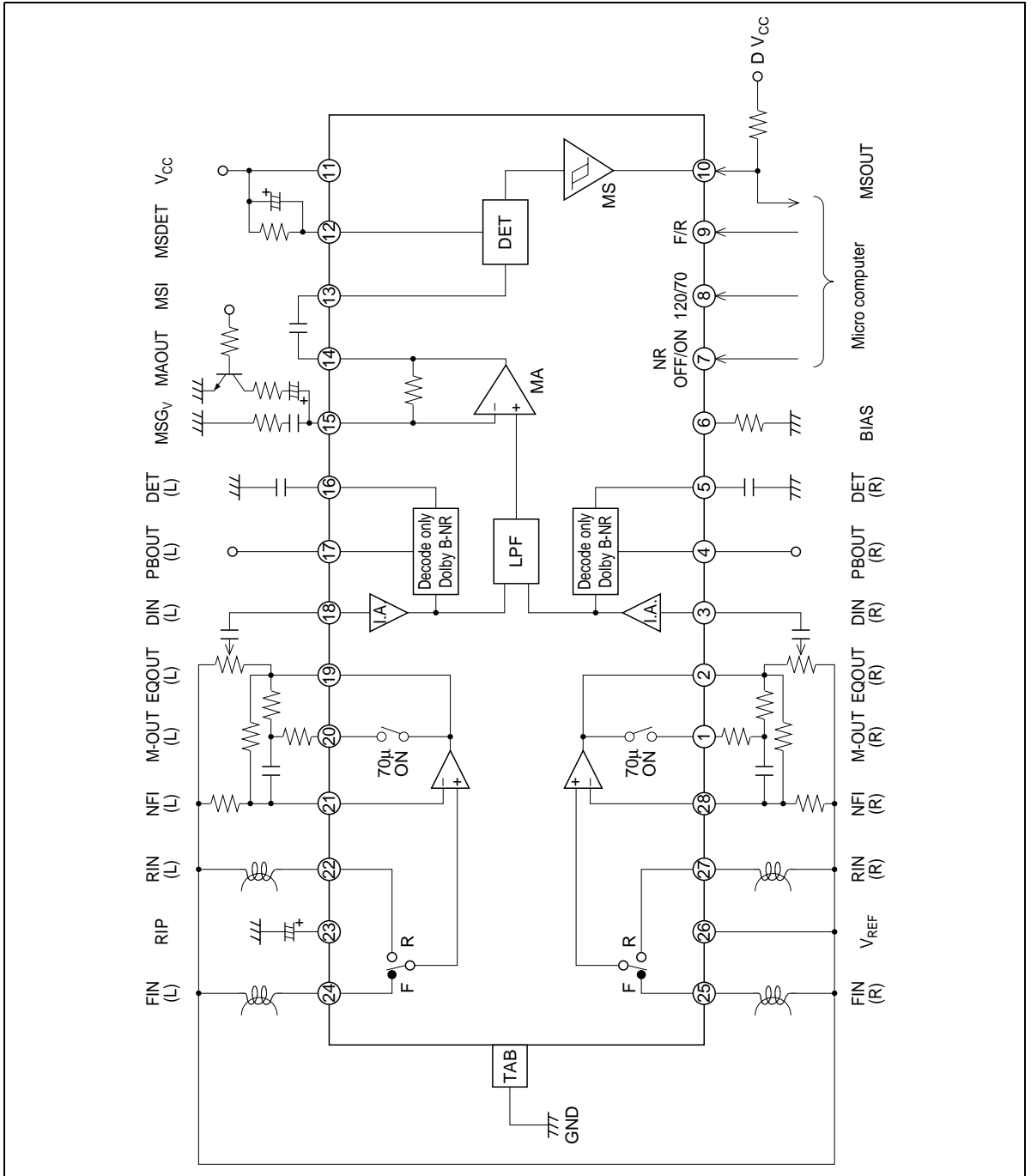

HA12192F/HA12197F/HA12212F Series

HA12197F Series

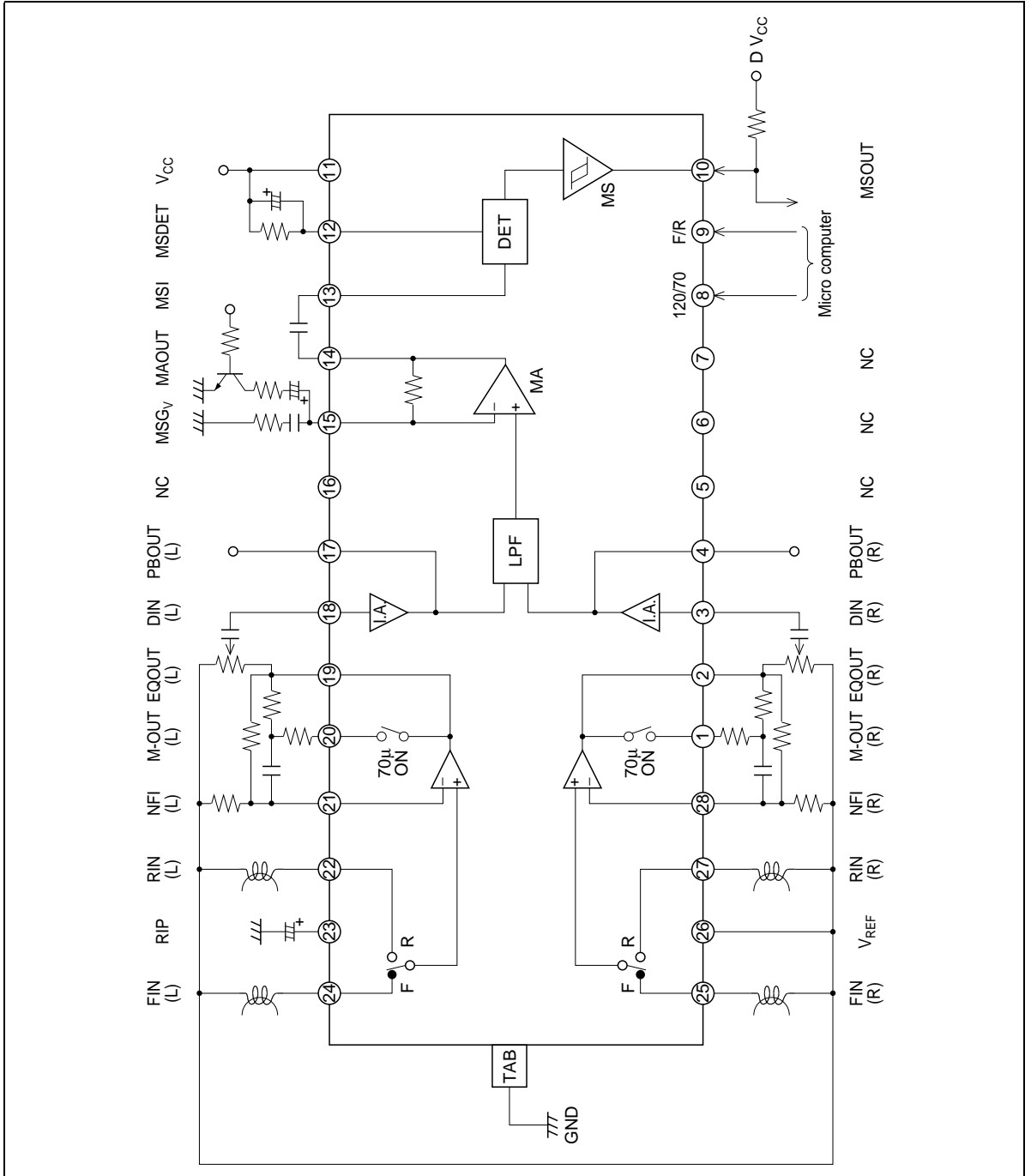

HA12212F

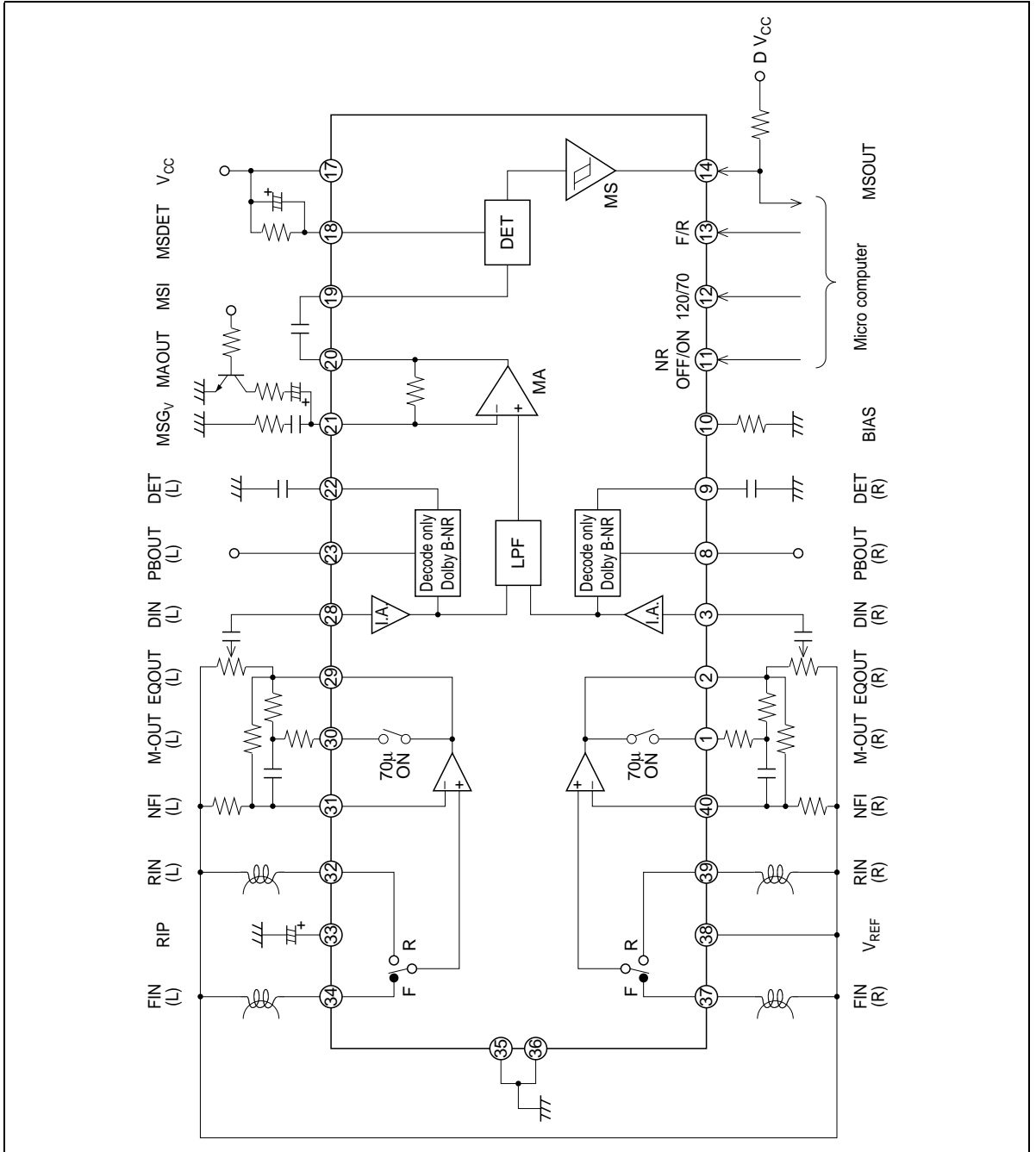

HA12192F/HA12197F/HA12212F Series

Functional Description

Power Supply Range

HA12192F series and HA12197F series are provided with three line output level, which will permit on optimum overload margin for power supply conditions. And these series are designed to operate on single supply only.

Table 1 Supply Voltage Range

Product	Single Supply
HA12192F, HA12197F	6.5V to 15.0V
HA12193F, HA12198F	6.8V to 15.0V
HA12194F, HA12199F	7.2V to 15.0V

Note: The lower limit of supply voltage depends on the line output reference level.
The minimum value of the overload margin is specified as 12dB by Dolby Laboratories.

Reference Voltage

These devices provide the reference voltage of half the supply voltage that is the signal grounds. As the peculiarity of these devices, the capacitor for the ripple filter is very small about 1/100 compared with their usual value. The block diagram is shown as figure 1.

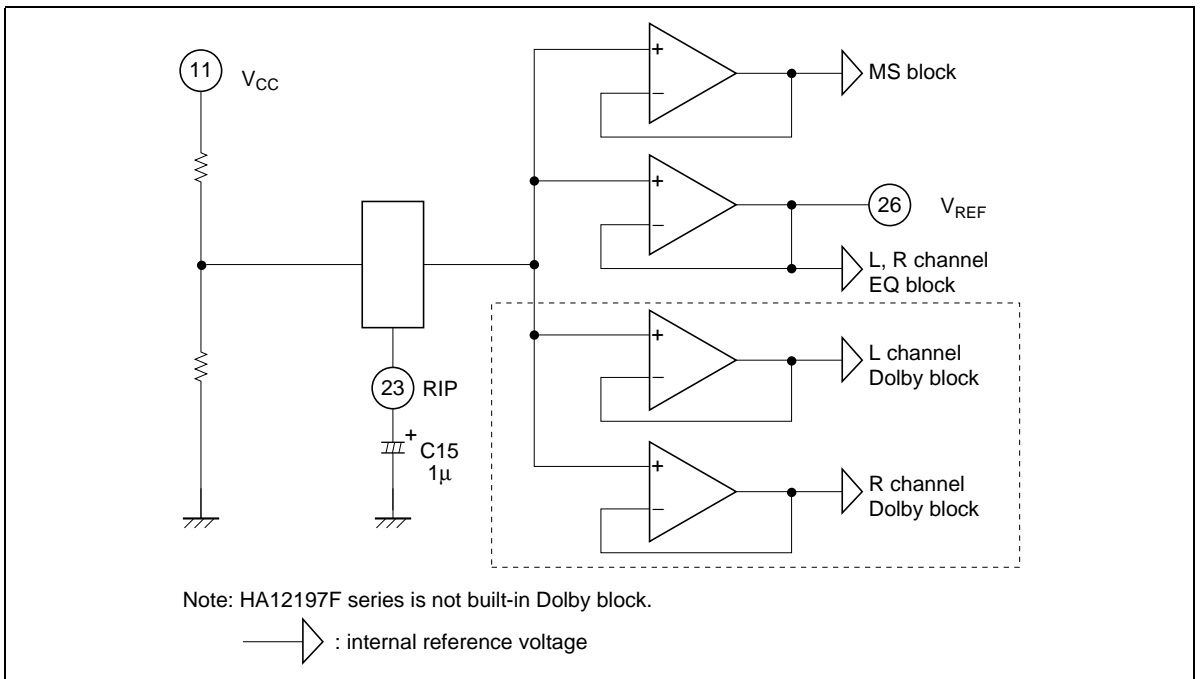

Figure 1 The Block Diagram of Reference Supply Voltage

HA12192F/HA12197F/HA12212F Series

Operating Mode Control

HA12192F series and HA12197F series provides fully electronic switching circuits. And each operating mode control are controlled by parallel data (DC voltage).

Table 2 Threshold Voltage (V_{TH})

Pin No.	Lo	Hi	Unit	Test Condition
7*1, 8, 9	-0.2 to 1.0	3.5 to 5.3	V	

Table 3 Switching Truth Table

Pin No.	Lo	Hi
7*1	NR-OFF	NR-ON
8	120 μ (NORMAL)	70 μ (MATAL or CHROME)
9	FORWARD	REVERSE

*1. Non connection regarding HA12197F series.

- Note:
1. Each pins are on pulled down with 100k Ω internal resistor. Therefore, it will be low-level when each pins are open.
 2. Over shoot level and under shoot level of input signal must be the standardized.
(High: 5.3V, Low: -0.2V)
 3. Reducing pop noise is so much better for 10k Ω to 22k Ω resistor and 1 μ F to 22 μ F capacitor shown figure 2.

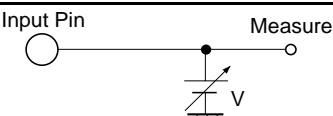
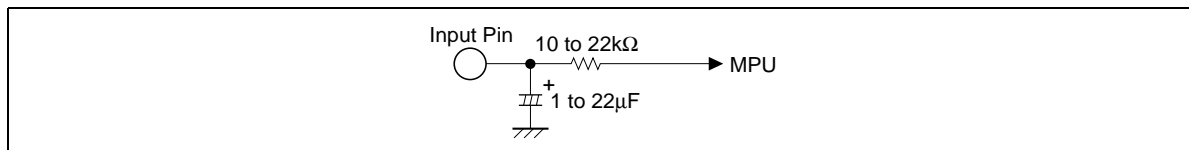

Figure 2 Interface for Reduction of Pop Noise

HA12192F/HA12197F/HA12212F Series

Input Block Diagram and Level Diagram

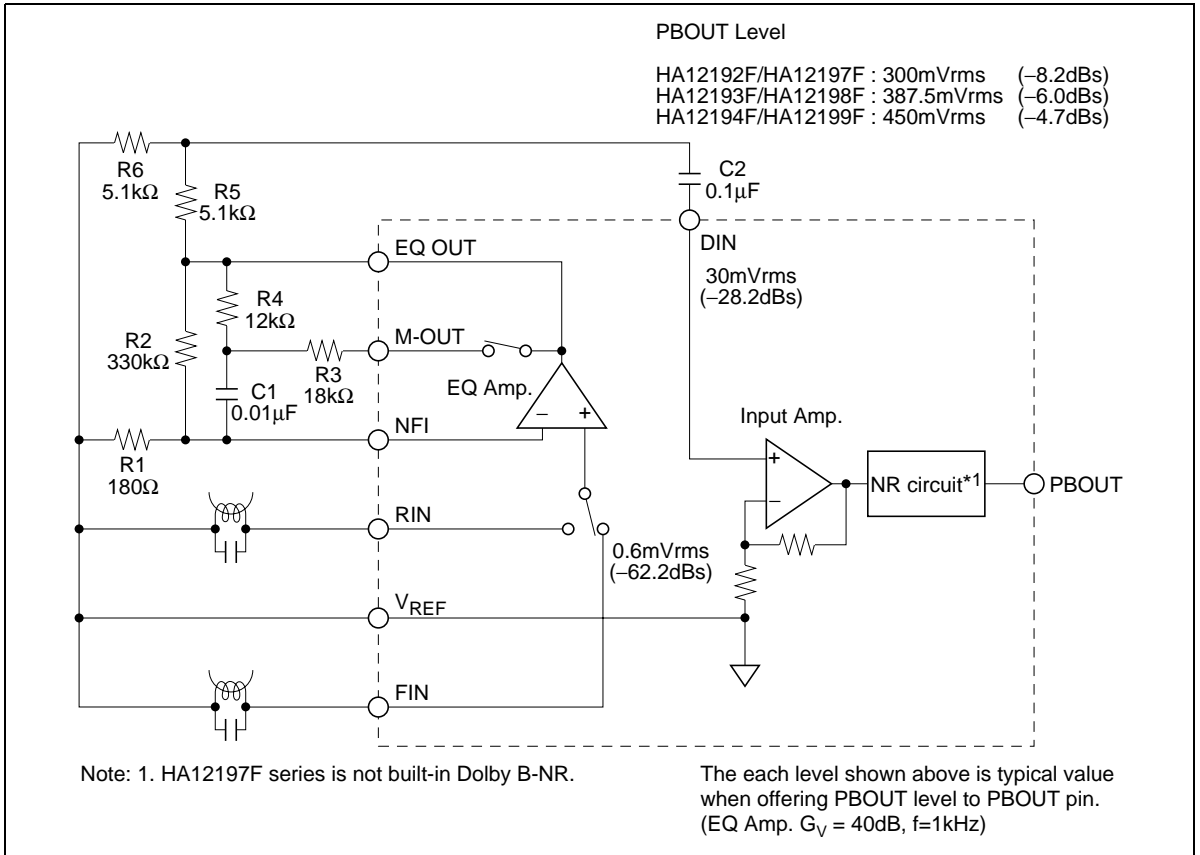

Figure 3 Input Block Diagram

Adjustment of Playback Dolby Level

After replace R5 and R6 with a half-fix volume of 10k Ω , adjust playback Dolby level.

The Sensitivity Adjustment of Music Sensor

Adjusting MS Amp. gain by external resistor, the sensitivity of music sensor can set up.

The music sensor block diagram is shown in figure 4, and frequency response is shown in figure 5.

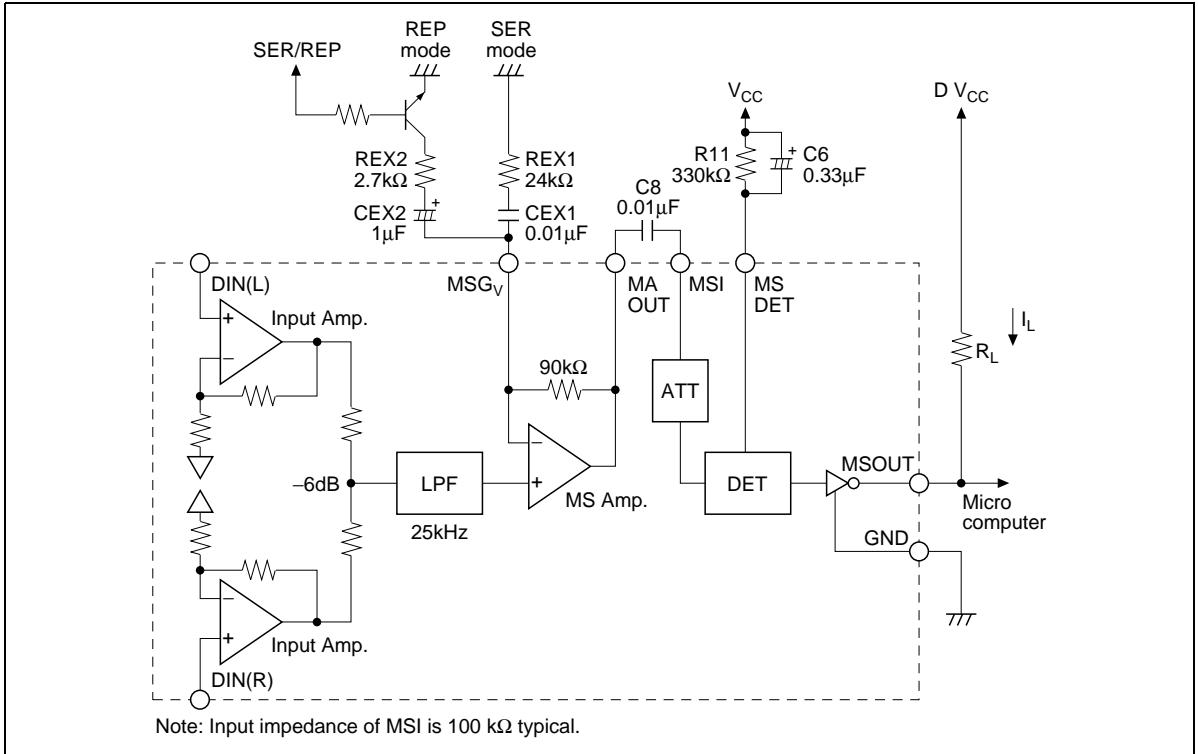

Figure 4 Music Sensor Block Diagram

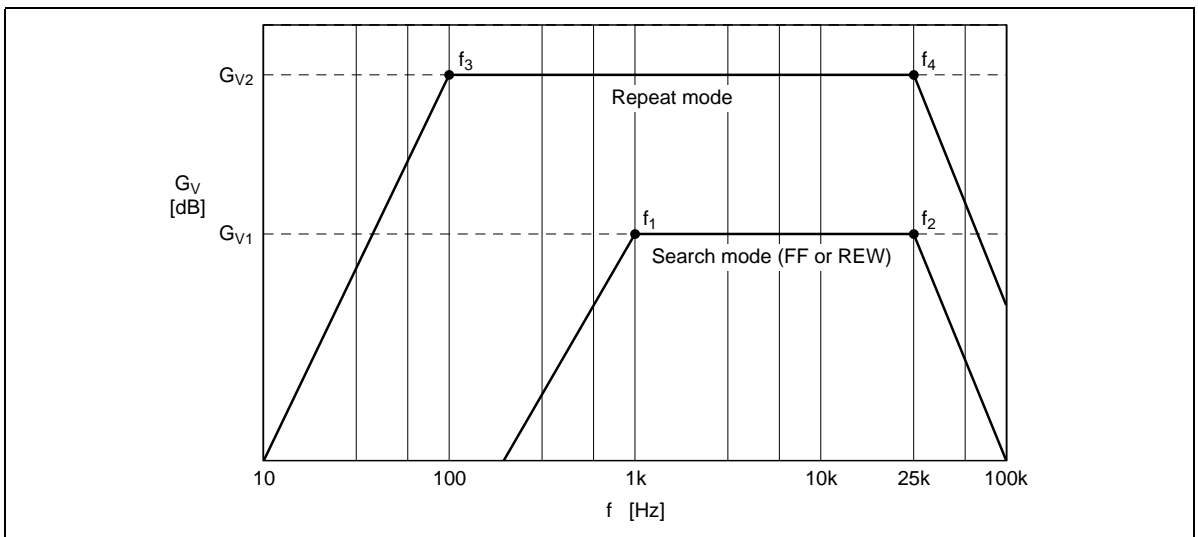

Figure 5 Frequency Response

HA12192F/HA12197F/HA12212F Series

Product	G _{VIA}	ATT	G _{VIA} + ATT
HA12192F series	20dB	0dB	20dB
HA12197F	20dB	0dB	20dB
HA12198F	22.2dB	-2.2dB	20dB
HA12199F	23.5dB	-3.5dB	20dB

1. Search mode (FF or REW)

$$G_{V1} = G_{VIA} + 20\log\left(1 + \frac{90k}{REX1}\right) + ATT \quad [\text{dB}]$$

$$f_1 = \frac{1}{2\pi \cdot CEX1 \cdot REX1} \quad [\text{Hz}], \quad f_2 = 25k \quad [\text{Hz}]$$

2. Repeat mode

$$G_{V2} = G_{VIA} + 20\log\left(1 + \frac{90k}{Z}\right) + ATT \quad [\text{dB}],$$

$$Z = \frac{REX1 \cdot REX2}{REX1 + REX2}$$

$$f_3 = \frac{1}{2\pi \cdot CEX2 \cdot REX2} \quad [\text{Hz}], \quad f_4 = 25k \quad [\text{Hz}]$$

G_{VIA}: Input Amp. G_V = 20dB

The sensitivity of music sensor (S) is computed by the formula mentioned below.

$$S = -\left(G_V^{*1} - 20\log\frac{130^{*2}}{30^{*3}}\right) = 12.7 - G_V \quad [\text{dB}]$$

- Note:
1. Search mode: G_{V1}, Repeat mode: G_{V2}
 2. Standard level of DIN pin (Dolby level)
 3. Standard sensing level of music sensor

Item	REX1, 2	CEX1, 2	G _{V1,2}	f _{1,3}	f _{2,4}	S (one-side channel)
Search mode	24kΩ	0.01μF	33.5dB	663Hz	25kHz	-14.8dB
Repeat mode	2.7kΩ	1μF	51.6dB	58.9Hz	25kHz	-33.0dB

Note: S is 6dB down in case of one-side channel. And this MS presented hysteresis lest MSOUT terminal should turn over again Hi level or Lo level, in case of thresh S level constantly.

Music Sensor Time Constant

(1) Sensing no signal to signal (Attack) is determined by C6.

0.01μF to 1μF capacitor C6 can be applicable.

Sensing no signal to signal = $C6 \times 45000$ (sec)

(2) Sensing signal to no signal (Recovery) is determined by C6 and R11, however preceding (1), 100kΩ to 1MΩ R11 can be applicable.

Sensing signal to no signal = $C6 \times R11$ (sec)

Music Sensor Output (MSOUT)

As for the internal circuit of music sensor block, music sensor output pin is connected to the collector of NPN type directly, therefore, output level will be “high” when sensing no signal. And output level will be “low” when sensing signal.

Connection with microcomputer, design I_L at 1mA Typ.

$$I_L = \frac{DV_{CC} - MSOUT_{Lo}^*}{R_L}$$

*MSOUT_{Lo}: Sensing signal (about 1V)

Note: Supply voltage of MSOUT pin must be less than V_{CC} voltage.

The Tolerances of External Components for Dolby NR-Block (Only HA12192F Series)

For adequate Dolby NR tracking response, take external components shown below.

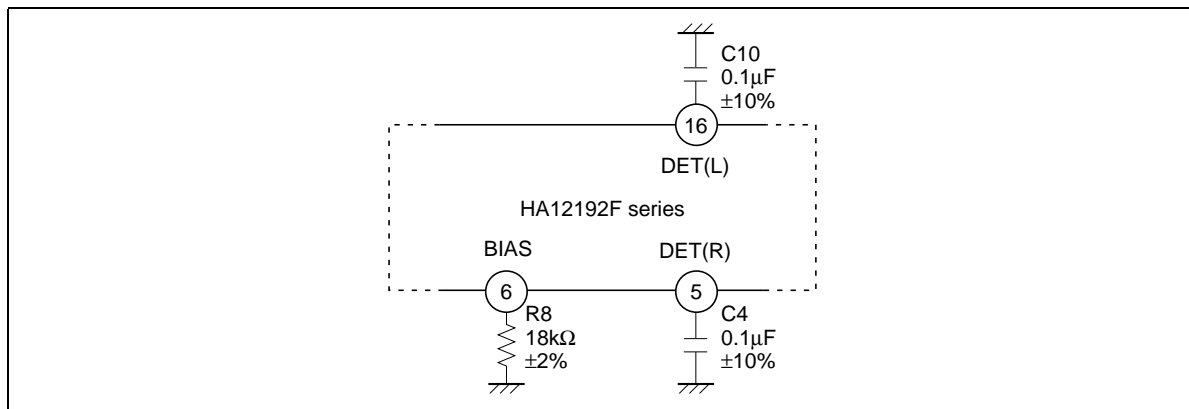

Figure 6 Tolerance of External Components

HA12192F/HA12197F/HA12212F Series

Absolute Maximum Rating (Ta=25°C)

Item	Symbol	Rating	Unit	Note
Supply voltage	V _{cc} Max	16	V	
Power dissipation	Pd	400	mW	Ta ≤ 85°C
Operating temperature	Topr	-40 to +85	°C	
Storage temperature	Tstg	-55 to +125	°C	

HA12192F/HA12197F/HA12212F Series

Electrical Characteristics HA12192F/HA12212F Series

(Ta = 25°C, PBOUT Level, 300mVrms(HA12192F/HA12212F), 387.5mVrms (HA12193F), 450mVrms(HA12194F), V_{CC} = 9.0V)

Item	Symbol	Min	Typ	Max	Unit	Test Condition	Remark
Quiescent current	I _Q	—	9.5	—	mA	NR-ON, 70μ, No signal	
Input Amp. gain (HA12192F/HA12212F)	G _V IA	19.0	20.0	21.0	dB	V _{in} = 0dB, f = 1kHz	
Input Amp. gain (HA12193F)	G _V IA	21.2	22.2	23.2			
Input Amp. gain (HA12194F)	G _V IA	22.5	23.5	24.5			
B-type Decode boost	DEC-2k (1)	2.8	4.3	5.8	dB	V _{out} = -20dB, f = 2kHz	
	DEC-2k (2)	7.0	8.5	10.0		V _{out} = -30dB, f = 2kHz	
	DEC-5k (1)	1.7	3.2	4.7		V _{out} = -20dB, f = 5kHz	
	DEC-5k (2)	6.7	8.2	9.7		V _{out} = -30dB, f = 5kHz	
Signal handling	Vo max	12.0	13.0	—	dB	THD = 1%, f = 1kHz	*1
Signal to noise ratio	S / N	70.0	80.0	—	dB	Rg = 5.1kΩ, CCIR / ARM	
THD	THD	—	0.05	0.3	%	V _{in} = 0dB, f = 1kHz	
Channel separation	CT RL (1)	65	80.0	—	dB	V _{in} = 10dB, f = 1kHz	DIN IN
	CT RL (2)	50	60.0	—			EQ IN
PB-EQ gain	G _V EQ 1k	37.0	40.0	43.0	dB	V _{in} = 0.6mVrms, f = 1kHz	120μ
	G _V EQ 10k(1)	33.0	36.0	39.0		V _{in} = 0.6mVrms, f = 10kHz	
	G _V EQ 10k(2)	29.0	32.0	35.0			70μ
PB-EQ maximum output	VoM	300	600	—	mVrms	THD = 1%, f = 1kHz	*1
PB-EQ THD	THD-EQ	—	0.05	0.3	%	V _{in} = 0.6mVrms, f = 1kHz	
Noise voltage level converted in input	V _N	—	0.7	1.5	μVrms	Rg = 680Ω, DIN-AUDIO	
MS sensing level	V _{ON}	-18.0	-14.0	-10.0	dB	f = 5kHz	
MS output low level	V _{OL}	—	1.0	1.5	V		
MS output leak current	I _{OH}	—	0.0	2.0	μA		
Control voltage	V _{IL}	-0.2	—	1.0	V		
	V _{IH}	3.5	—	5.3			

Note: 1. V_{CC} = 6.5V (HA12192F/HA12212F)

V_{CC} = 6.8V (HA12193F)

V_{CC} = 7.2V (HA12194F)

HA12192F/HA12197F/HA12212F Series

Electrical Characteristics HA12197F Series

($T_a = 25^\circ\text{C}$, PBOUT Level, 300mVrms(HA12197F), 387.5mVrms(HA12198F), 450mVrms(HA12199F), $V_{CC} = 9.0\text{V}$)

Item	Symbol	Min	Typ	Max	Unit	Test Condition	Remark
Quiescent current	I_Q	—	4.7	7.1	mA	70 μ , No signal	
Input Amp. gain (HA12197F)	G_V IA	19.0	20.0	21.0	dB	$V_{in} = 0\text{dB}$, $f = 1\text{kHz}$	
Input Amp. gain (HA12198F)	G_V IA	21.2	22.2	23.2			
Input Amp. gain (HA12199F)	G_V IA	22.5	23.5	24.5			
Signal handling	V_o max	12.0	13.0	—	dB	THD = 1%, $f = 1\text{kHz}$	*1
Signal to noise ratio	S / N	70.0	80.0	—	dB	$R_g = 5.1\text{k}\Omega$, CCIR / ARM	
THD	THD	—	0.05	0.3	%	$V_{in} = 0\text{dB}$, $f = 1\text{kHz}$	
Channel separation	CT RL (1)	65	80.0	—	dB	$V_{in} = 10\text{dB}$, $f = 1\text{kHz}$	DIN IN
	CT RL (2)	50	60.0	—			EQ IN
PB-EQ gain	G_V EQ 1k	37.0	40.0	43.0	dB	$V_{in} = 0.6\text{mVrms}$, $f = 1\text{kHz}$	120 μ
	G_V EQ 10k(1)	33.0	36.0	39.0		$V_{in} = 0.6\text{mVrms}$, $f = 10\text{kHz}$	
	G_V EQ 10k(2)	29.0	32.0	35.0			70 μ
PB-EQ maximum output	V_oM	300	600	—	mVrms	THD = 1%, $f = 1\text{kHz}$	*1
PB-EQ THD	THD-EQ	—	0.05	0.3	%	$V_{in} = 0.6\text{mVrms}$, $f = 1\text{kHz}$	
Noise voltage level converted in input	V_N	—	0.7	1.5	μVrms	$R_g = 680\Omega$, DIN-AUDIO	
MS sensing level	V_{ON}	-18.0	-14.0	-10.0	dB	$f = 5\text{kHz}$	
MS output low level	V_{OL}	—	1.0	1.5	V		
MS output leak current	I_{OH}	—	0.0	2.0	μA		
Control voltage	V_{IL}	-0.2	—	1.0	V		
	V_{IH}	3.5	—	5.3			

Note: 1. $V_{CC} = 6.5\text{V}$ (HA12197F)

$V_{CC} = 6.8\text{V}$ (HA12198F)

$V_{CC} = 7.2\text{V}$ (HA12199F)

HA12192F/HA12197F/HA12212F Series

Test Circuit

HA12192F/HA12197F Series

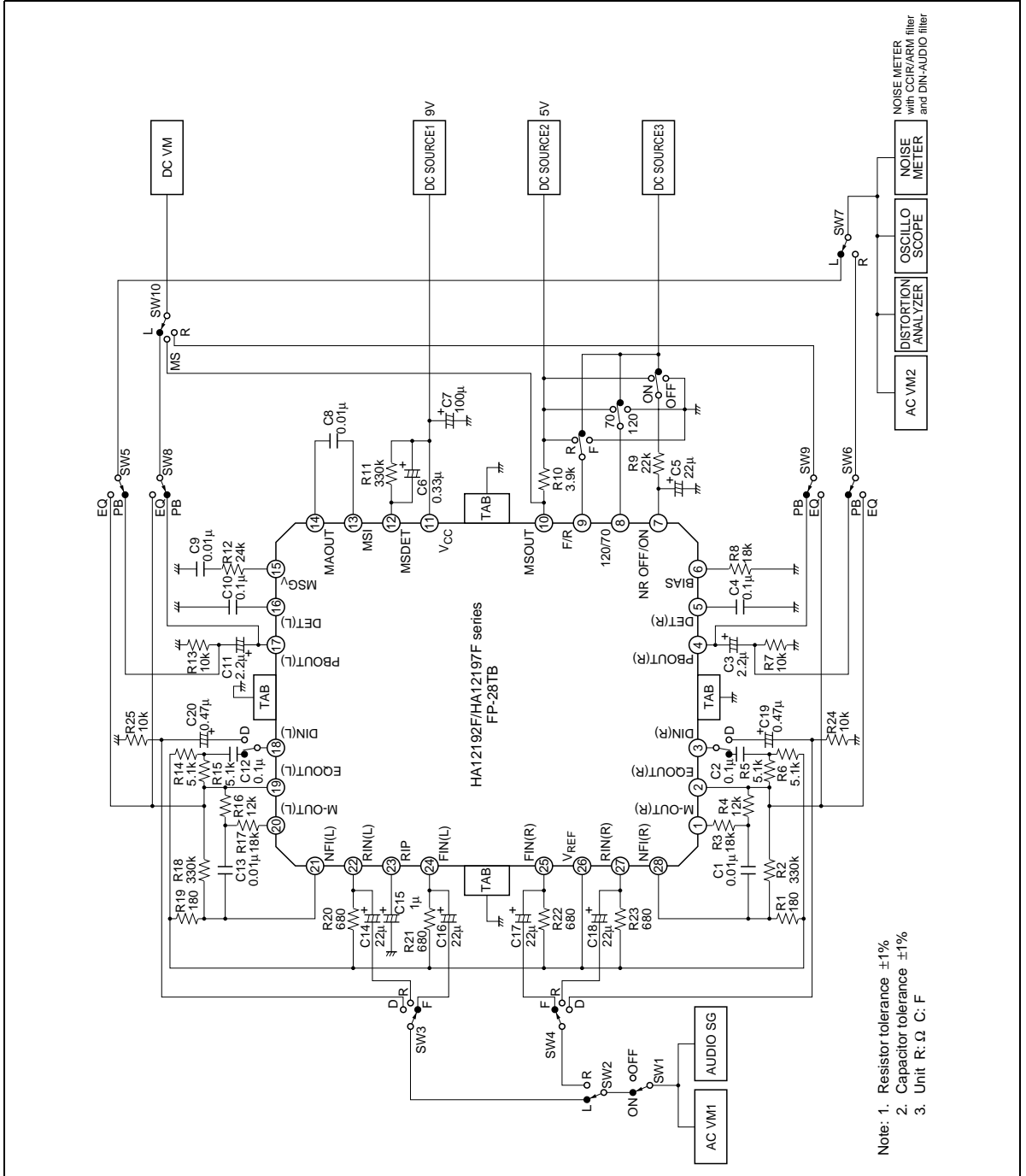

HA12192F/HA12197F/HA12212F Series

HA12212F

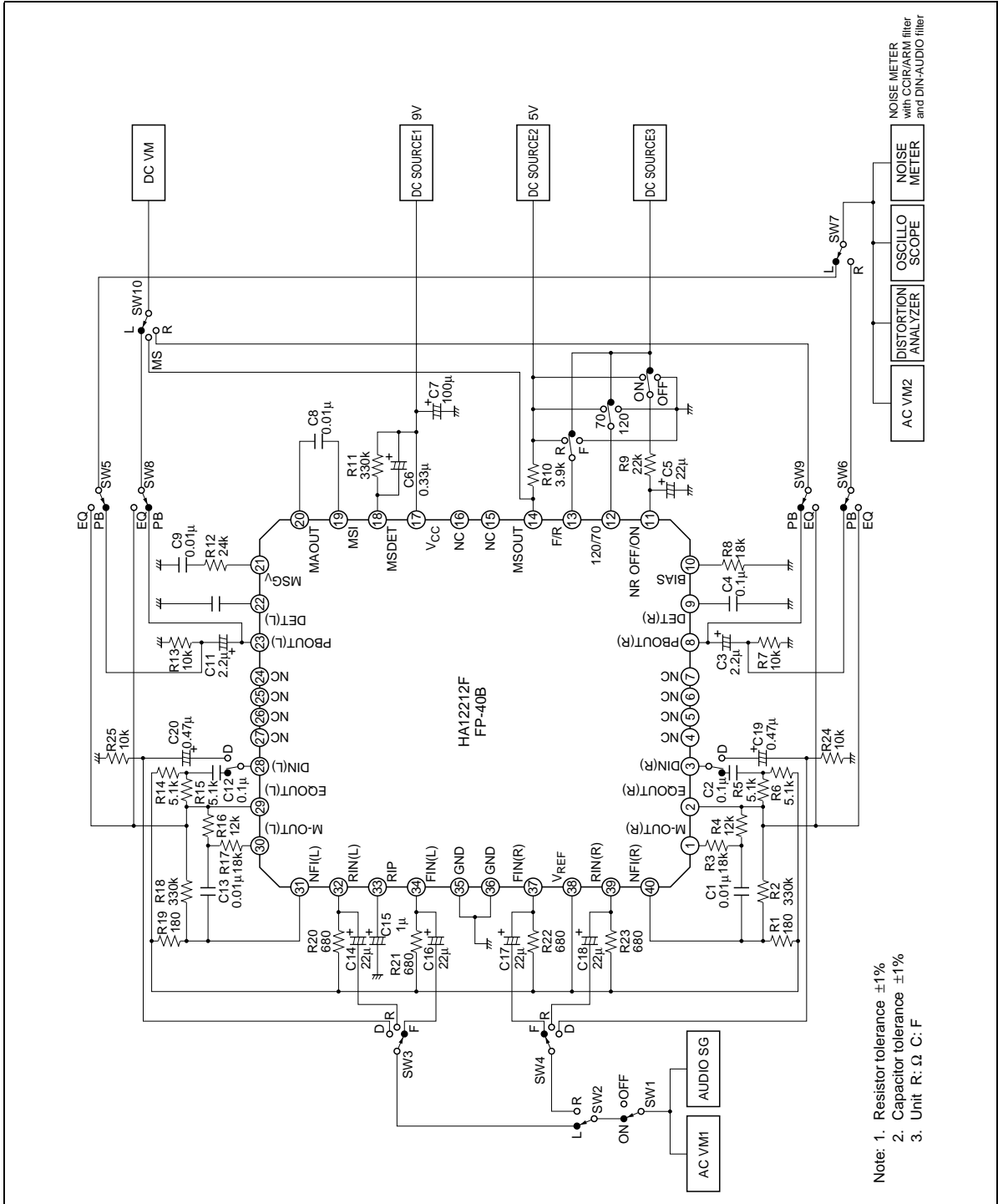

Characteristic Curves

HA12192F Series

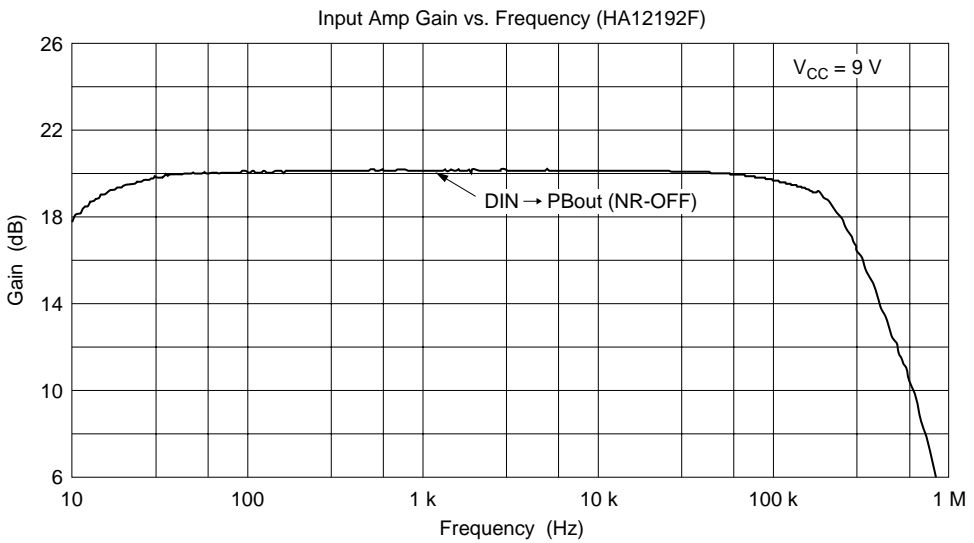
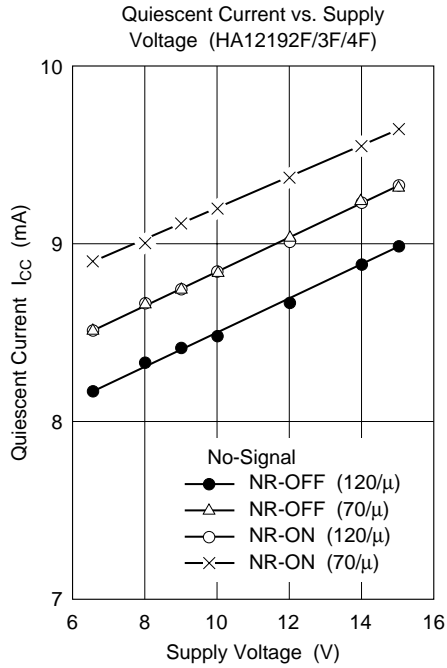

HA12192F/HA12197F/HA12212F Series

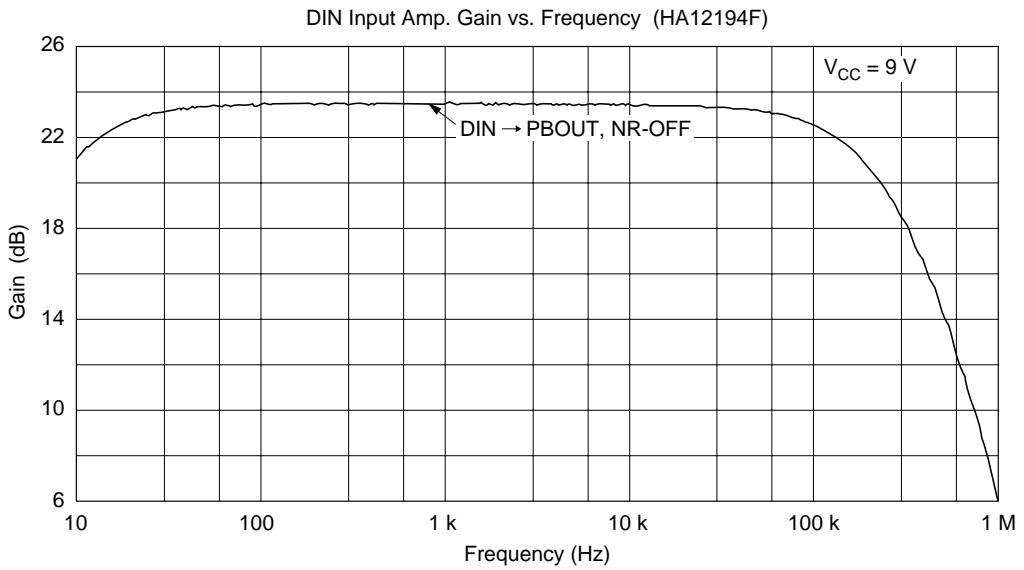
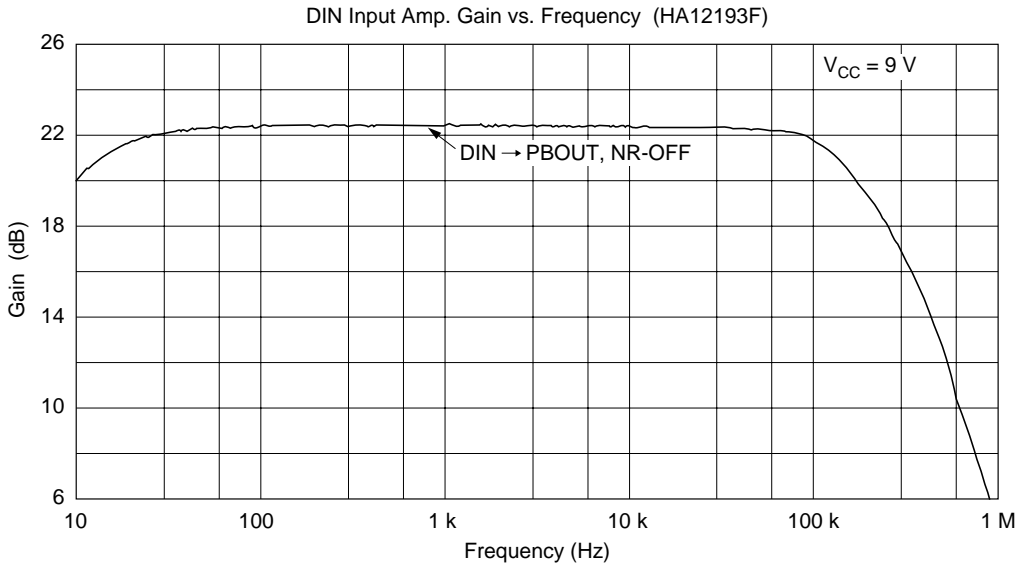

HA12192F/HA12197F/HA12212F Series

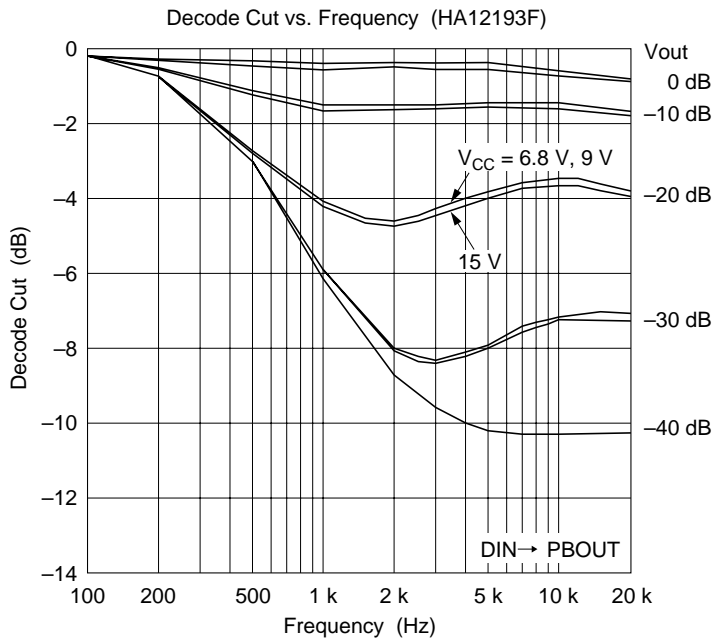
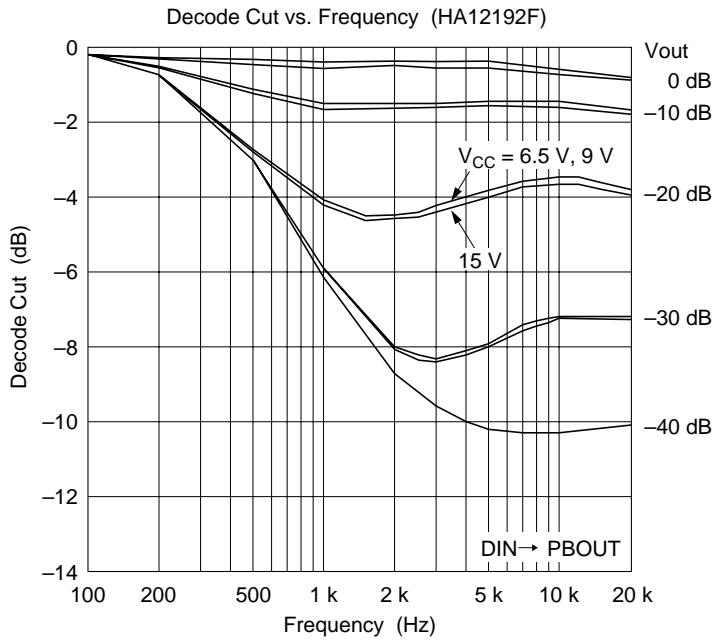

HA12192F/HA12197F/HA12212F Series

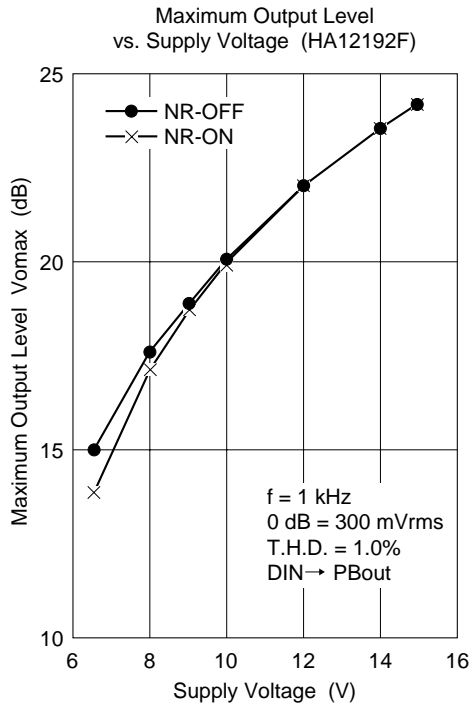
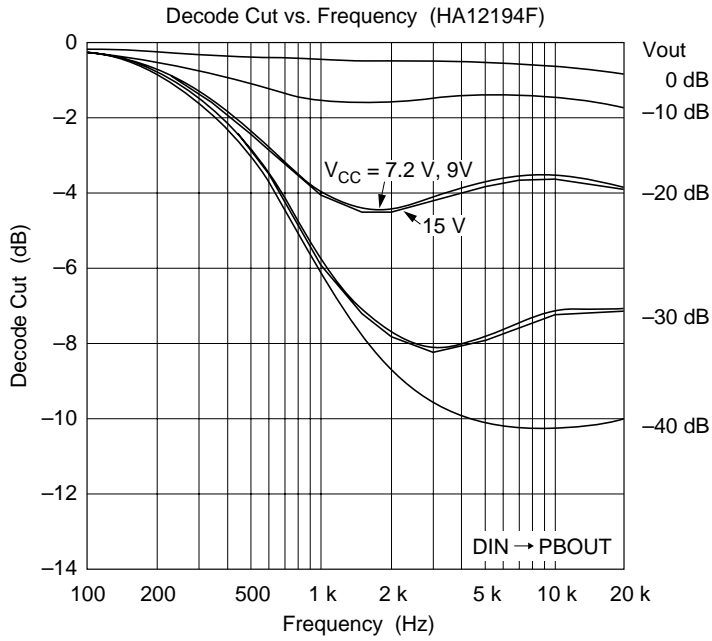

HA12192F/HA12197F/HA12212F Series

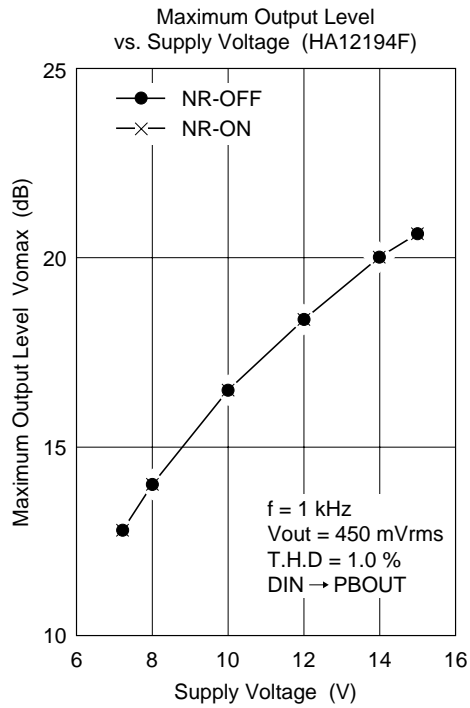
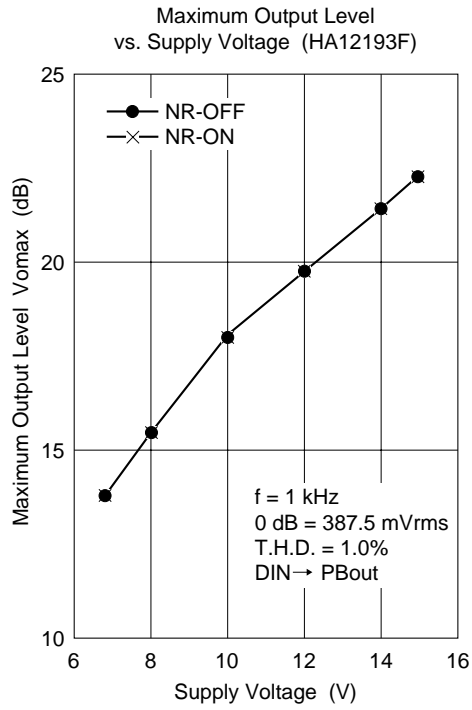

HA12192F/HA12197F/HA12212F Series

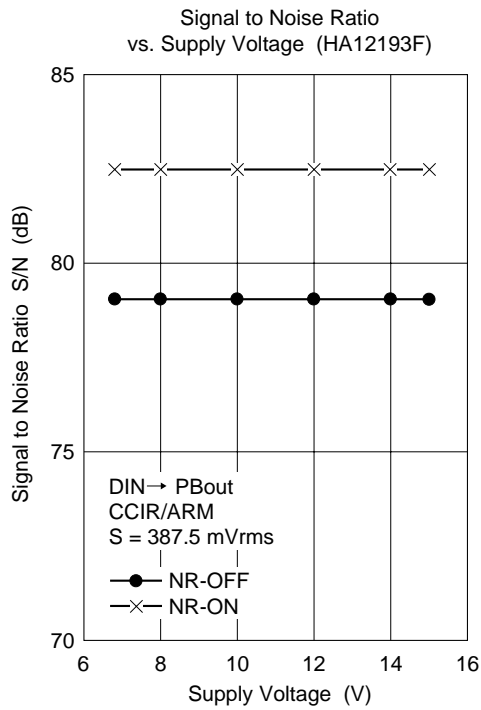
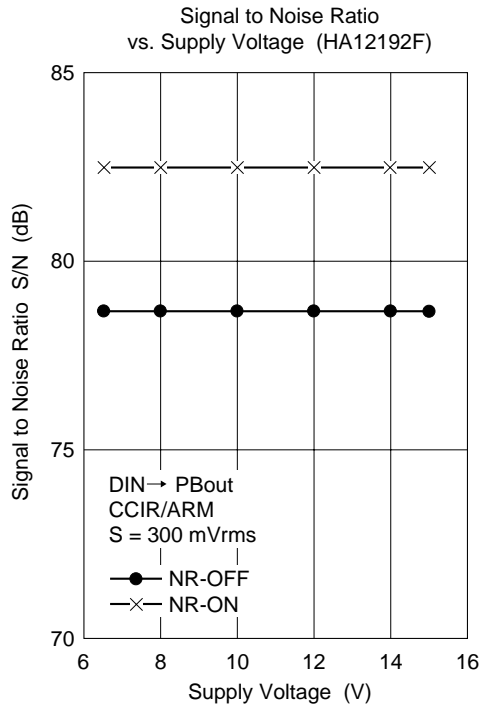

HA12192F/HA12197F/HA12212F Series

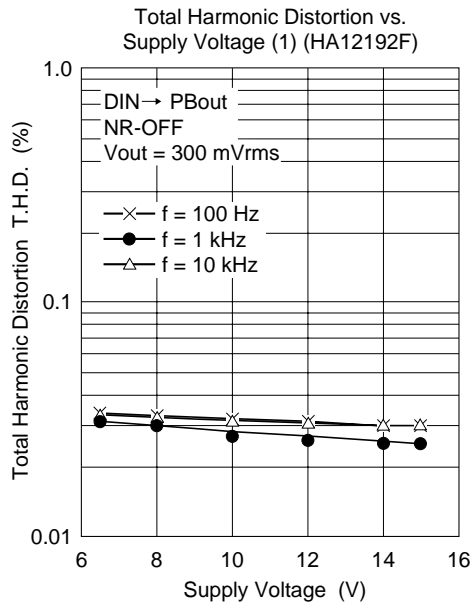
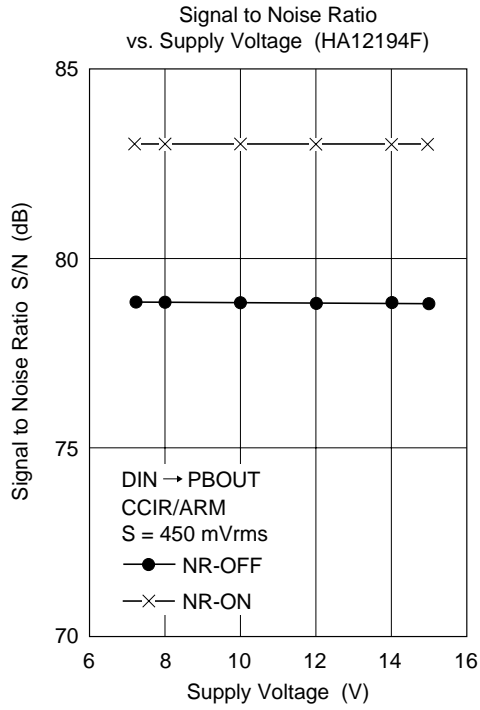

HA12192F/HA12197F/HA12212F Series

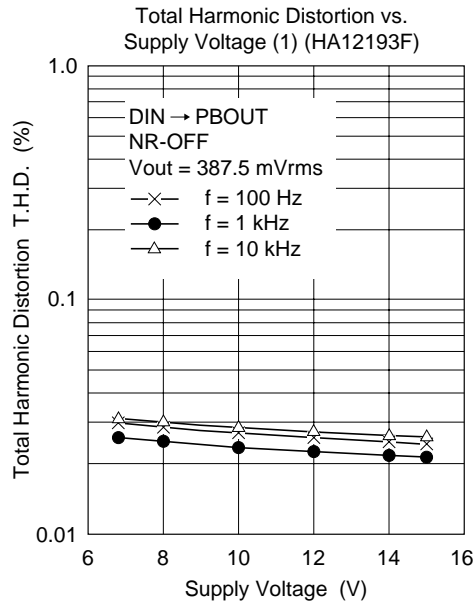
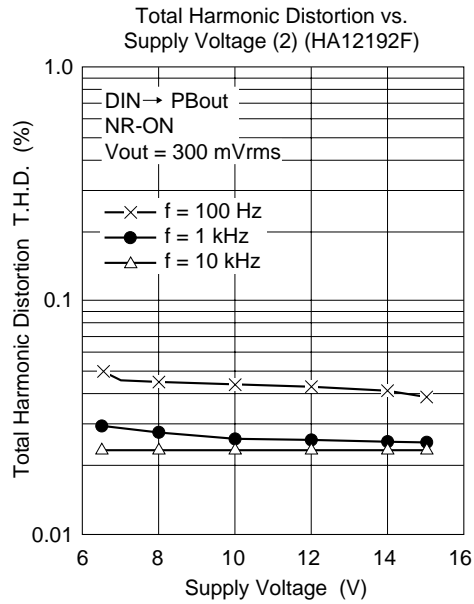

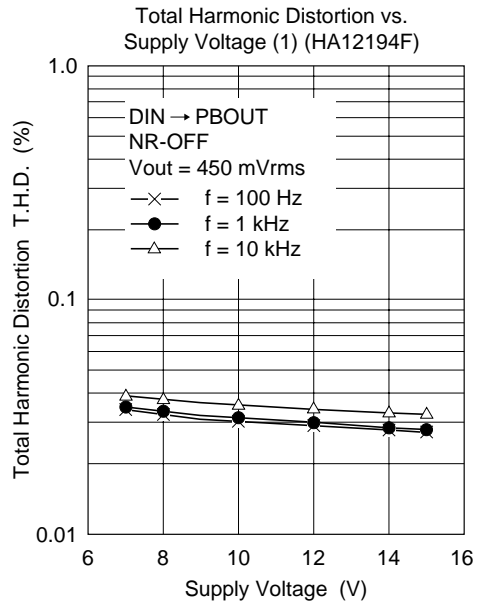
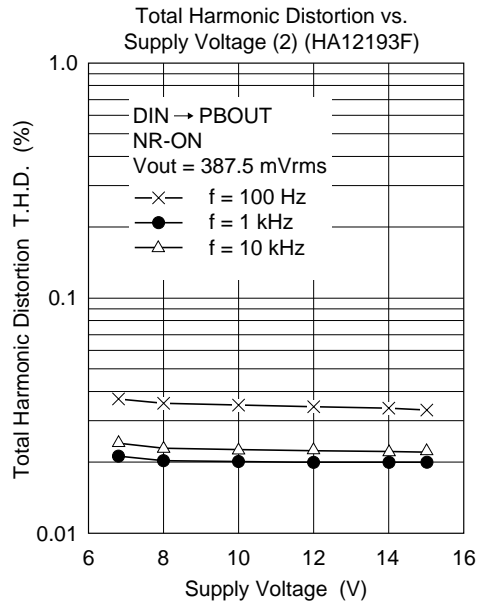

HA12192F/HA12197F/HA12212F Series

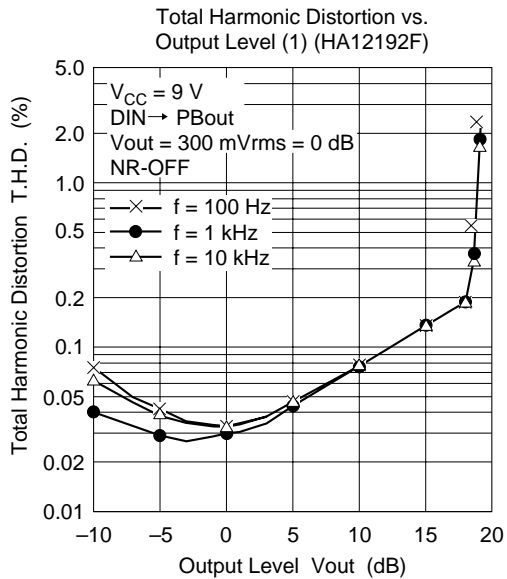
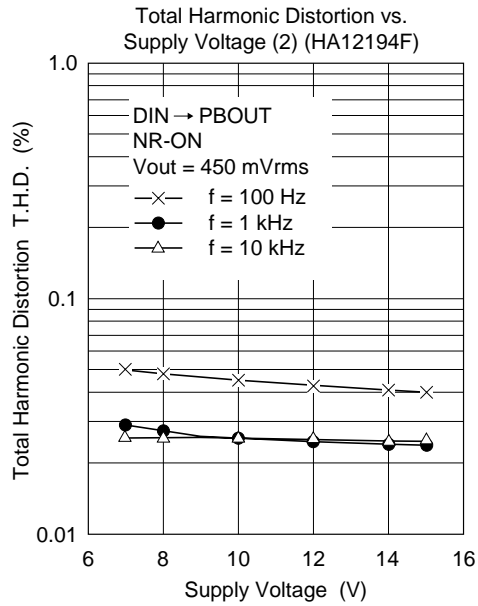

HA12192F/HA12197F/HA12212F Series

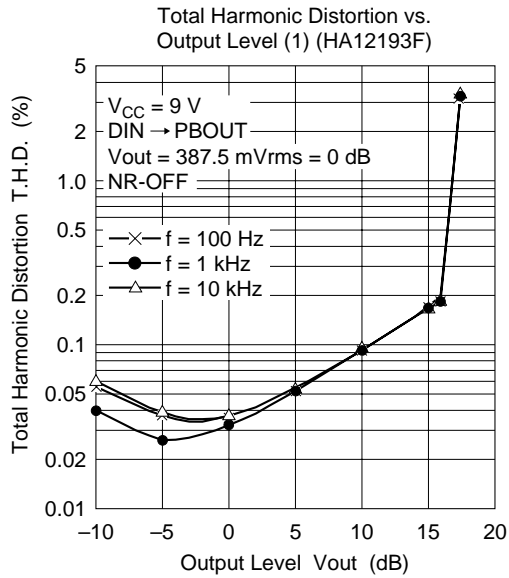
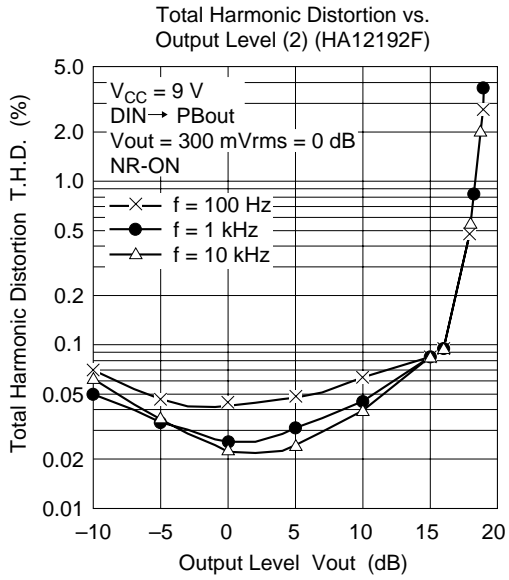

HA12192F/HA12197F/HA12212F Series

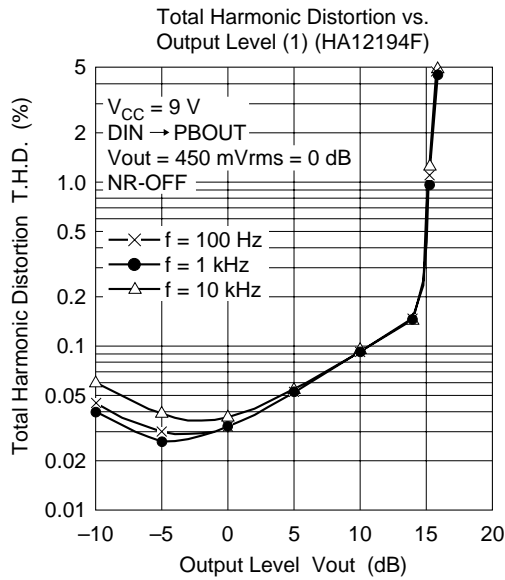
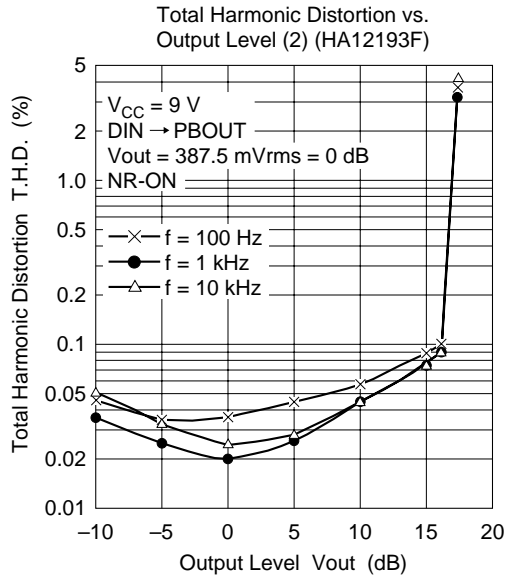

HA12192F/HA12197F/HA12212F Series

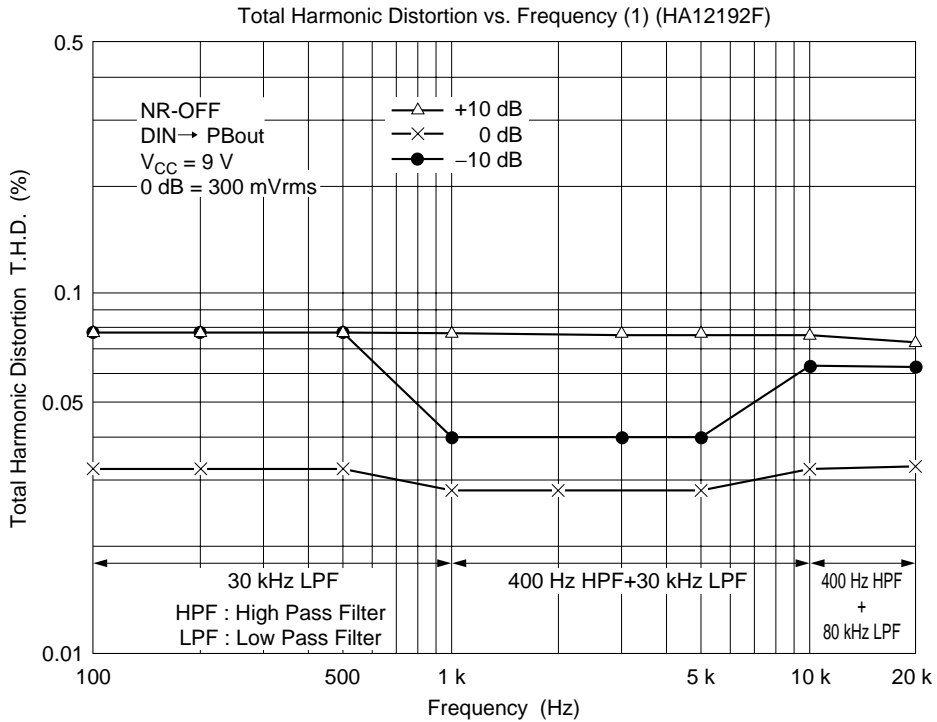
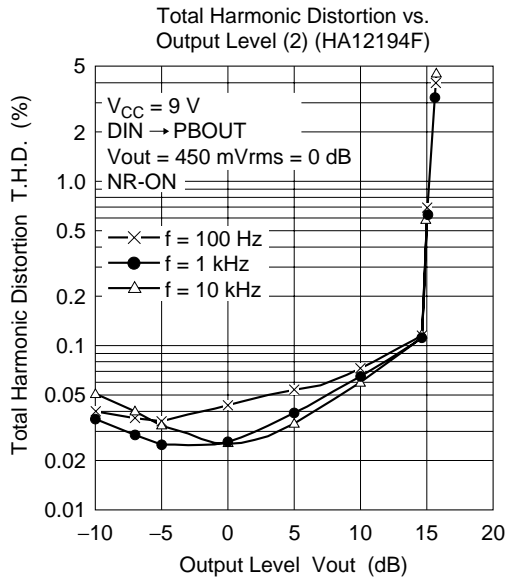

HA12192F/HA12197F/HA12212F Series

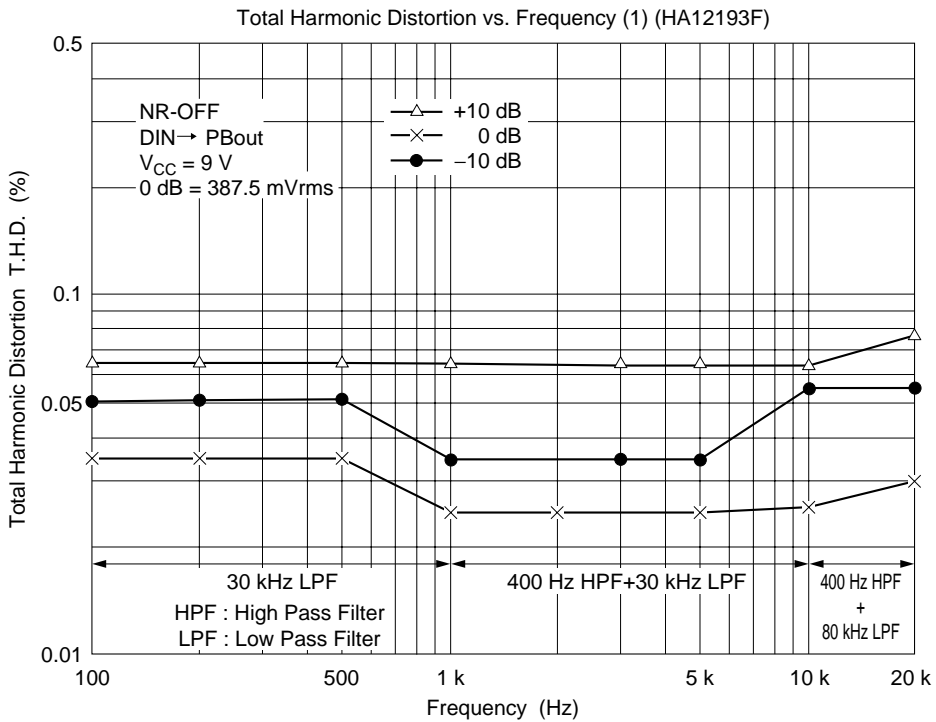
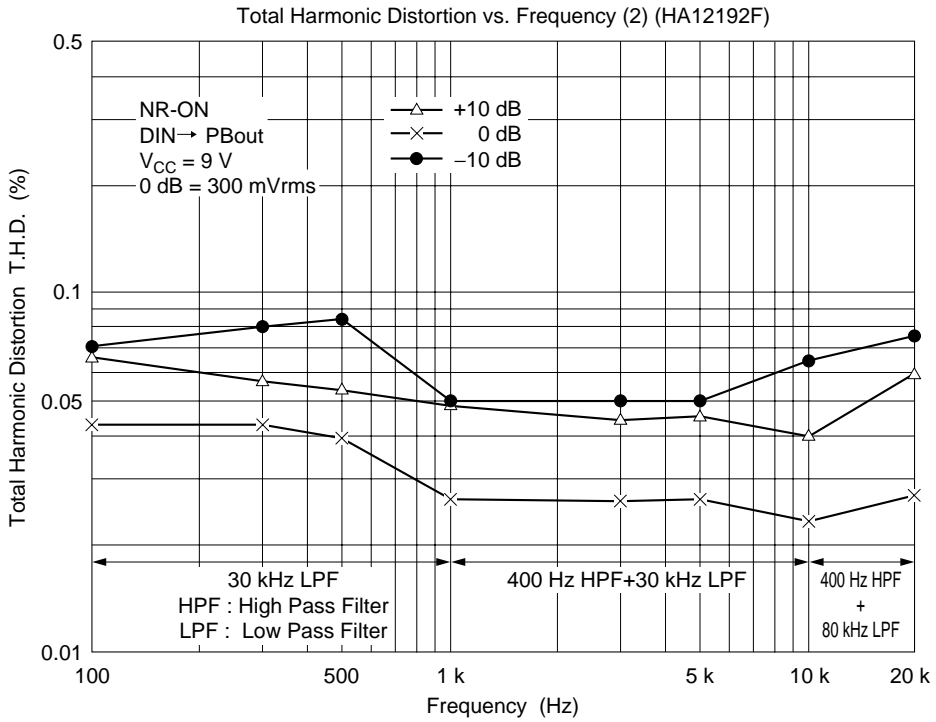

HA12192F/HA12197F/HA12212F Series

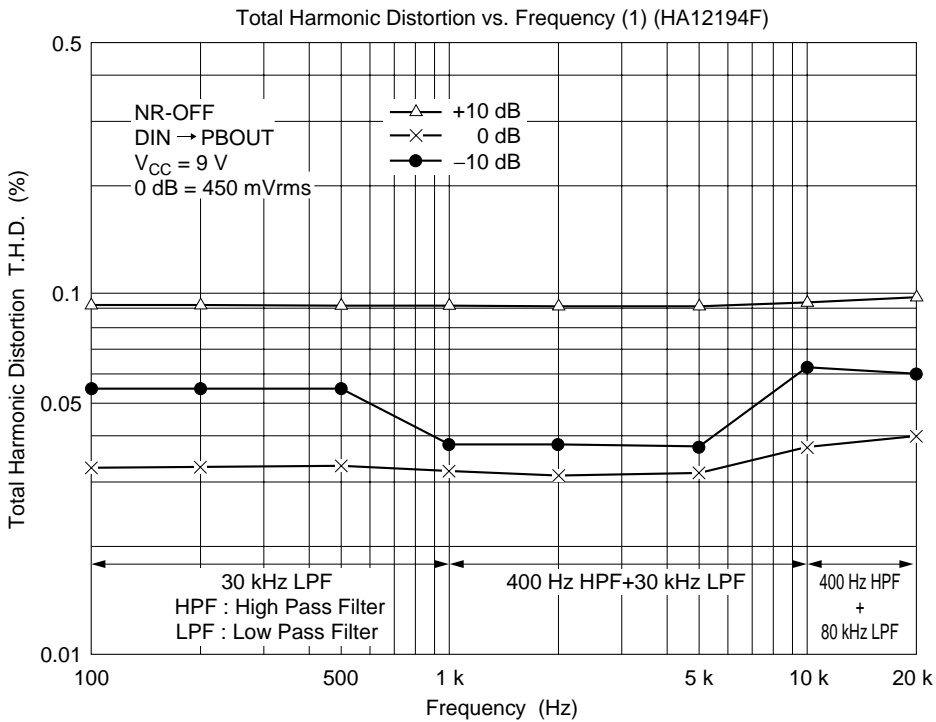
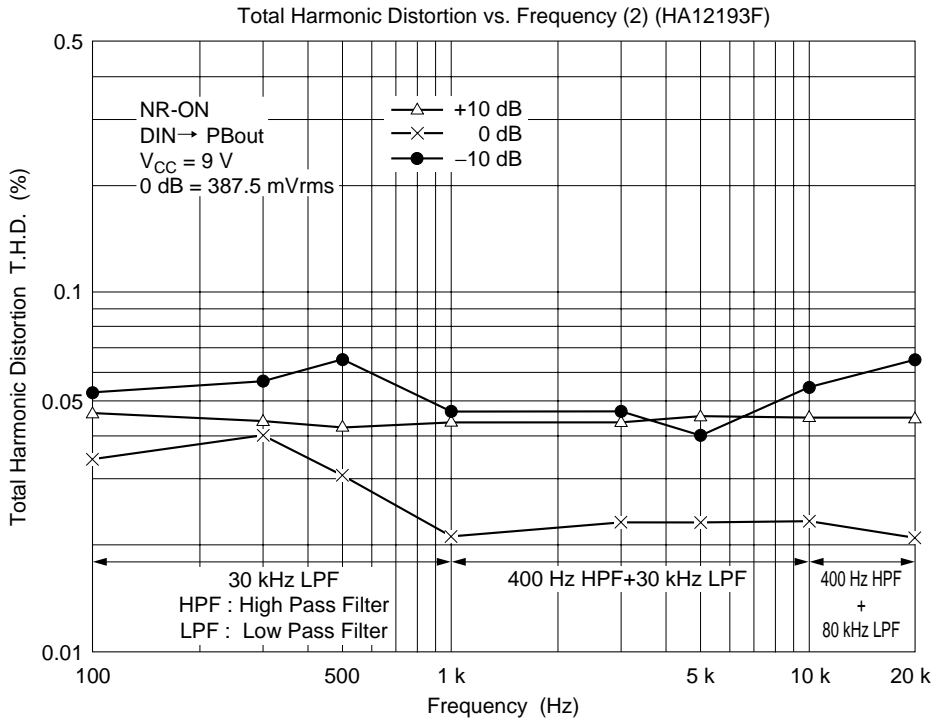

HA12192F/HA12197F/HA12212F Series

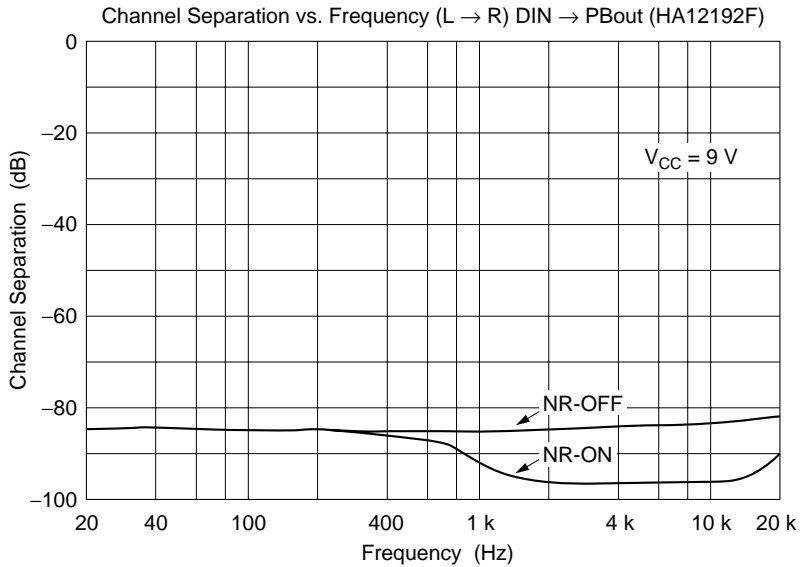
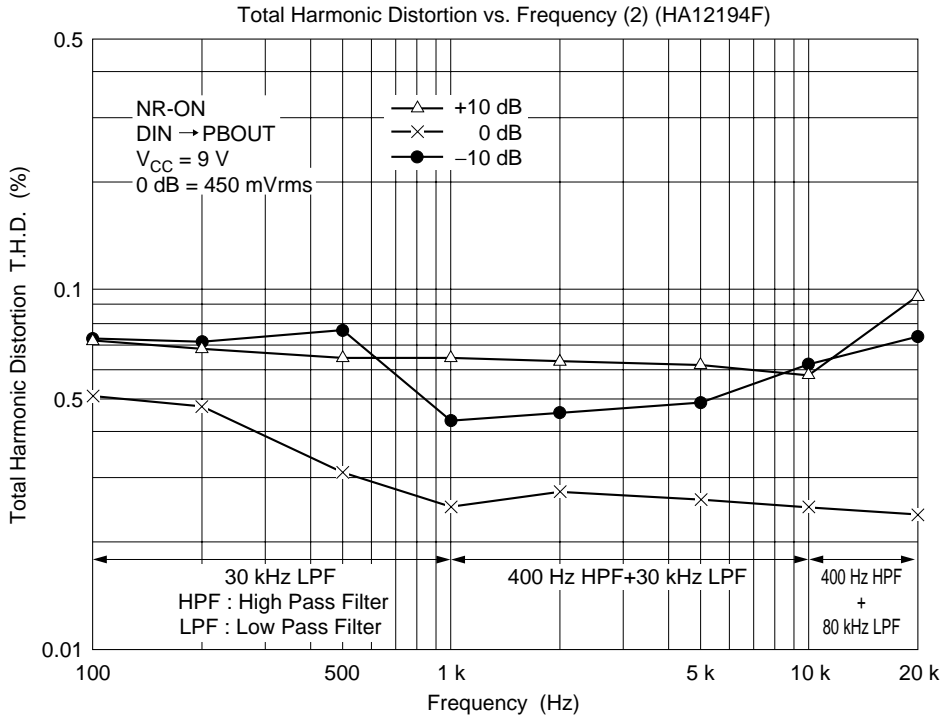

HA12192F/HA12197F/HA12212F Series

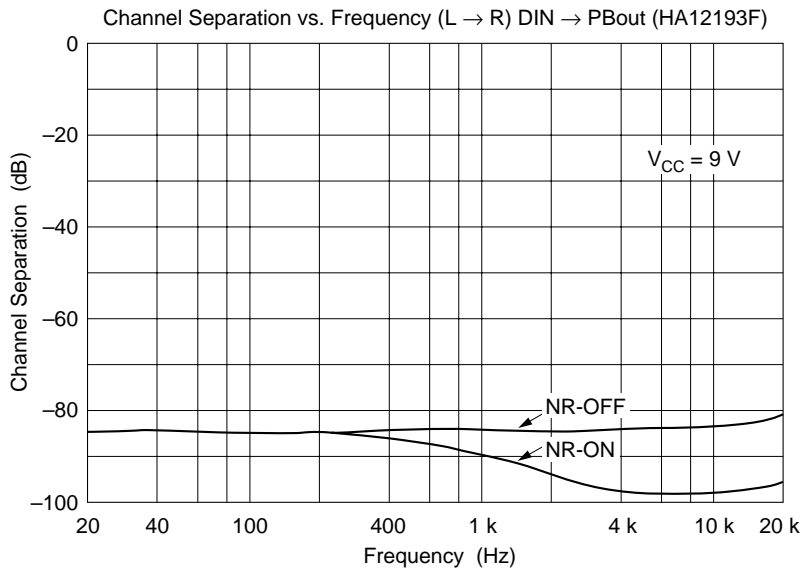
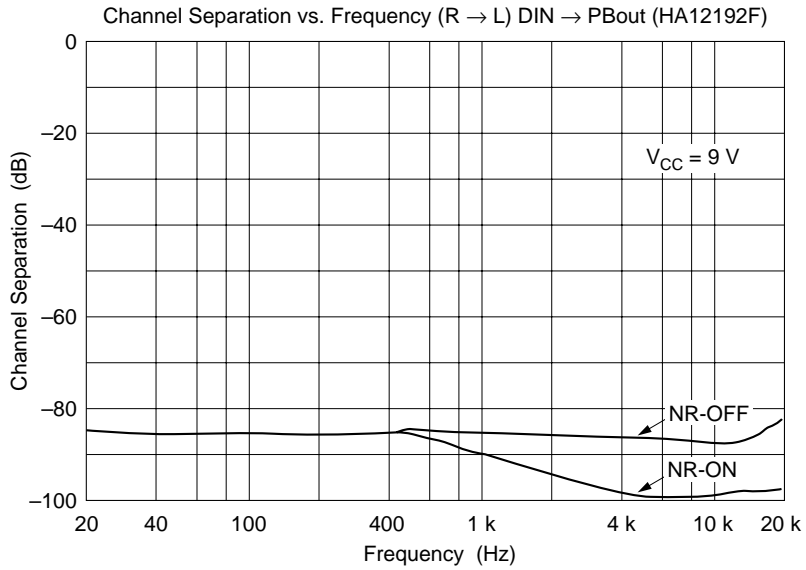

HA12192F/HA12197F/HA12212F Series

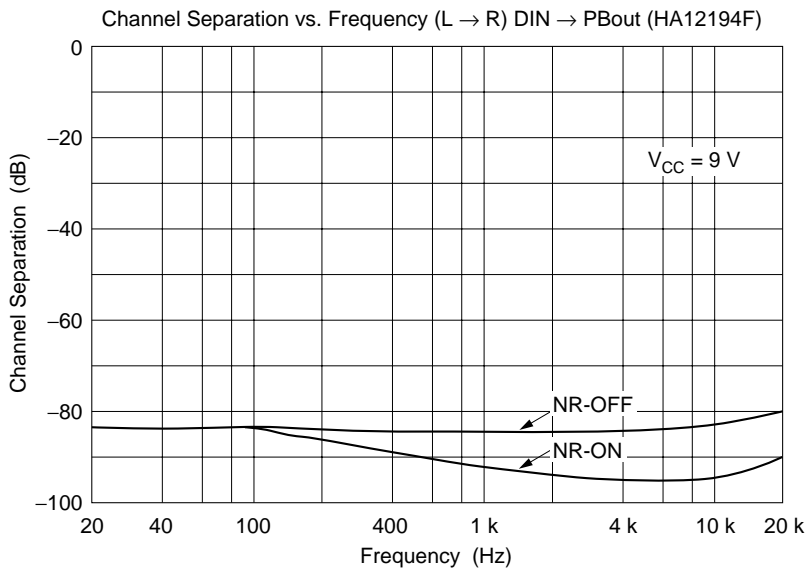
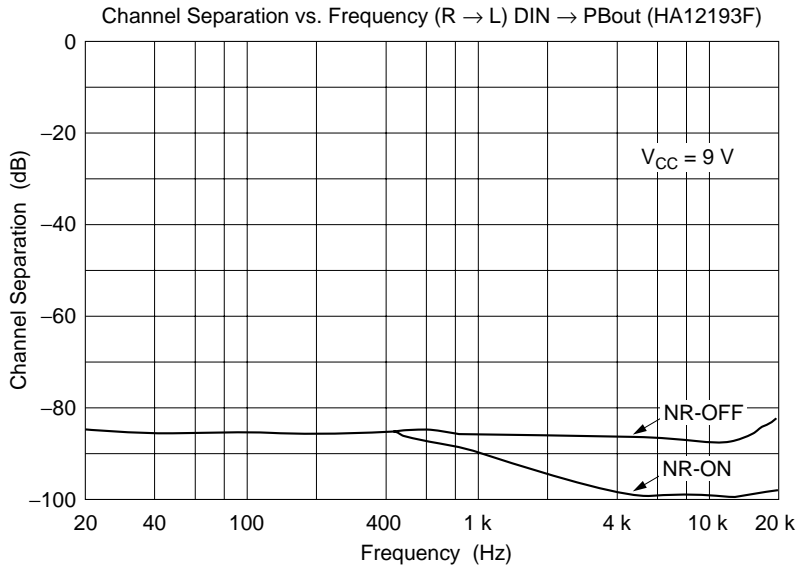

HA12192F/HA12197F/HA12212F Series

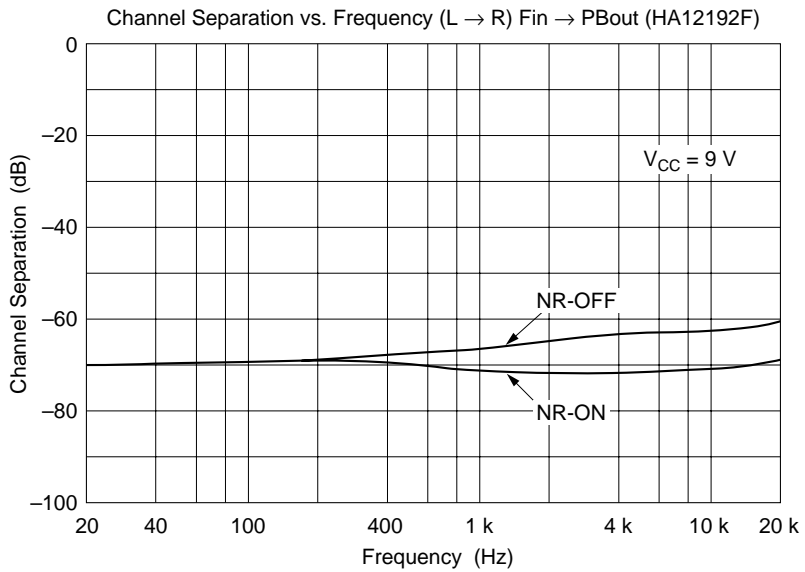
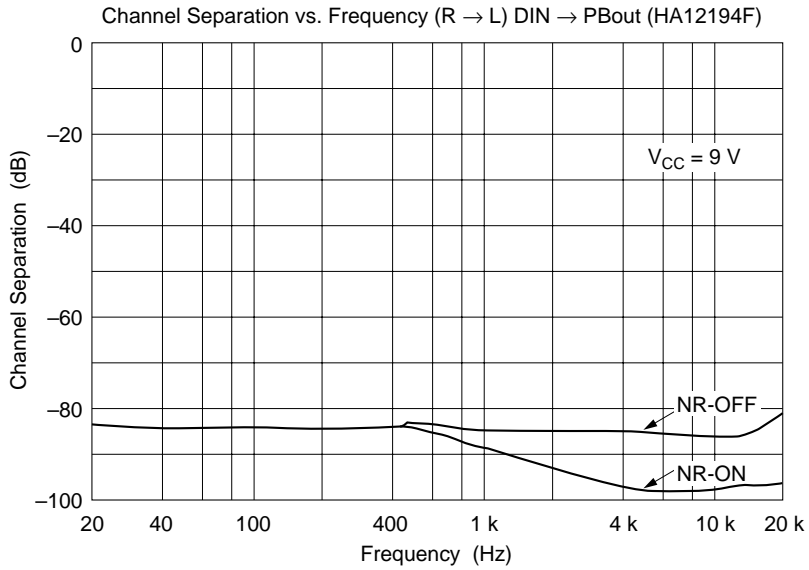

HA12192F/HA12197F/HA12212F Series

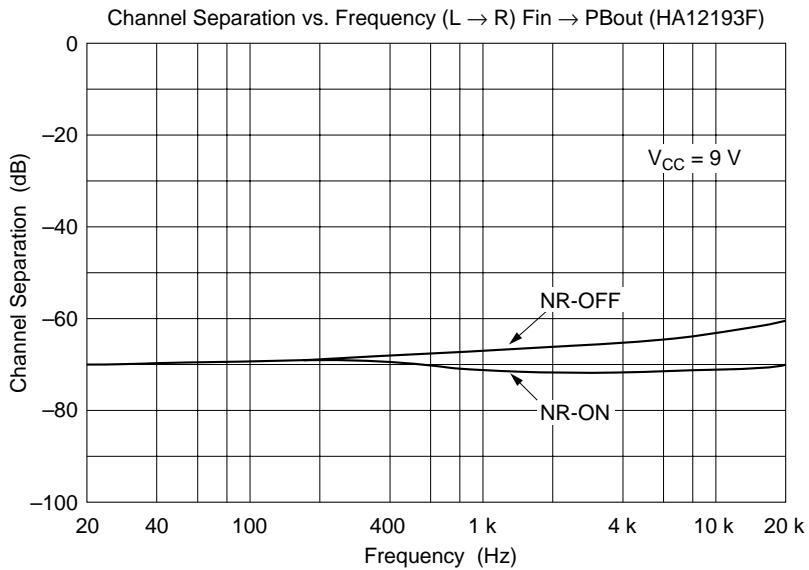
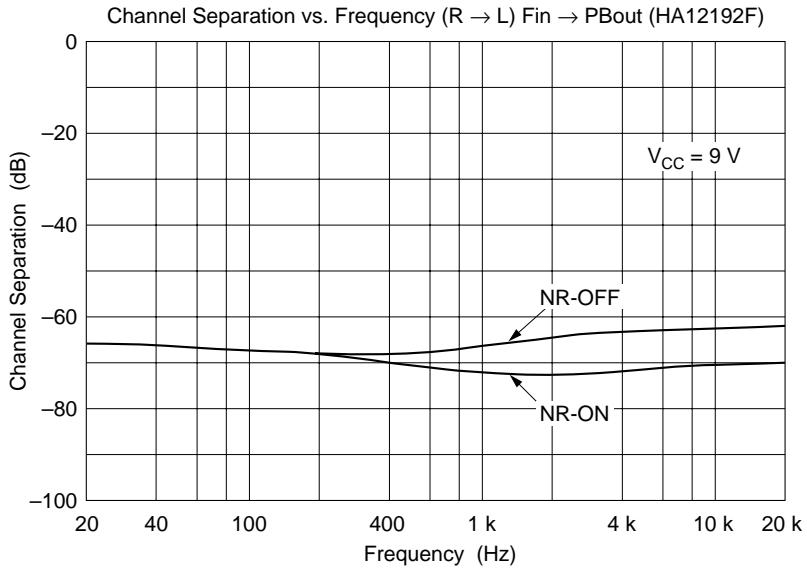

HA12192F/HA12197F/HA12212F Series

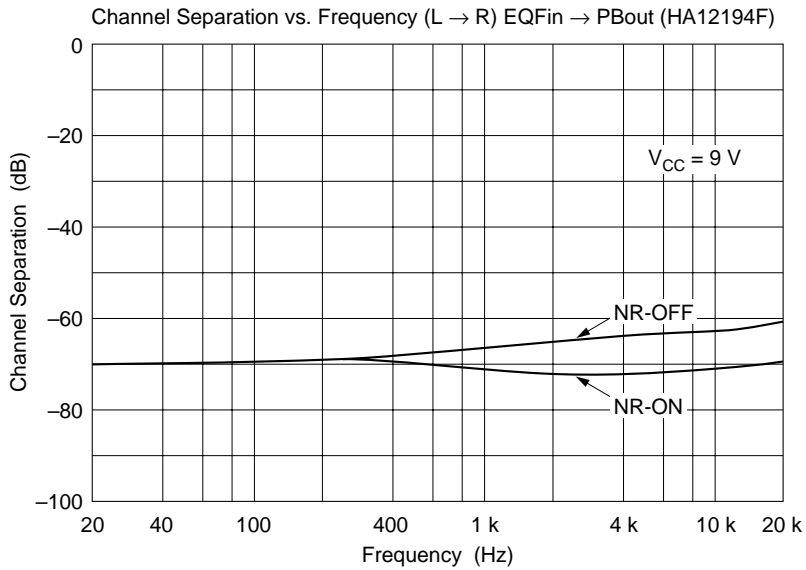
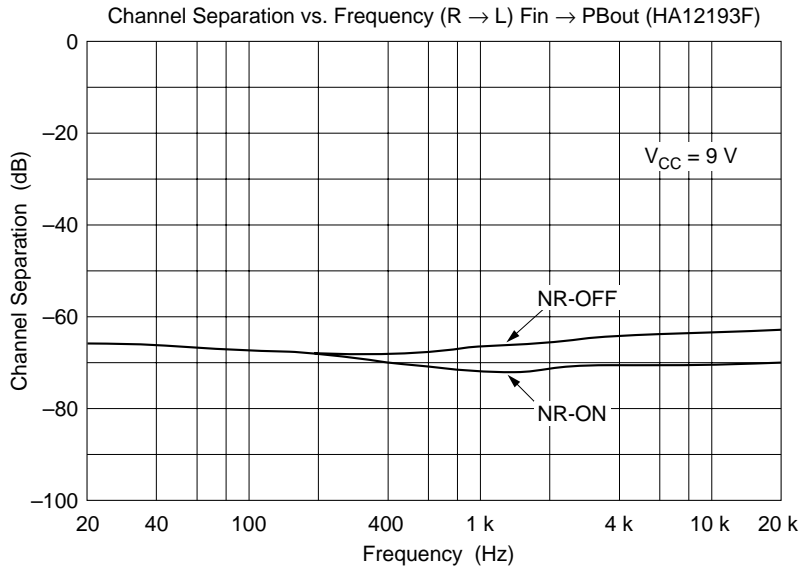

HA12192F/HA12197F/HA12212F Series

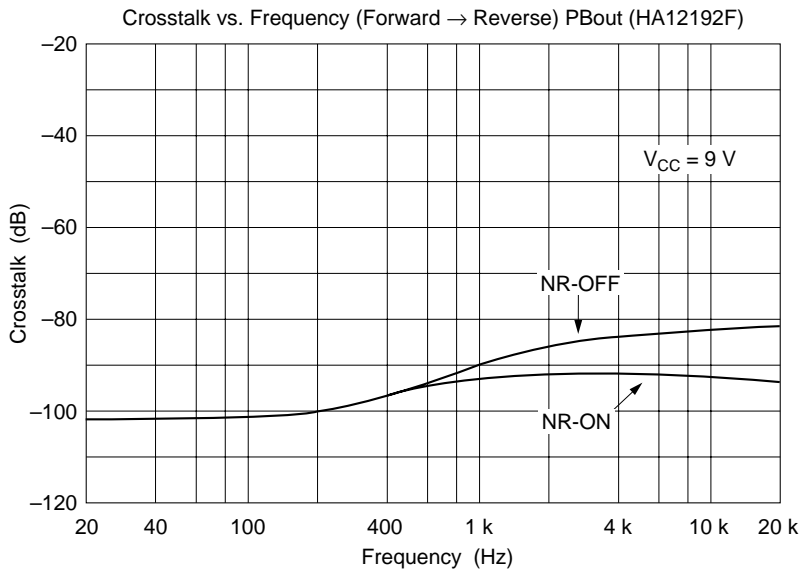
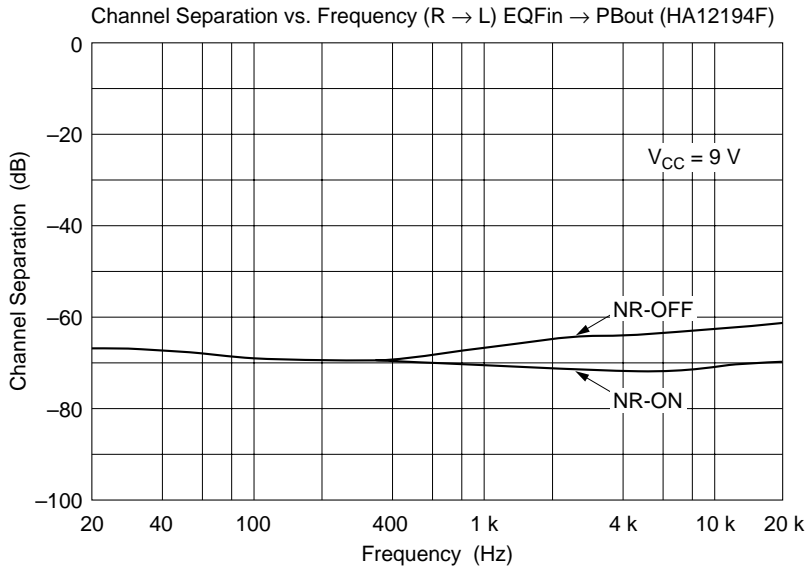

HA12192F/HA12197F/HA12212F Series

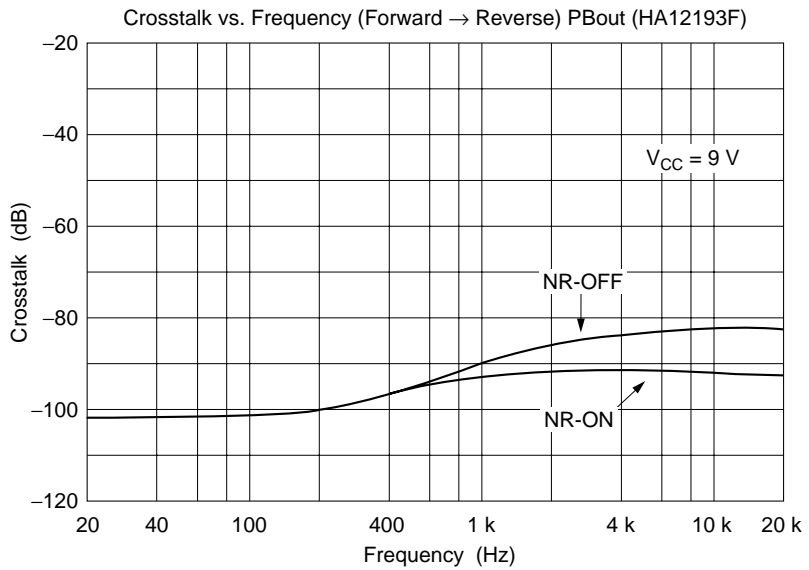
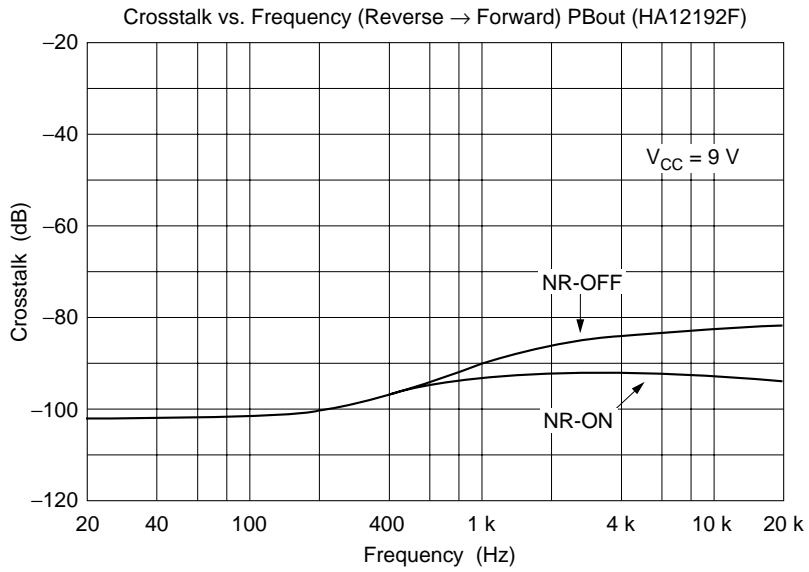

HA12192F/HA12197F/HA12212F Series

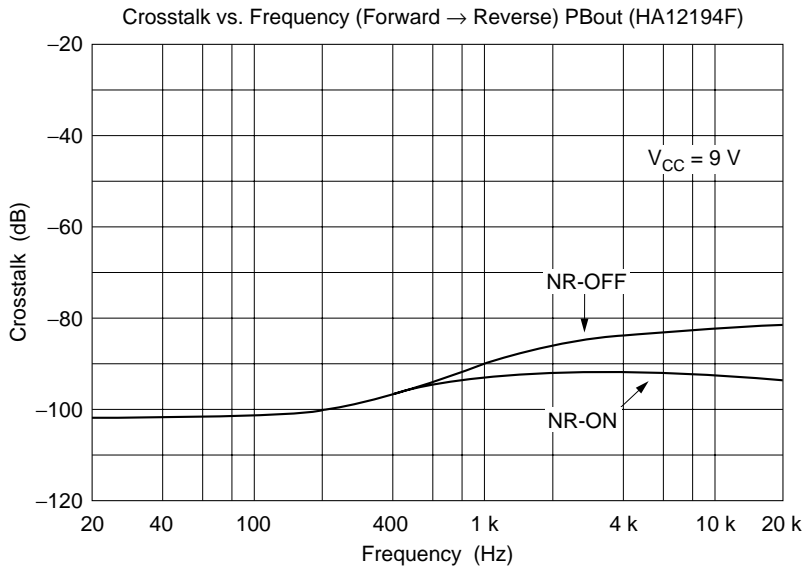
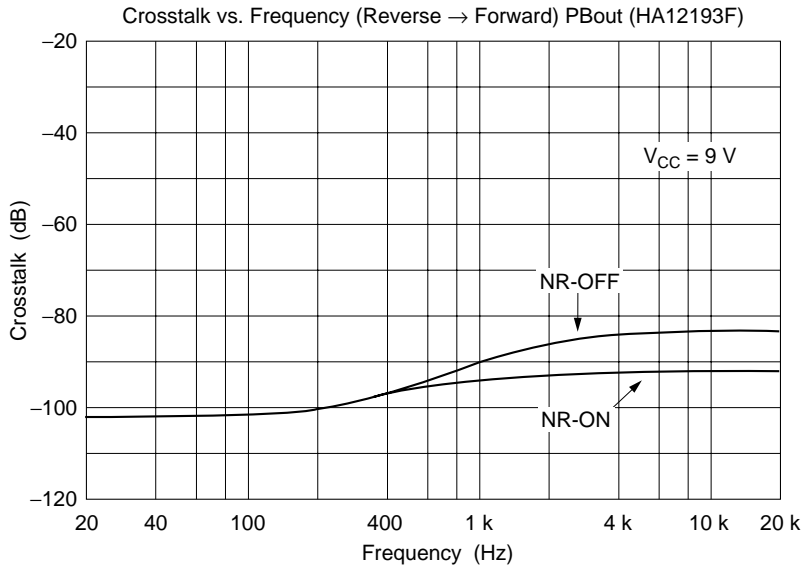

HA12192F/HA12197F/HA12212F Series

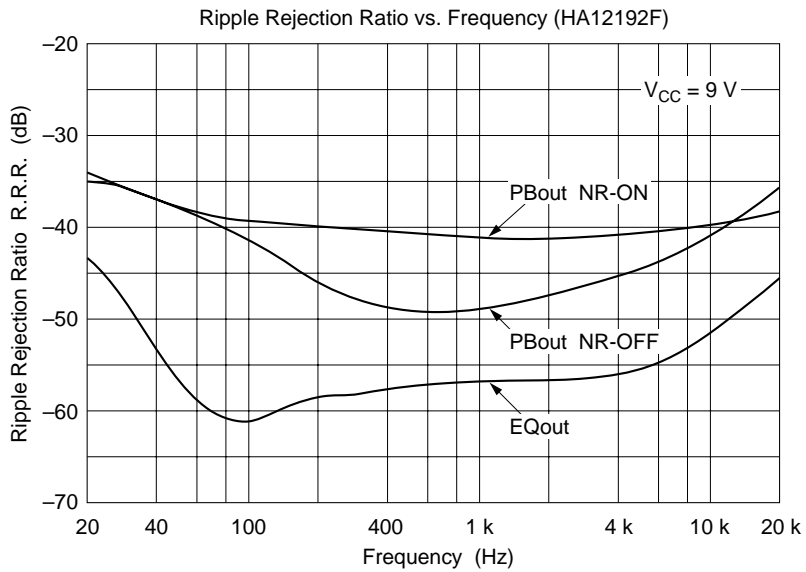
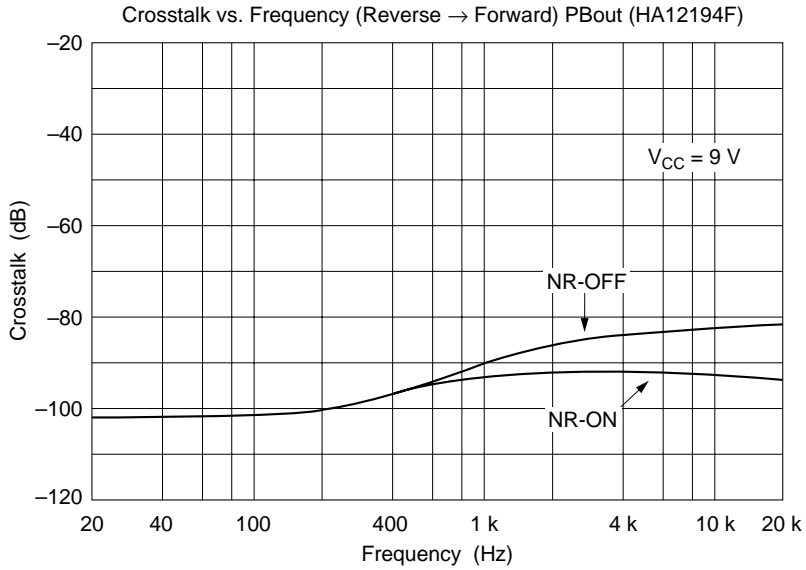

HA12192F/HA12197F/HA12212F Series

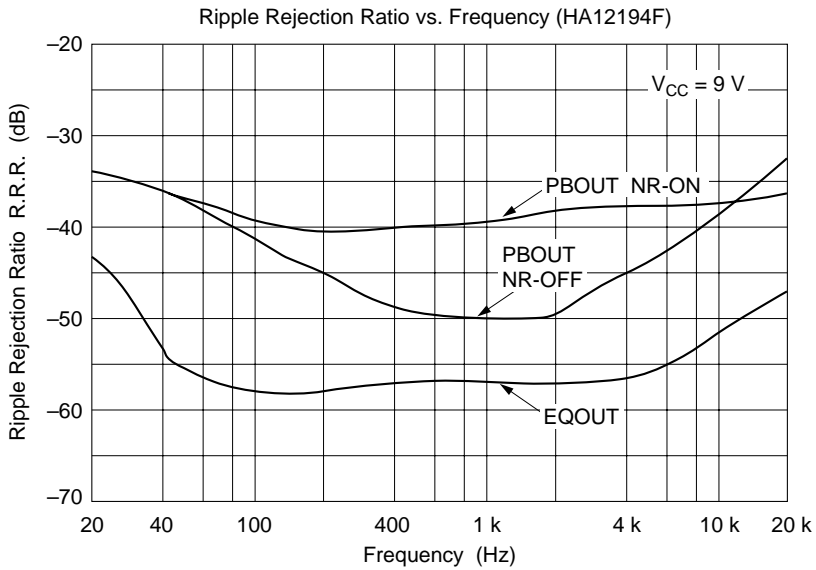
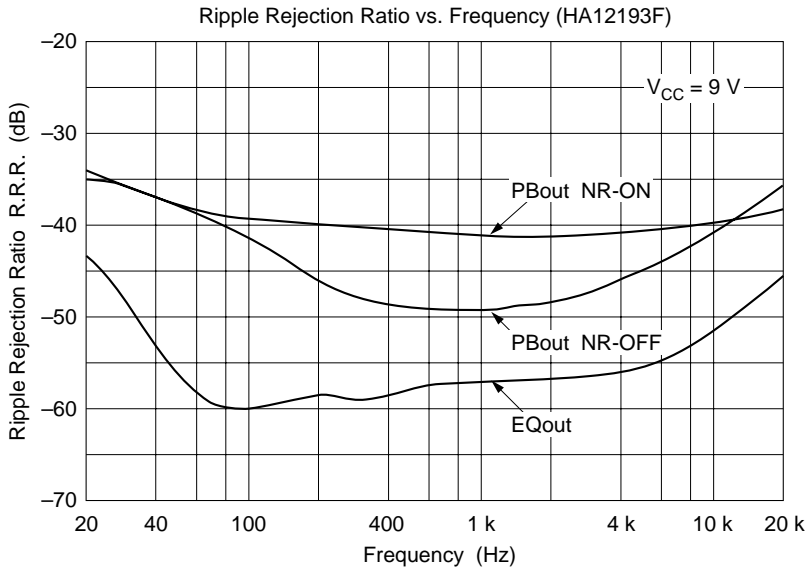

HA12192F/HA12197F/HA12212F Series

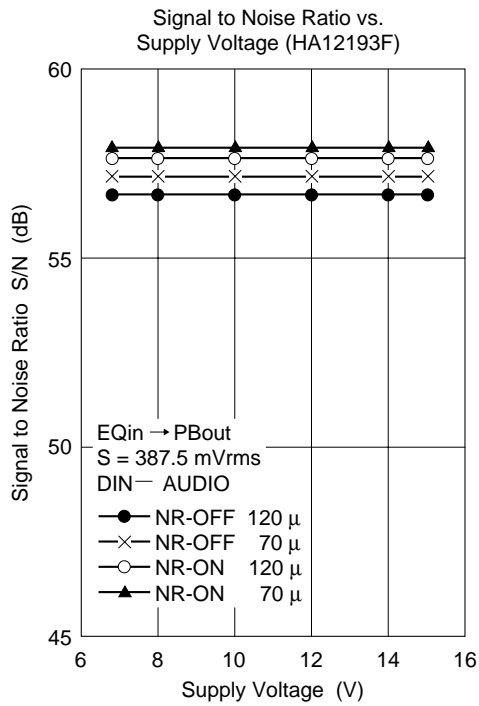
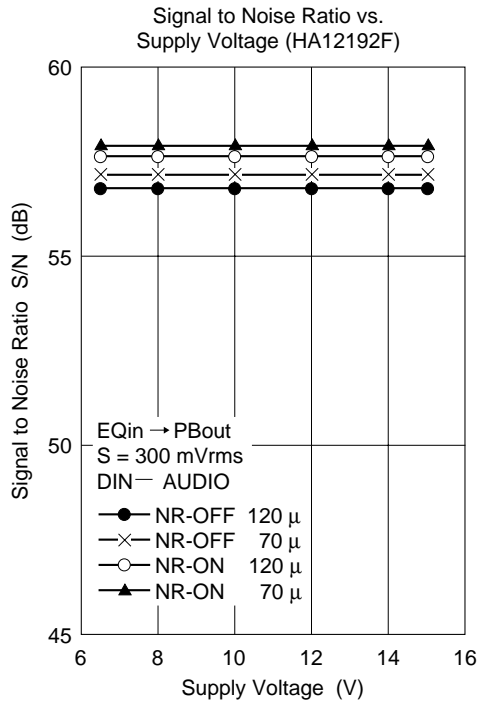

HA12192F/HA12197F/HA12212F Series

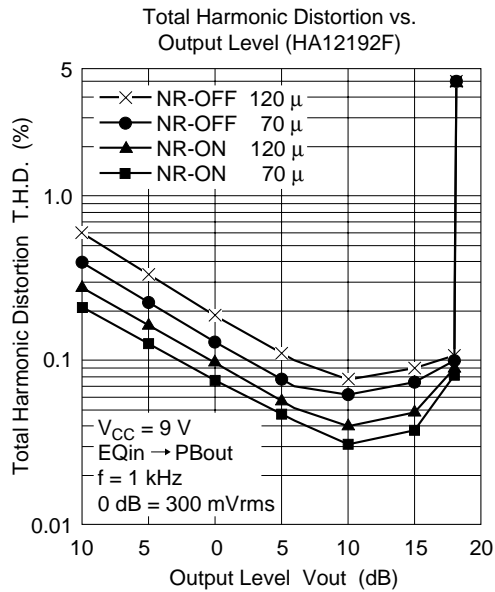
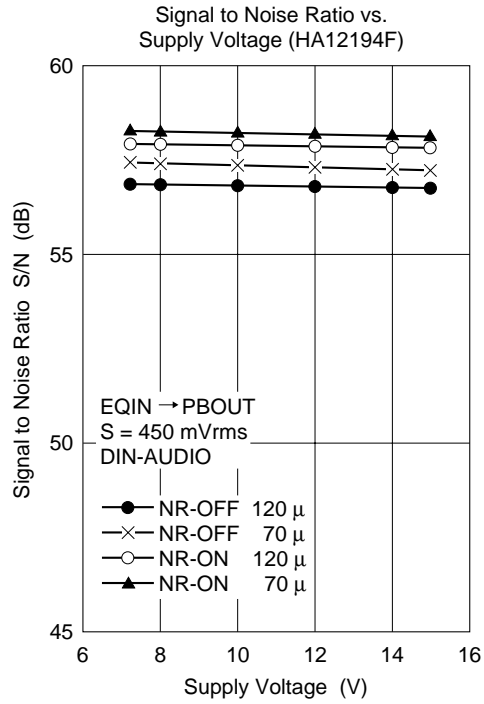

HA12192F/HA12197F/HA12212F Series

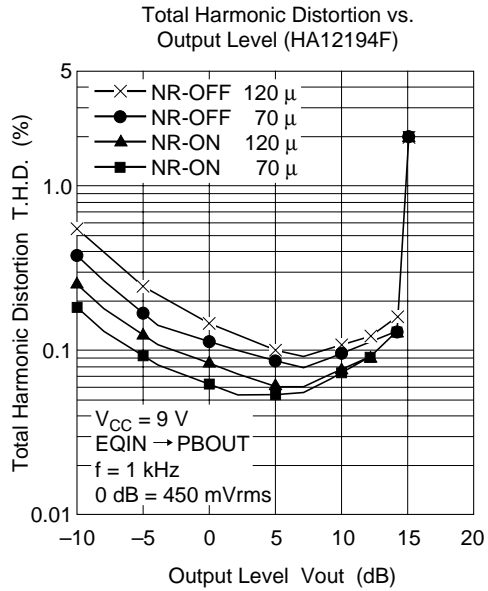
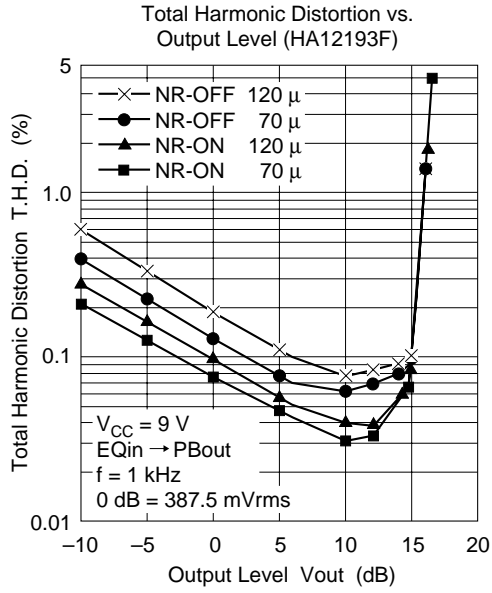

HA12192F/HA12197F/HA12212F Series

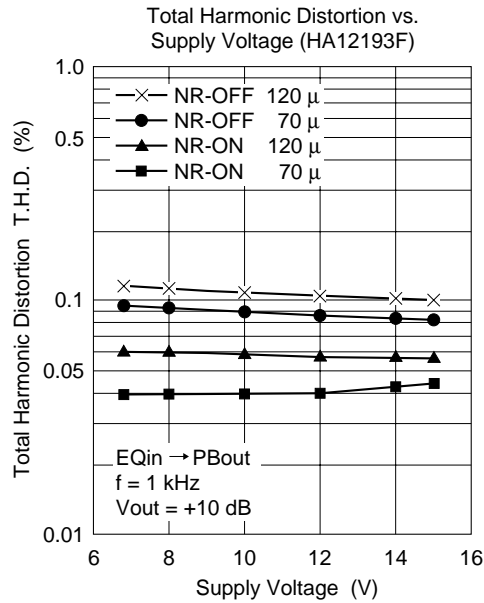
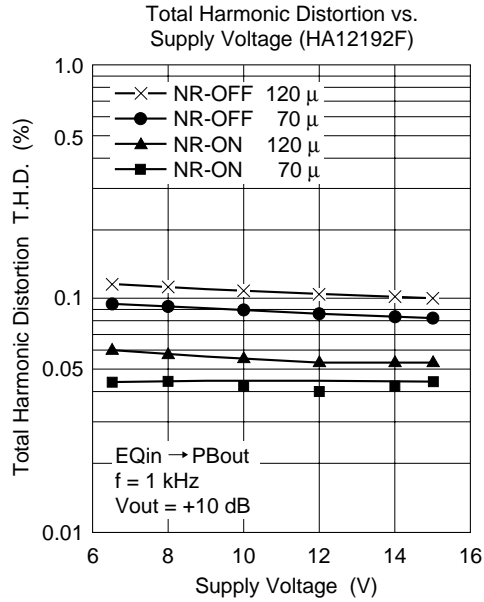

HA12192F/HA12197F/HA12212F Series

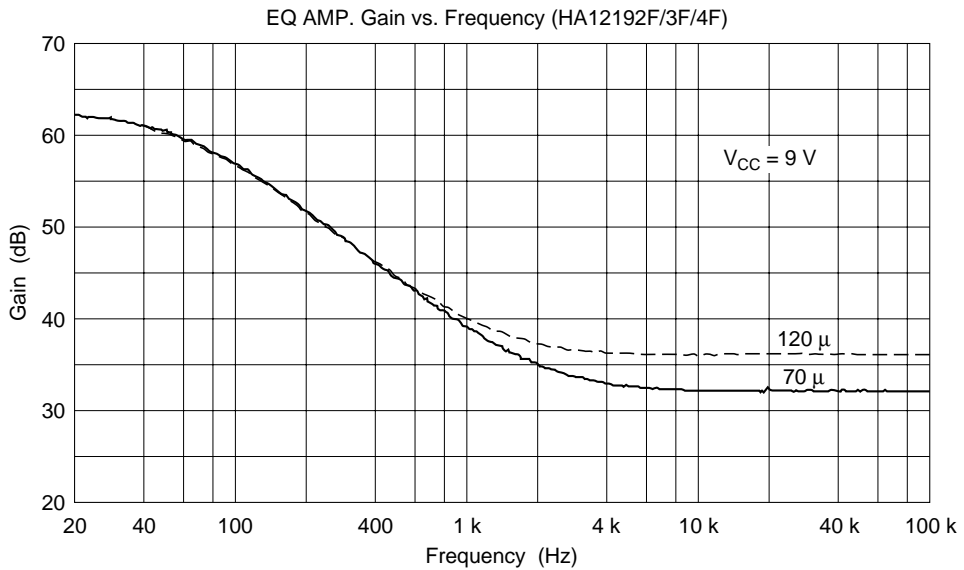
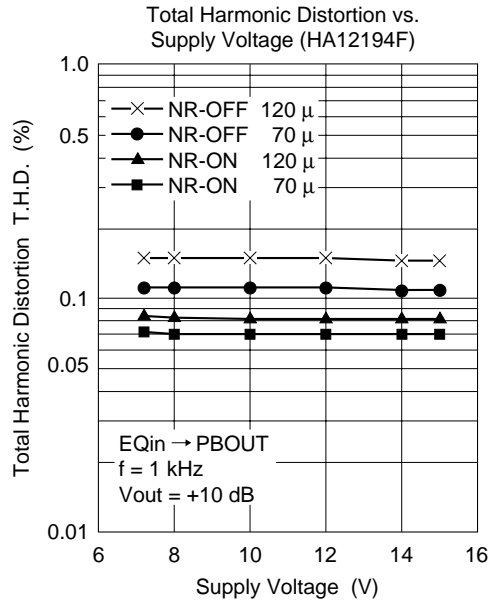

HA12192F/HA12197F/HA12212F Series

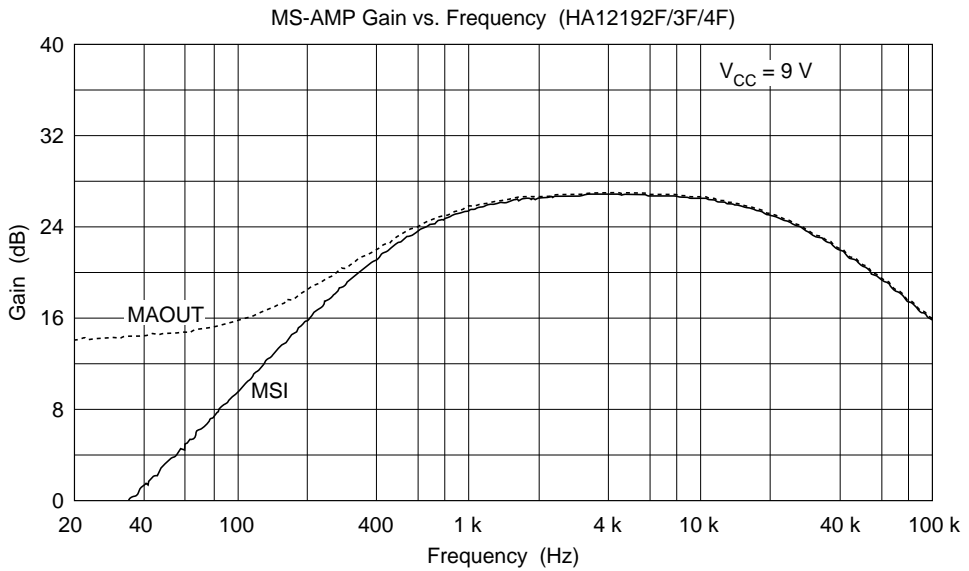
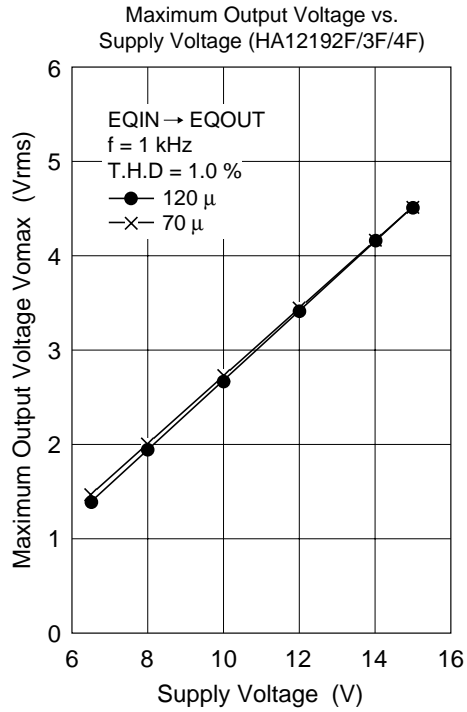

HA12192F/HA12197F/HA12212F Series

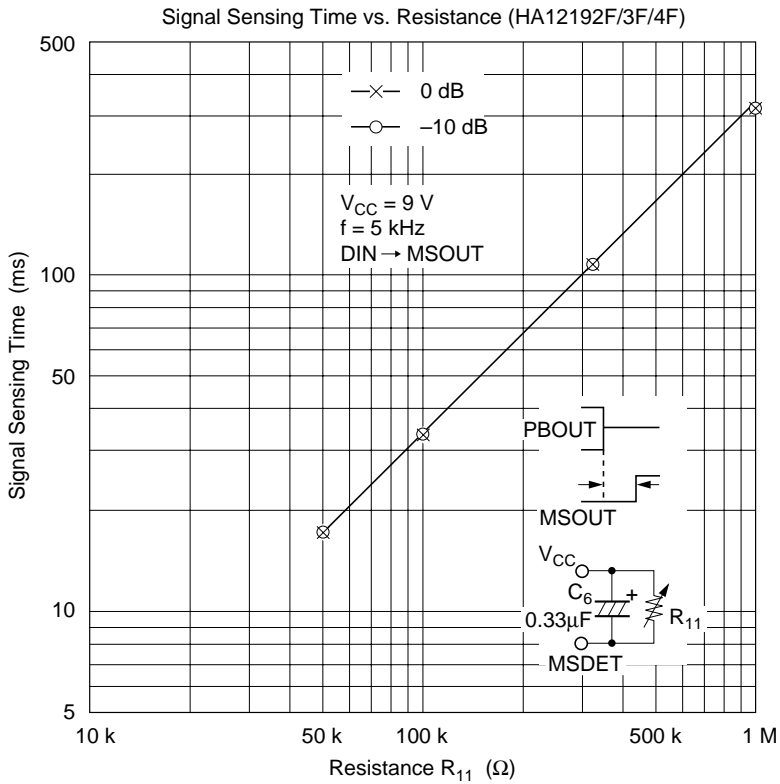
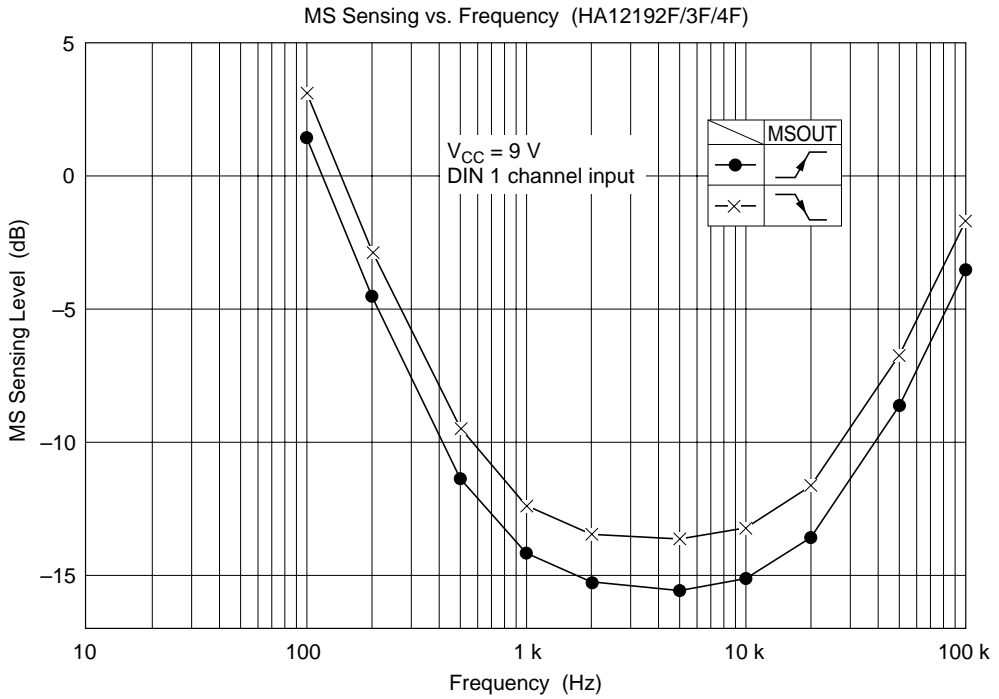

HA12192F/HA12197F/HA12212F Series

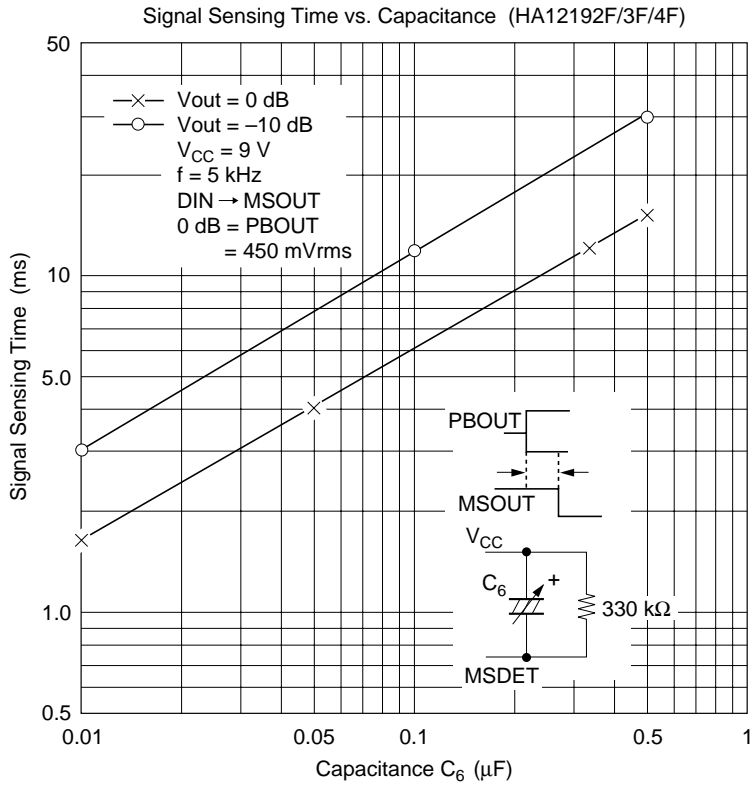

HA12192F/HA12197F/HA12212F Series

- HA12197F Series

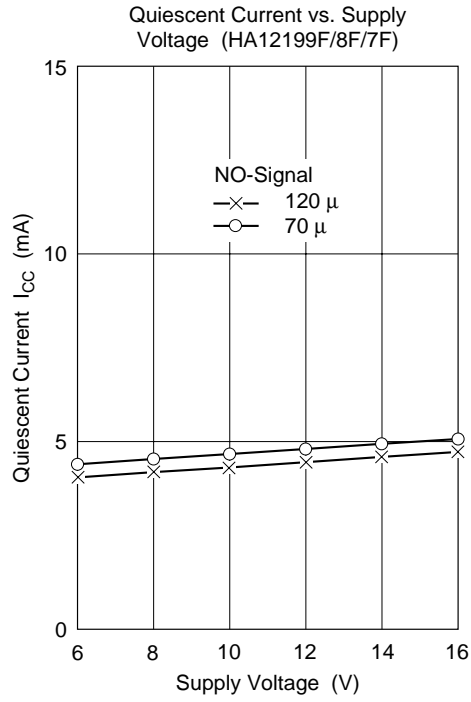

HA12192F/HA12197F/HA12212F Series

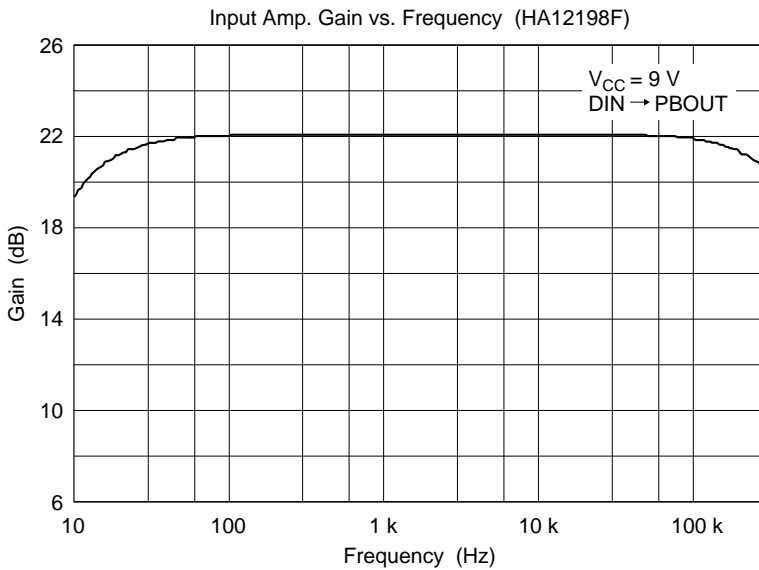
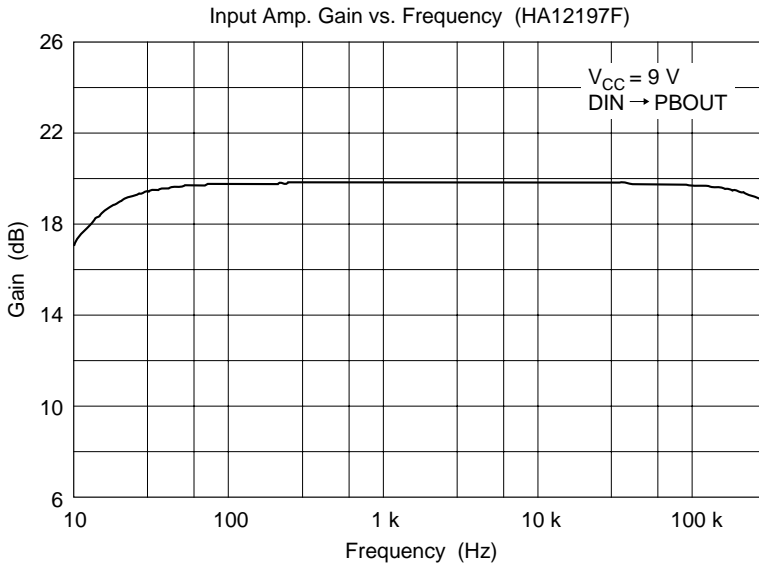

HA12192F/HA12197F/HA12212F Series

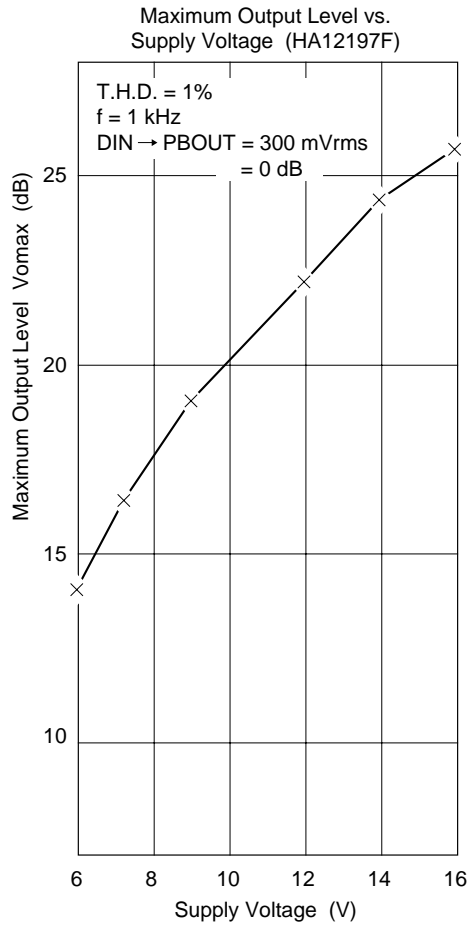
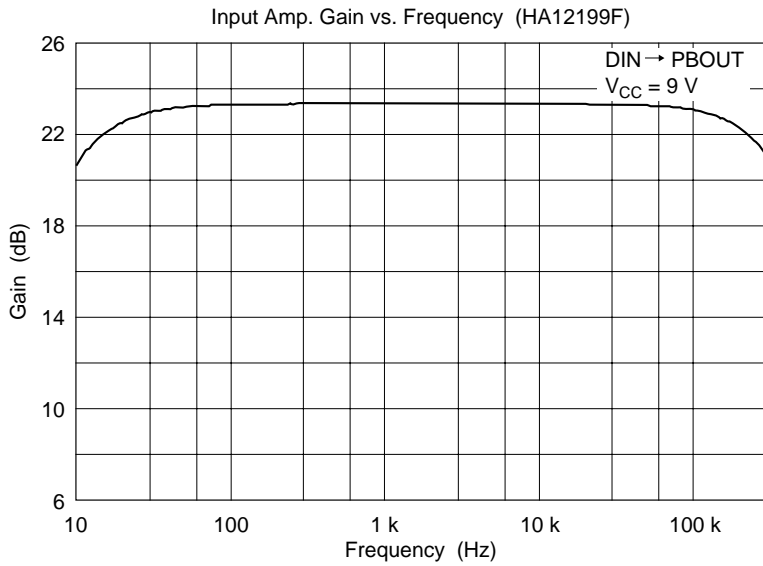

HA12192F/HA12197F/HA12212F Series

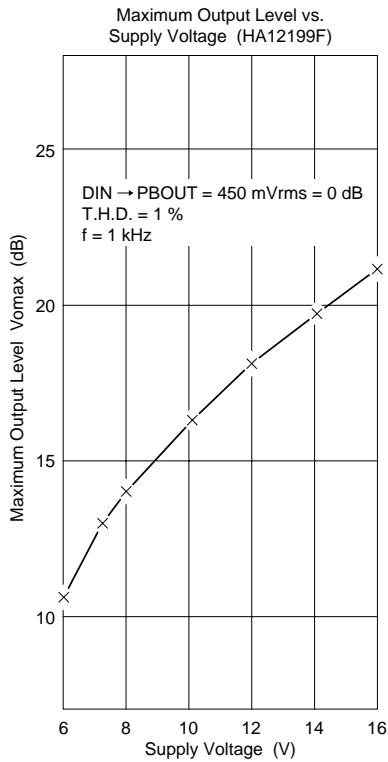
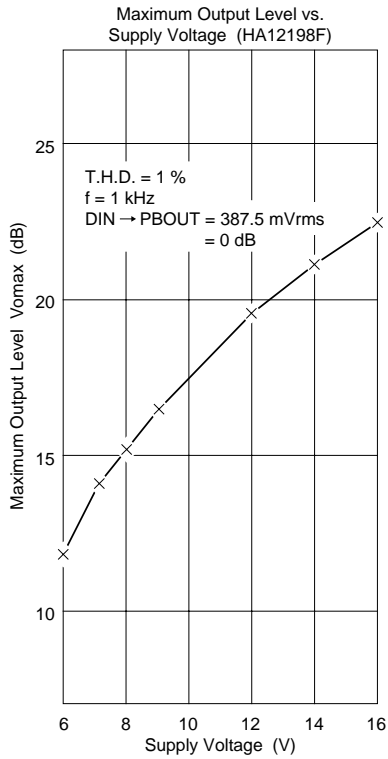

HA12192F/HA12197F/HA12212F Series

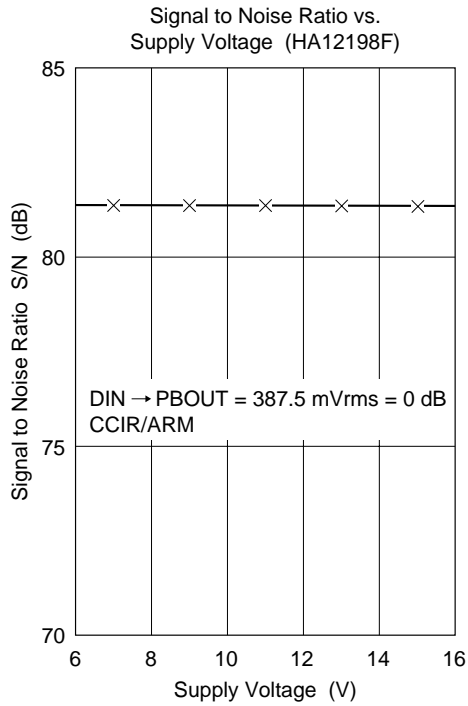
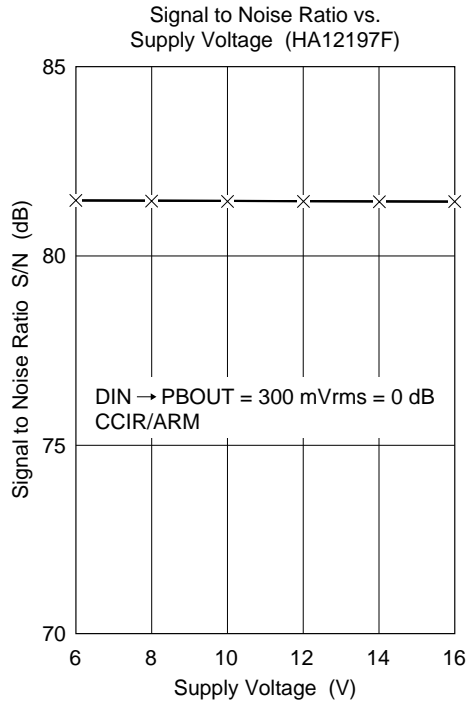

HA12192F/HA12197F/HA12212F Series

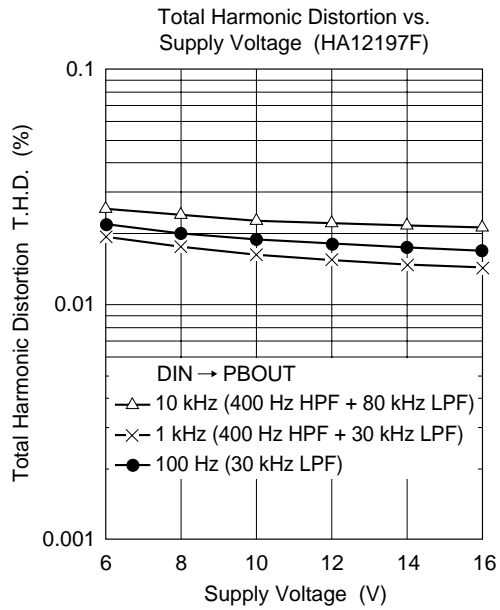
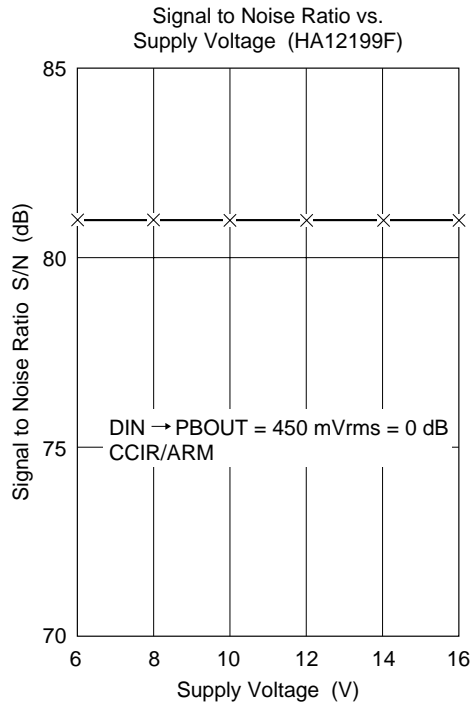

HA12192F/HA12197F/HA12212F Series

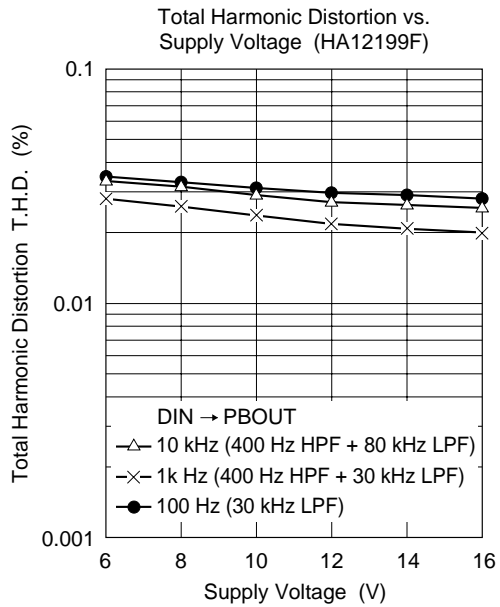
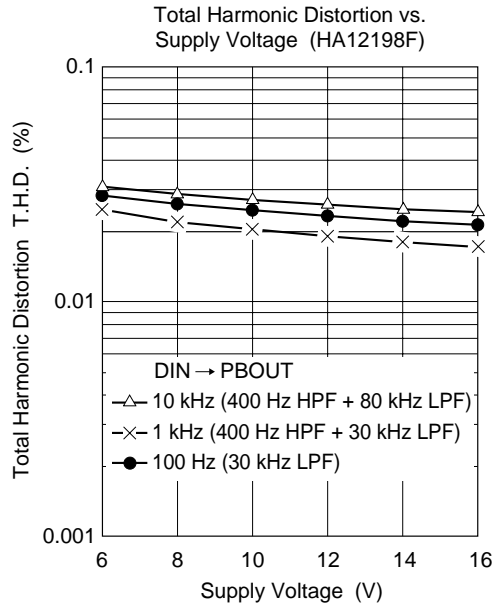

HA12192F/HA12197F/HA12212F Series

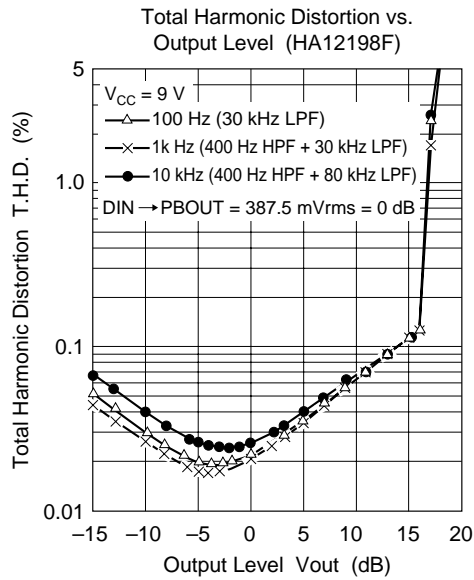
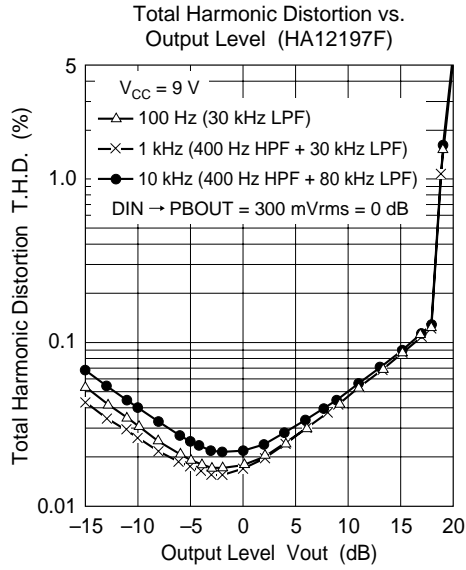

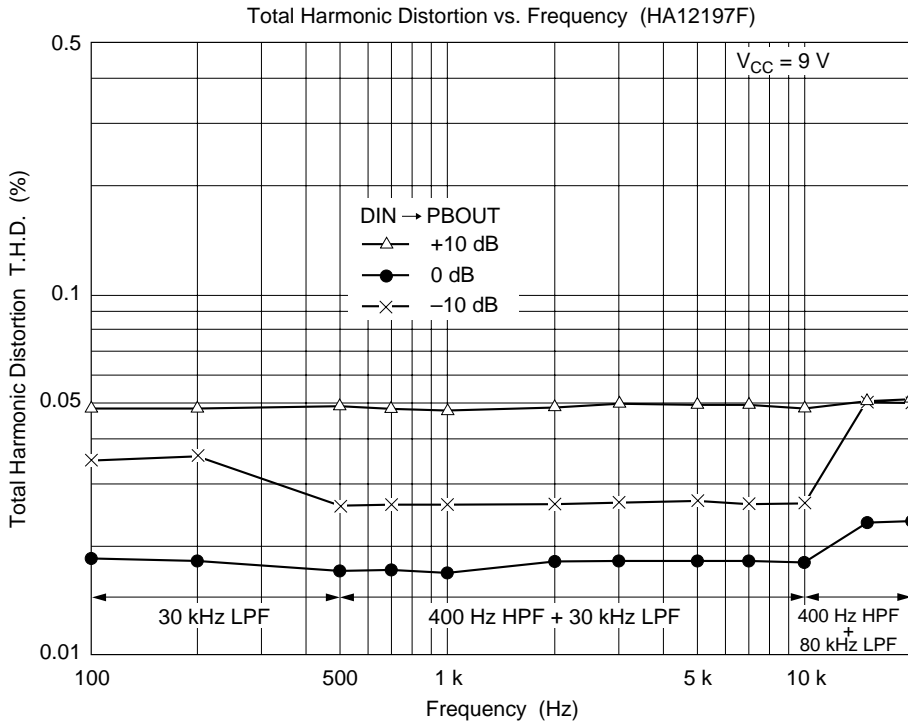
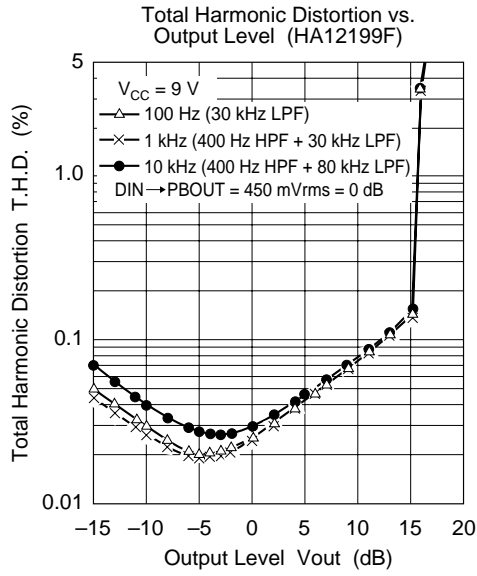

HA12192F/HA12197F/HA12212F Series

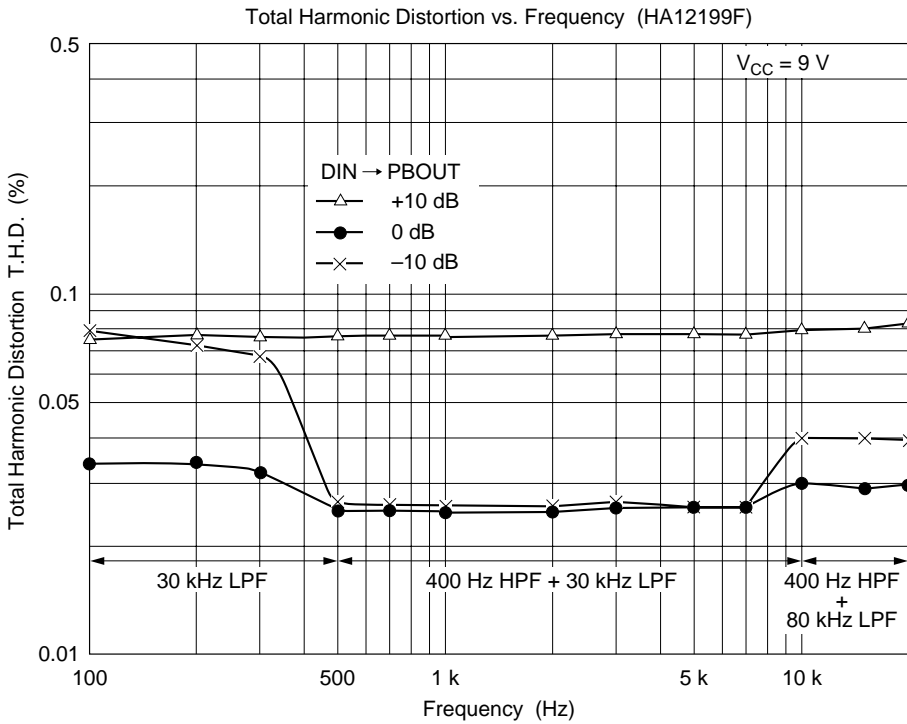
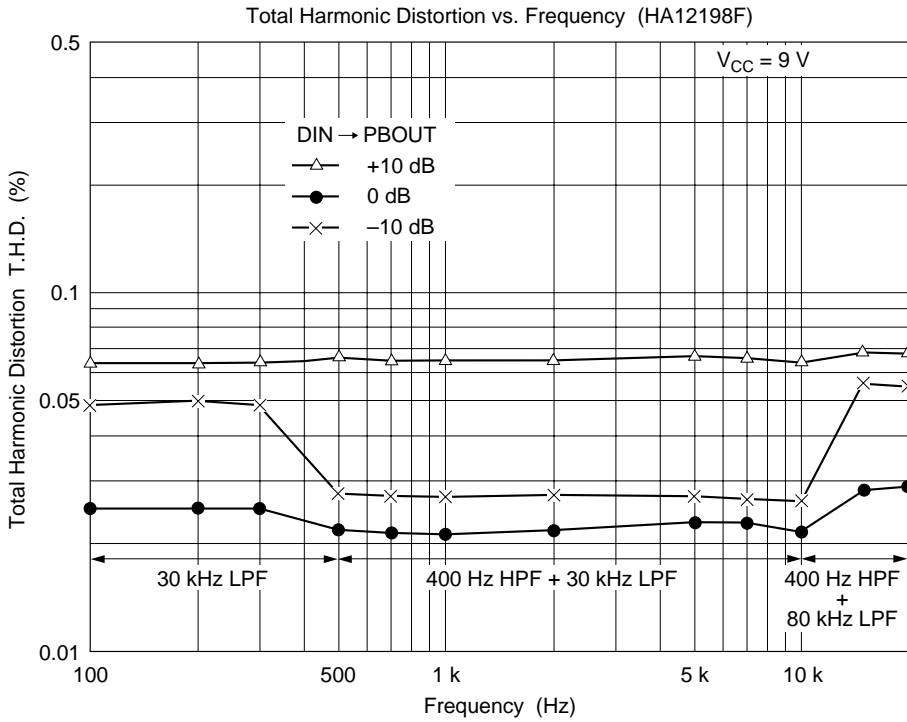

HA12192F/HA12197F/HA12212F Series

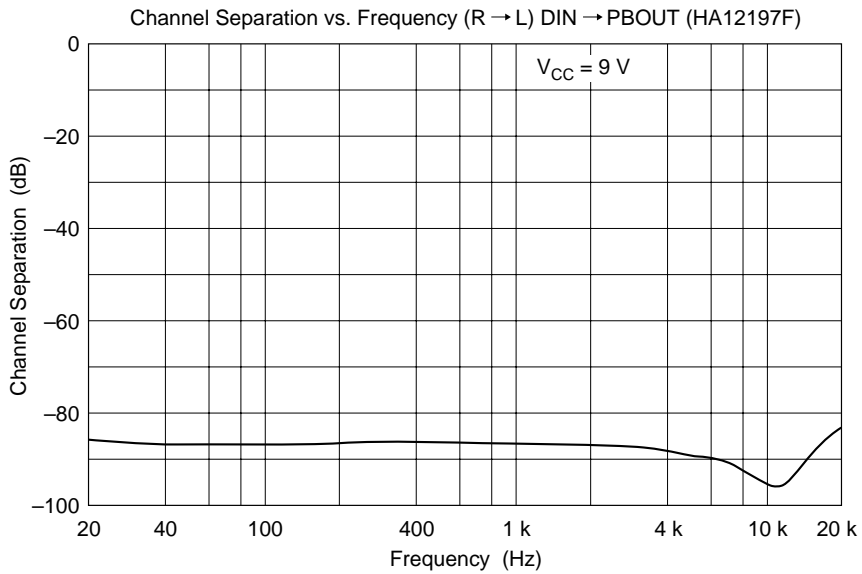
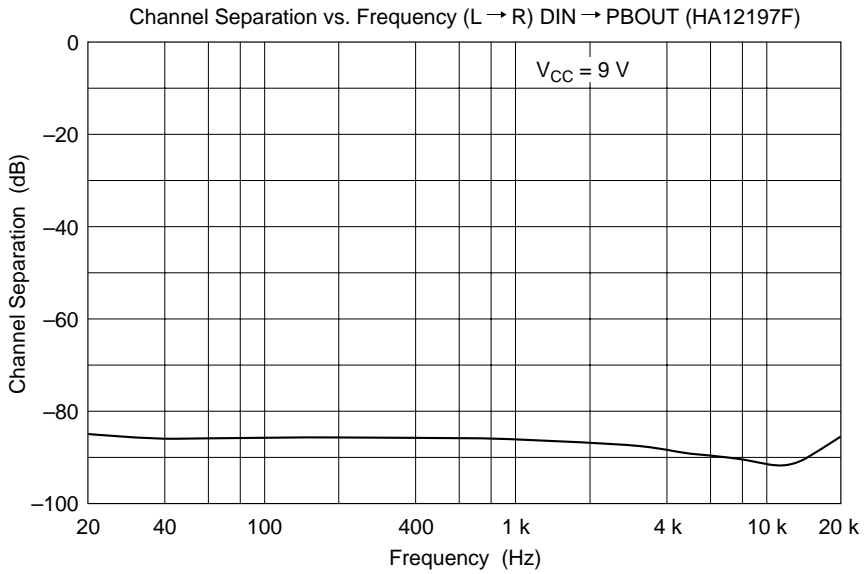

HA12192F/HA12197F/HA12212F Series

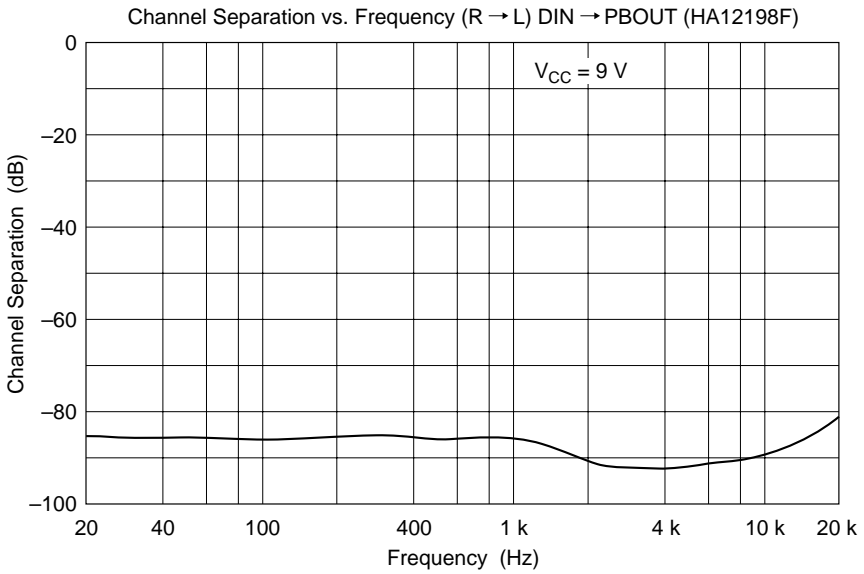
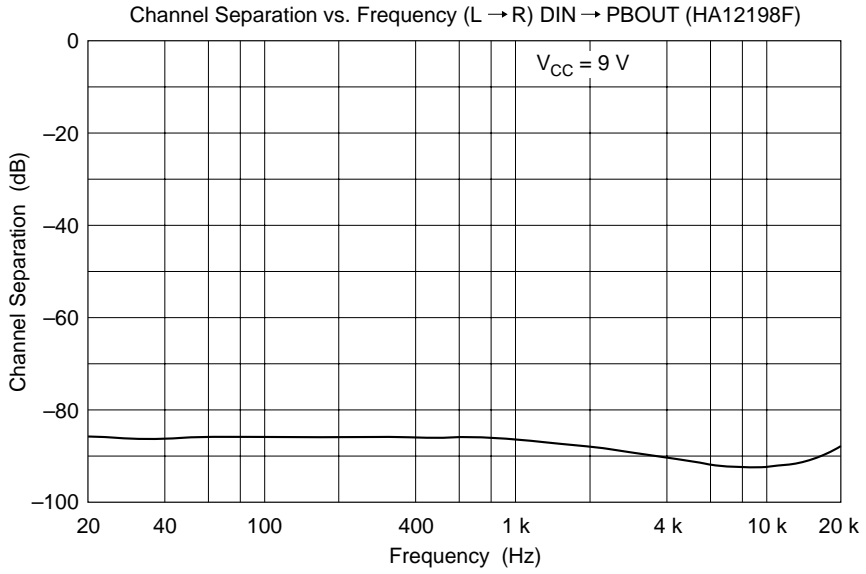

HA12192F/HA12197F/HA12212F Series

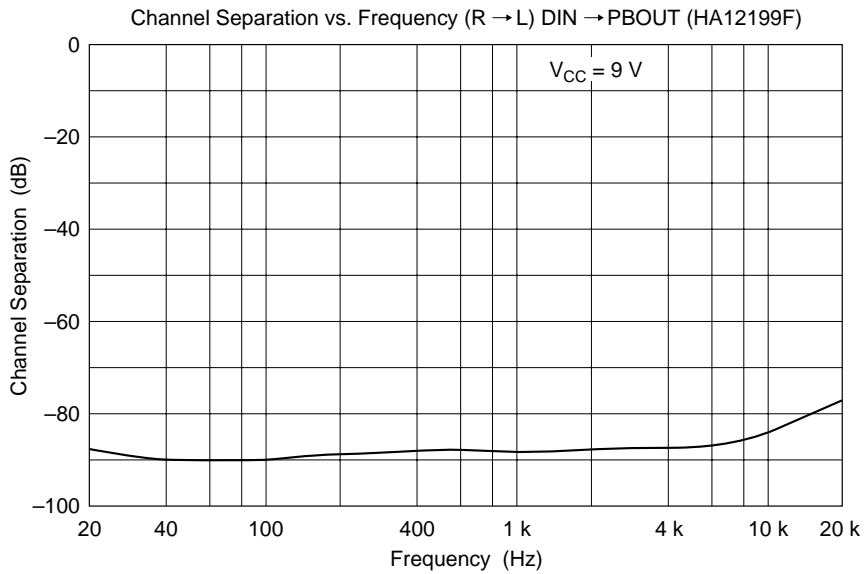
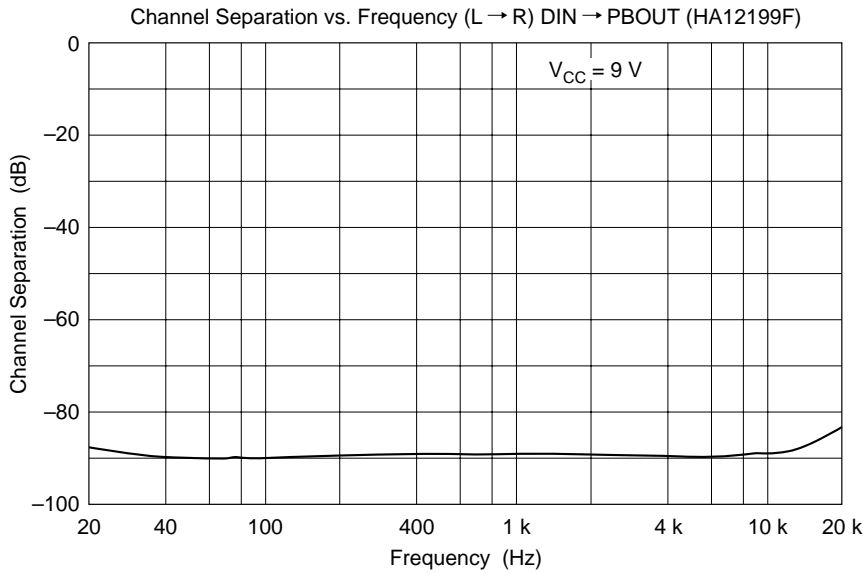

HA12192F/HA12197F/HA12212F Series

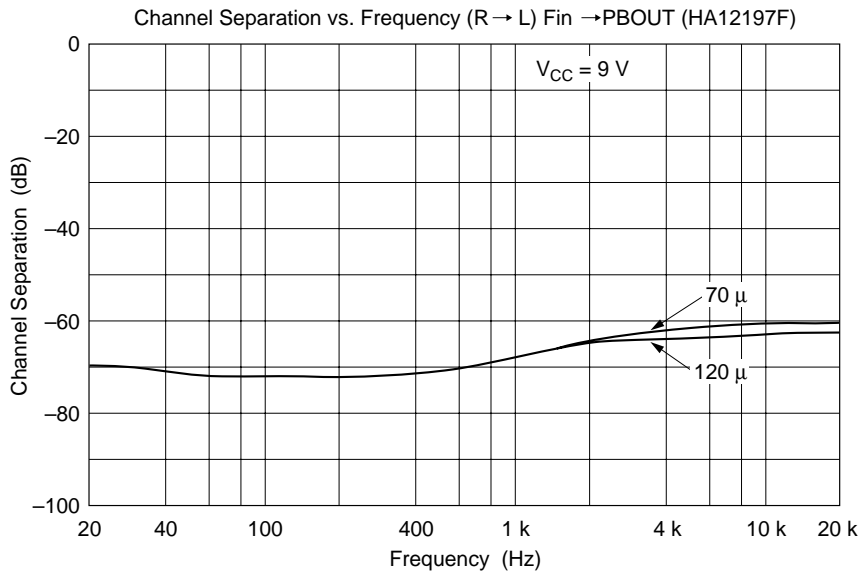
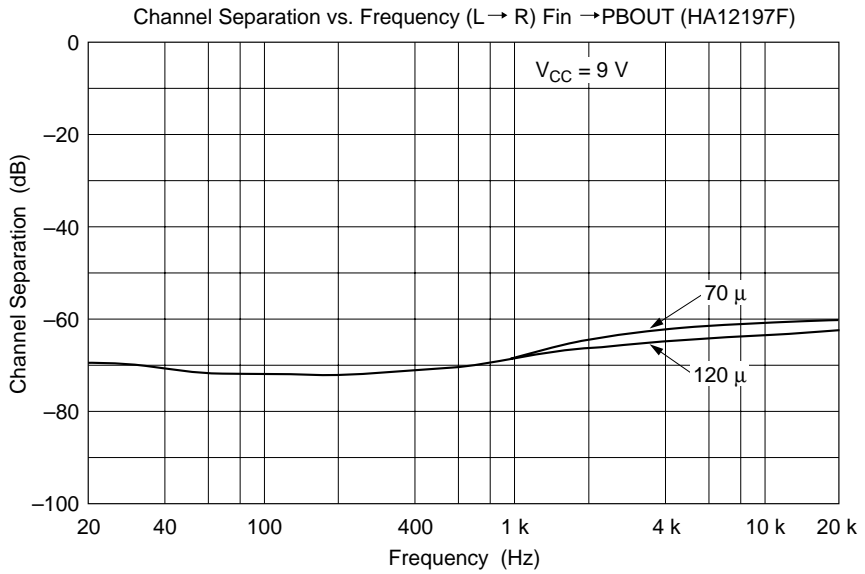

HA12192F/HA12197F/HA12212F Series

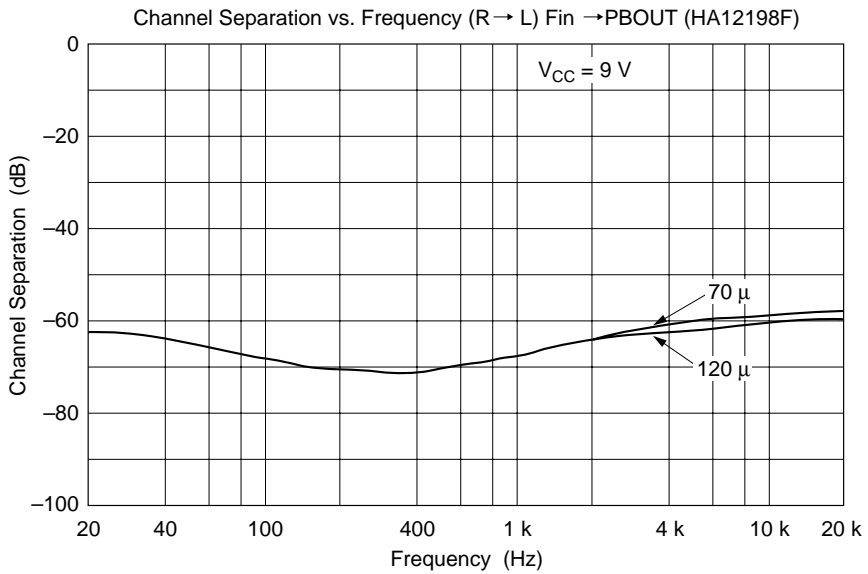
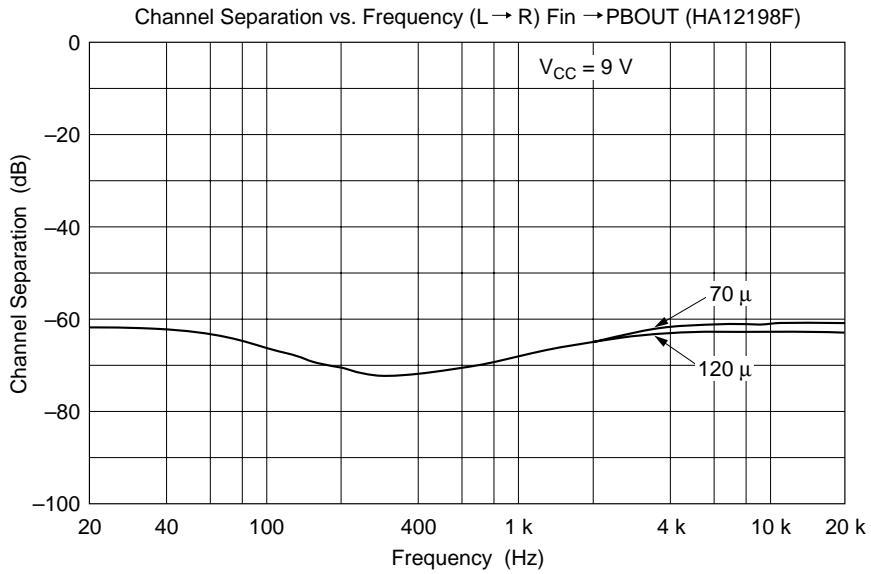

HA12192F/HA12197F/HA12212F Series

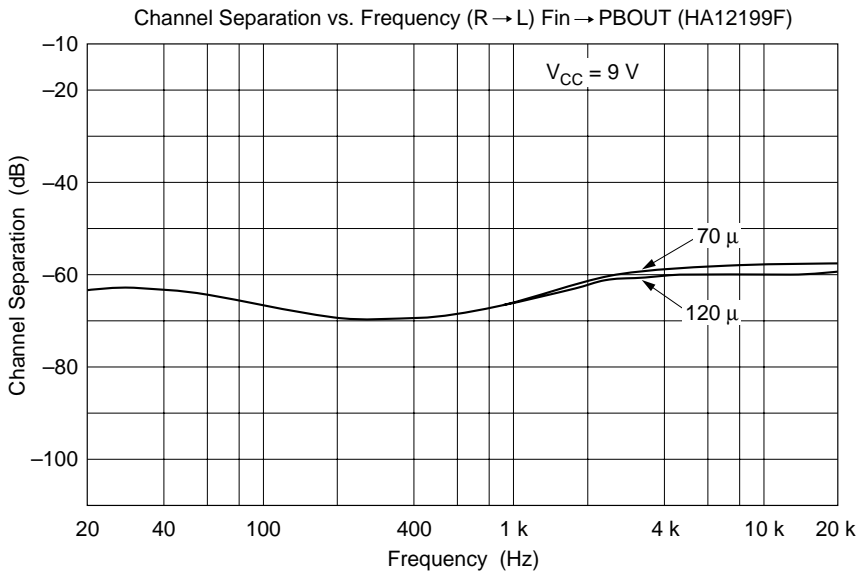
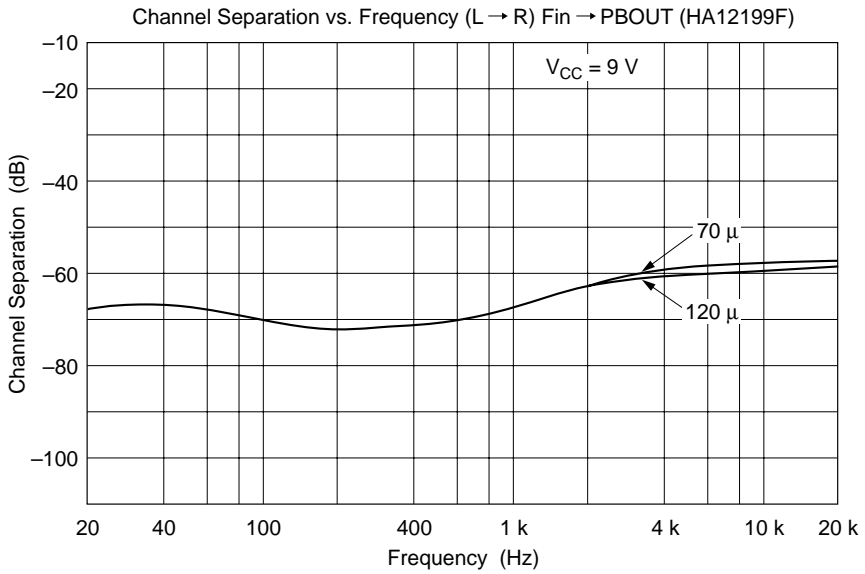

HA12192F/HA12197F/HA12212F Series

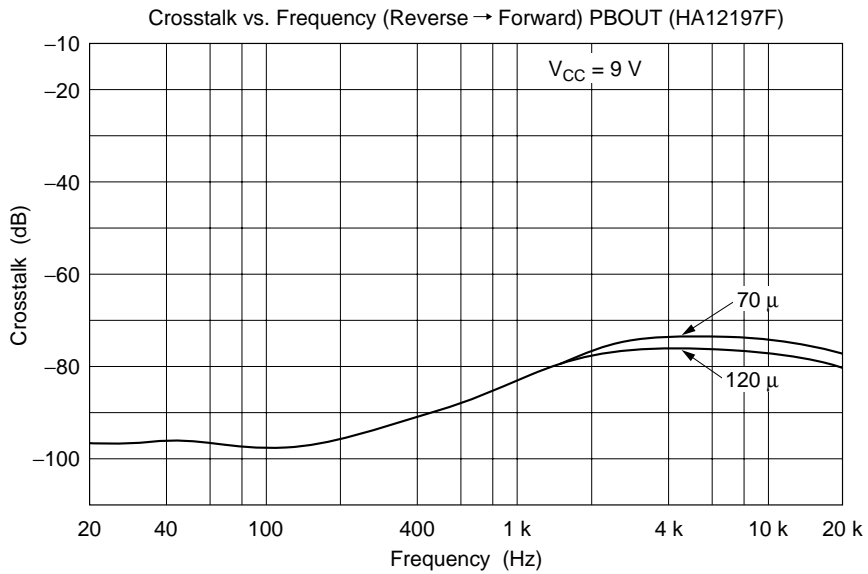
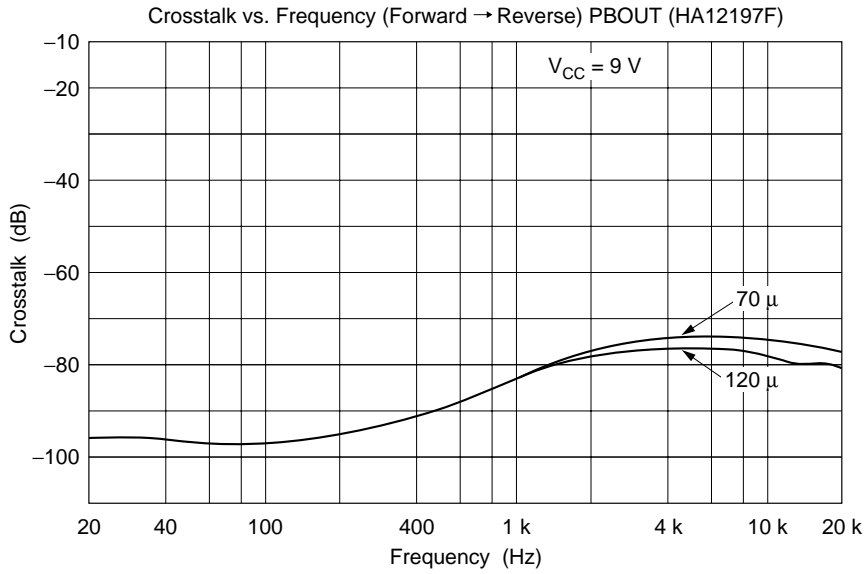

HA12192F/HA12197F/HA12212F Series

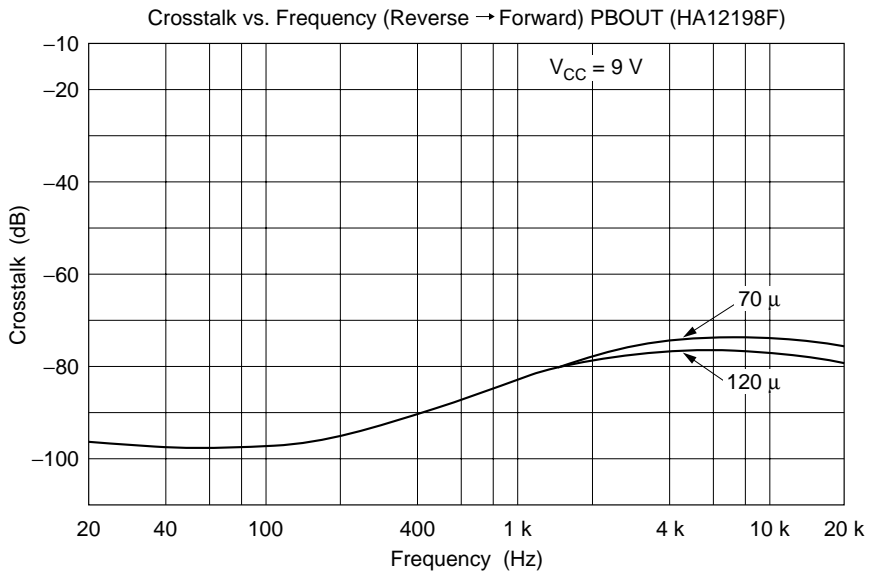
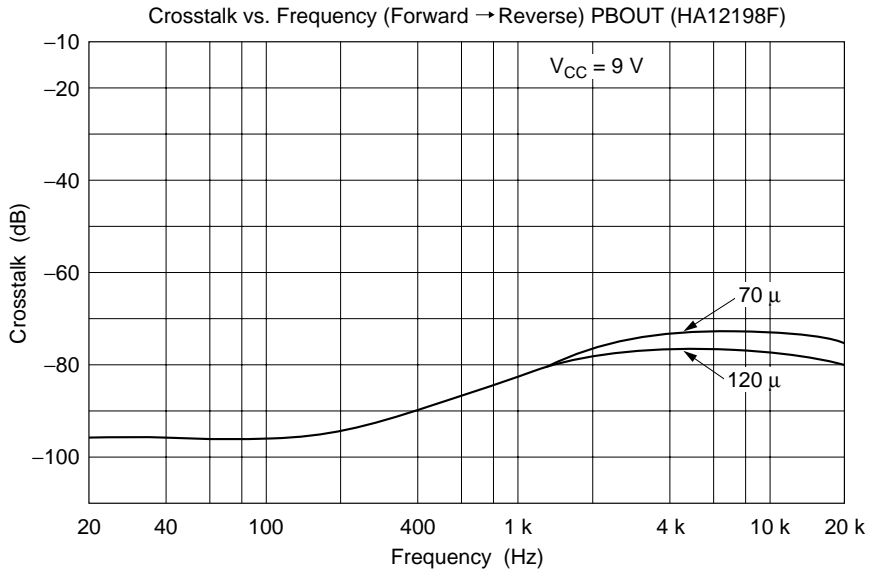

HA12192F/HA12197F/HA12212F Series

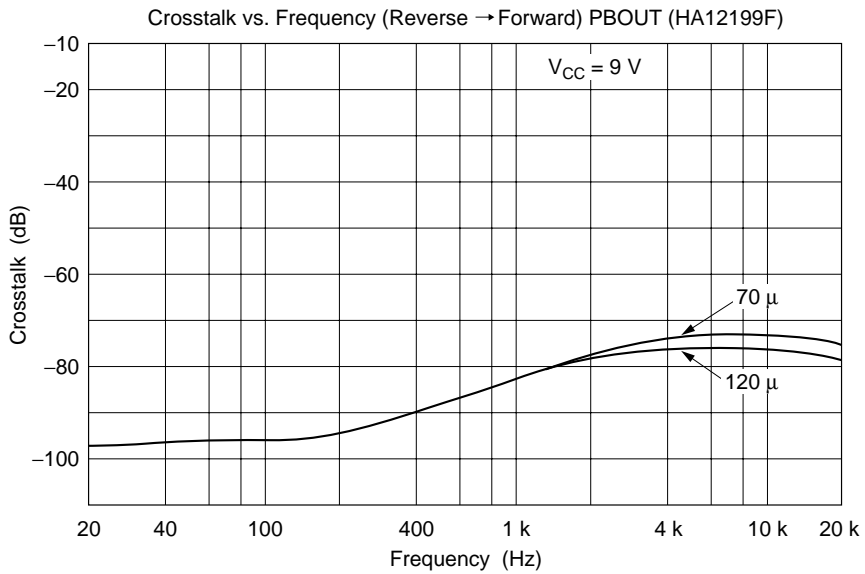
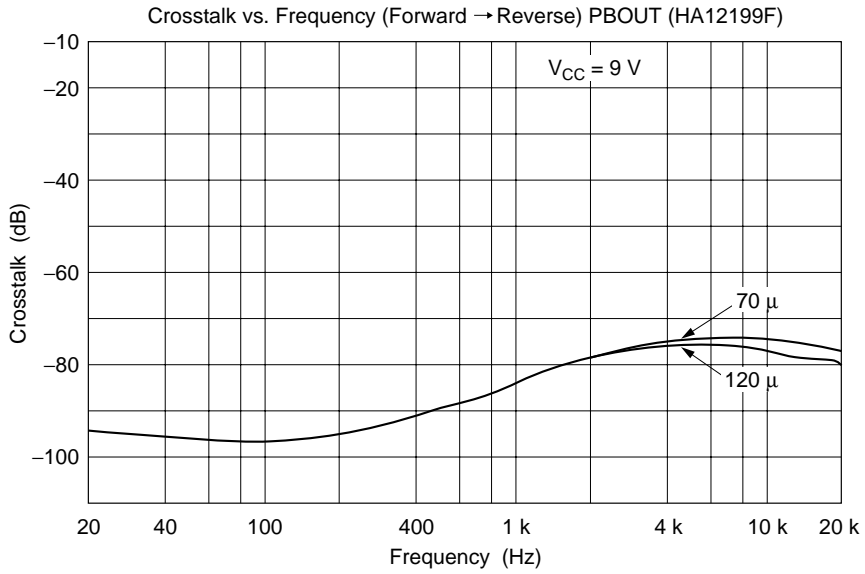

HA12192F/HA12197F/HA12212F Series

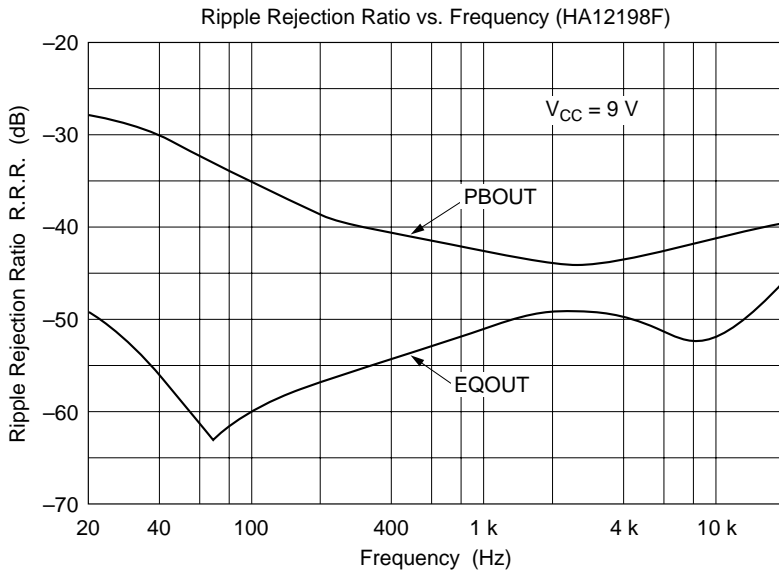
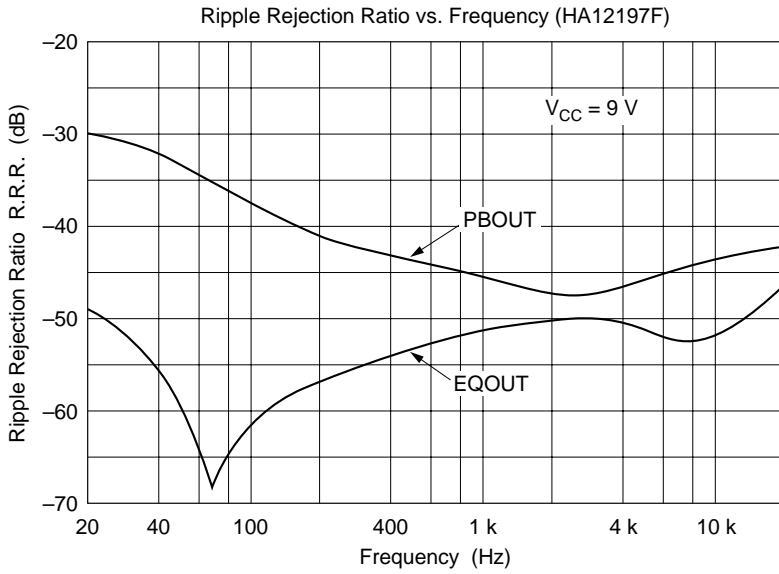

HA12192F/HA12197F/HA12212F Series

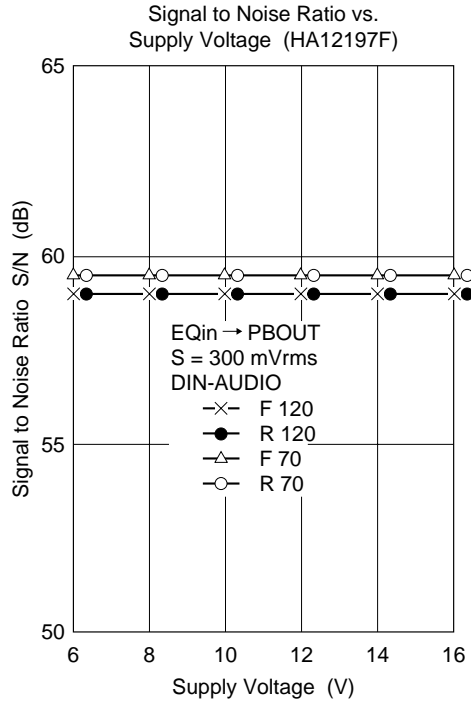
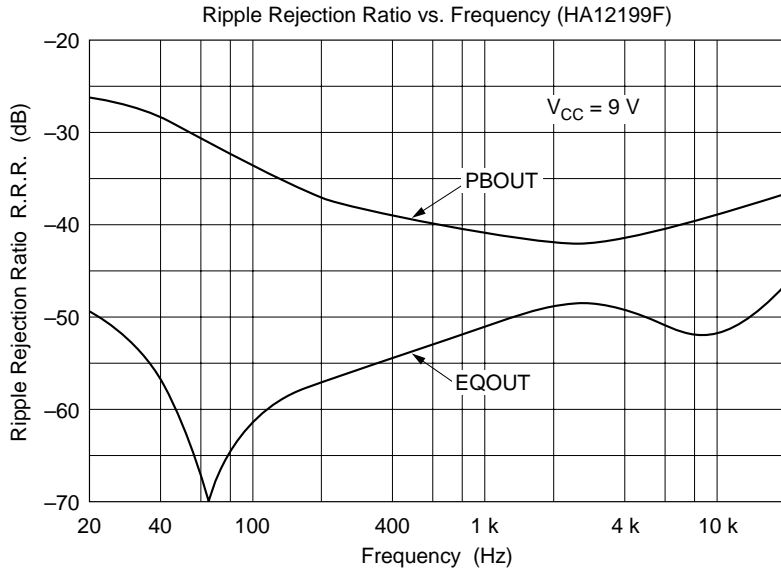

HA12192F/HA12197F/HA12212F Series

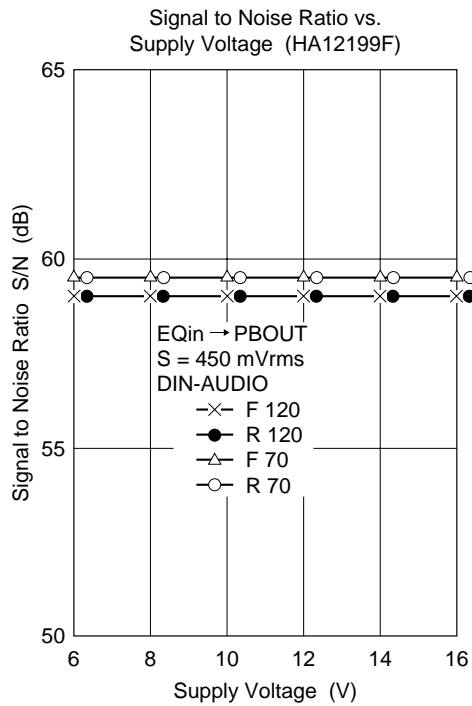
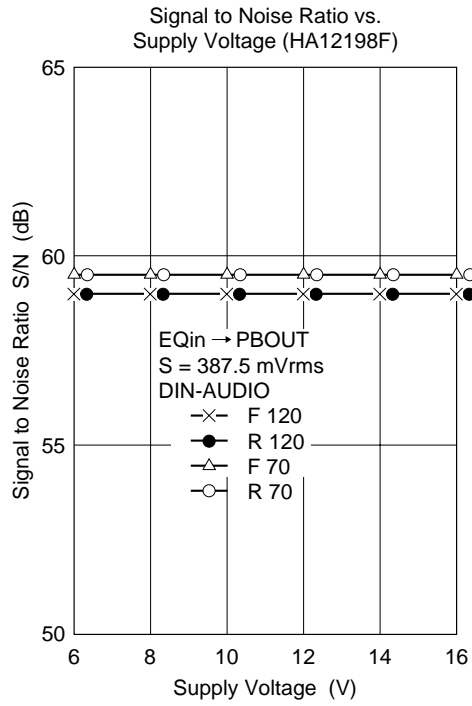

HA12192F/HA12197F/HA12212F Series

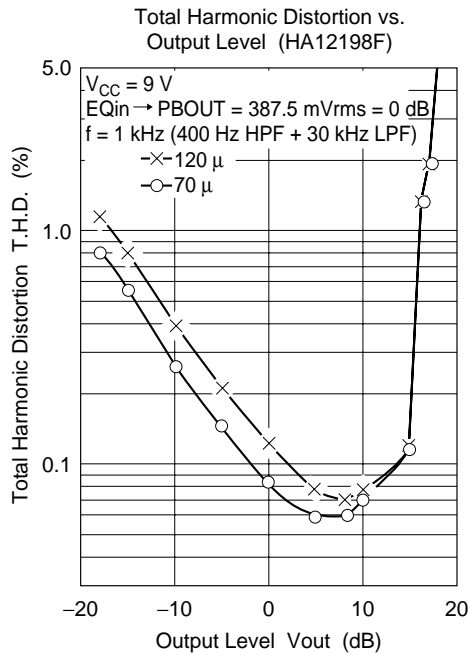
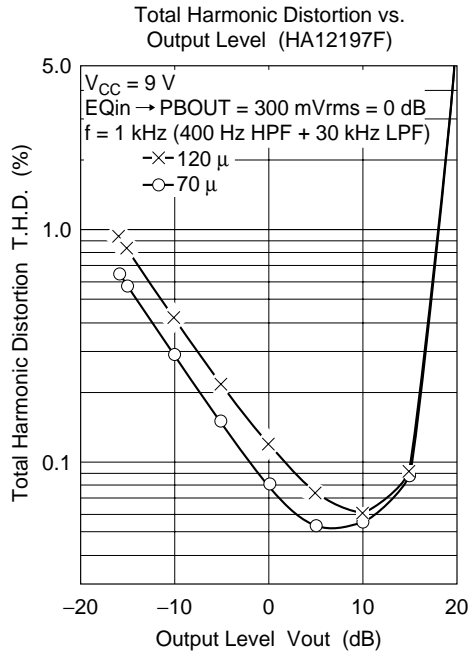

HA12192F/HA12197F/HA12212F Series

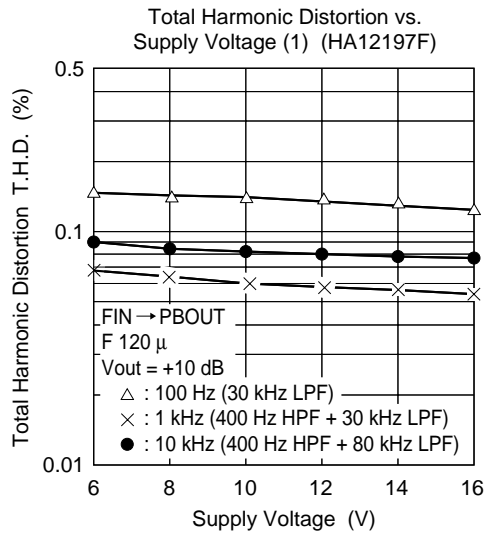
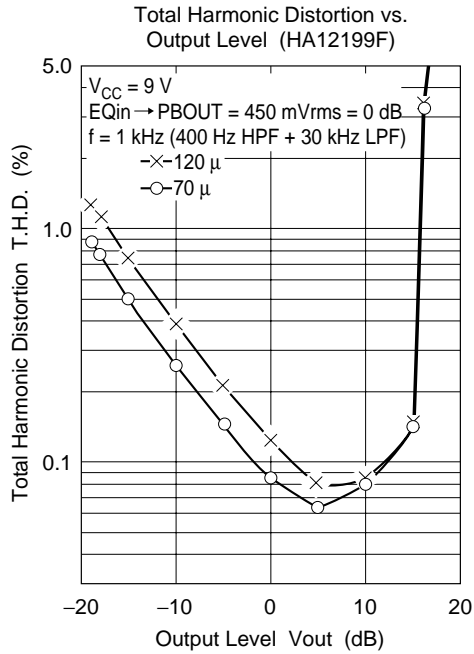

HA12192F/HA12197F/HA12212F Series

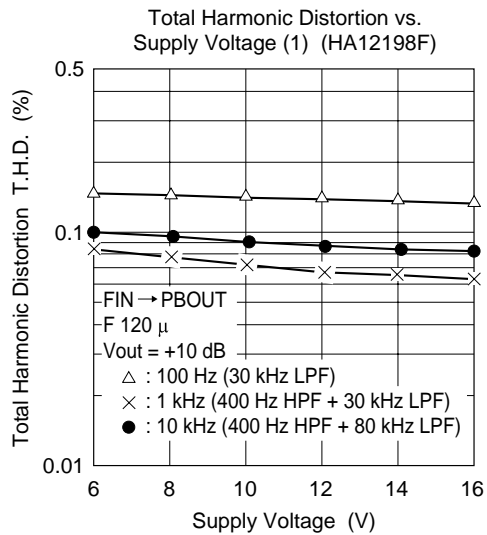
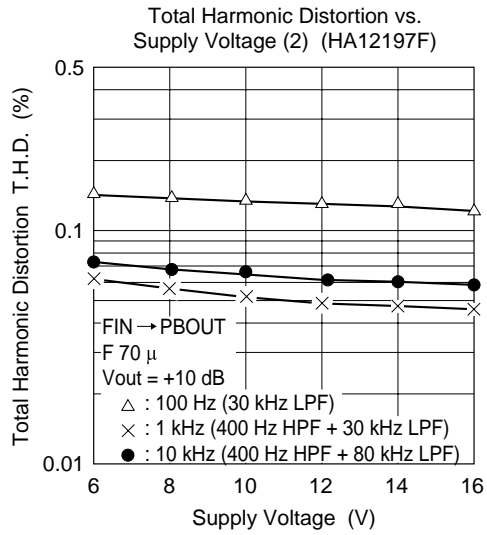

HA12192F/HA12197F/HA12212F Series

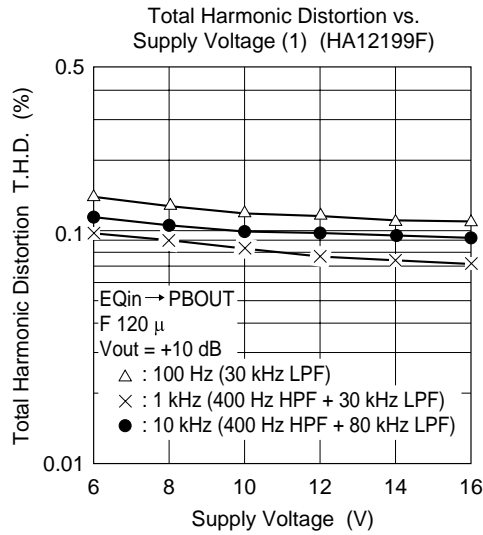
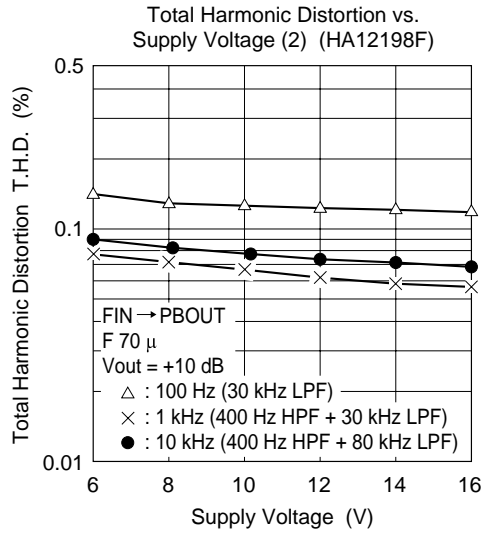

HA12192F/HA12197F/HA12212F Series

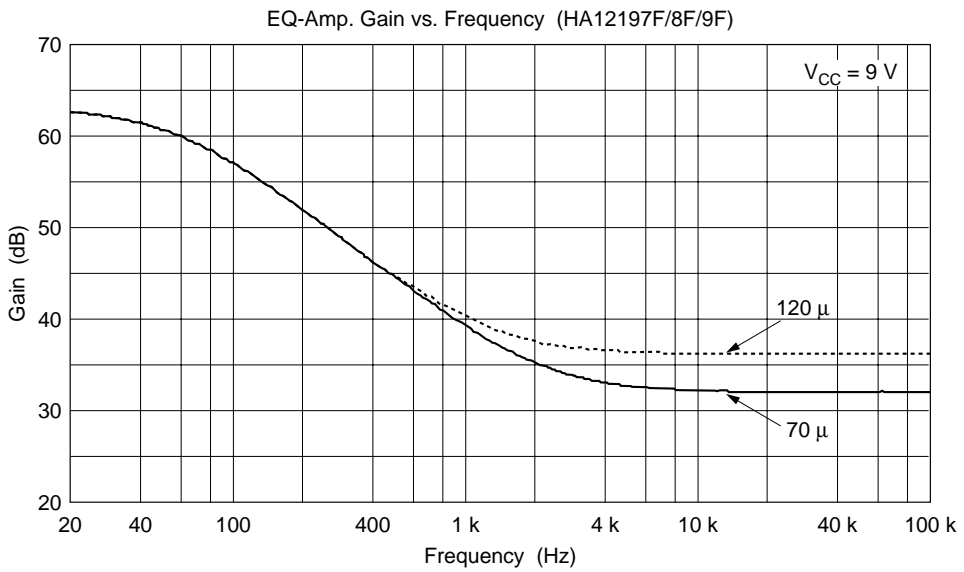
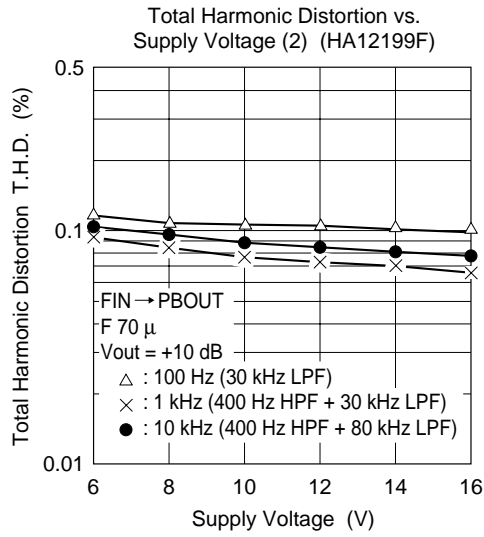

HA12192F/HA12197F/HA12212F Series

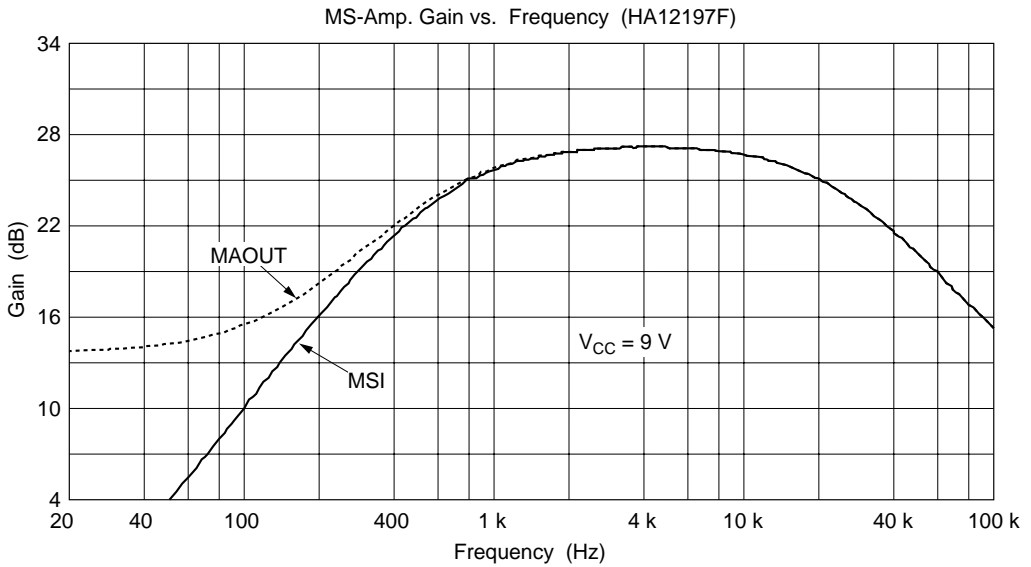
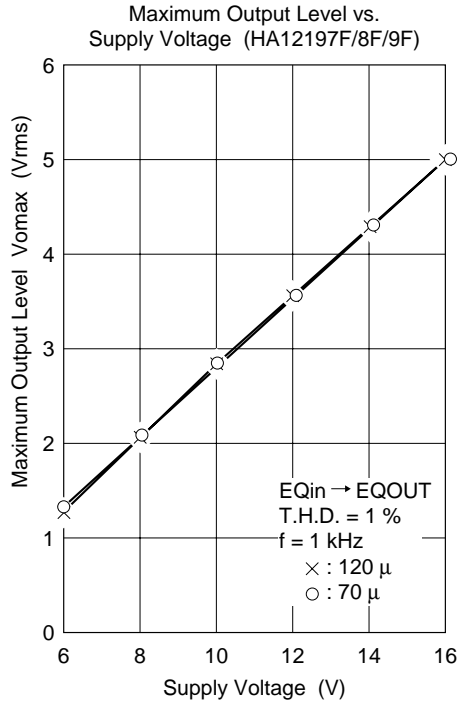

HA12192F/HA12197F/HA12212F Series

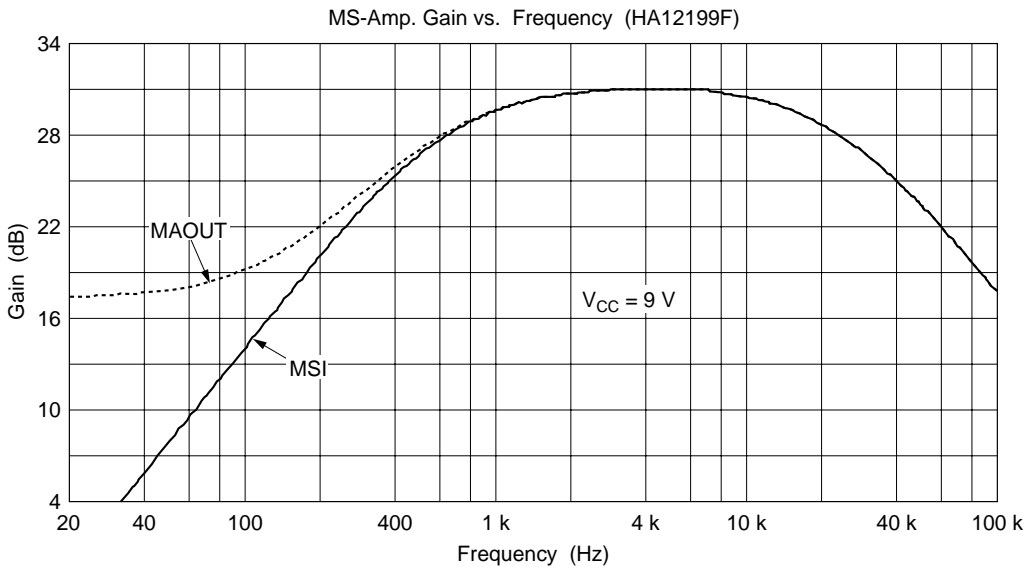
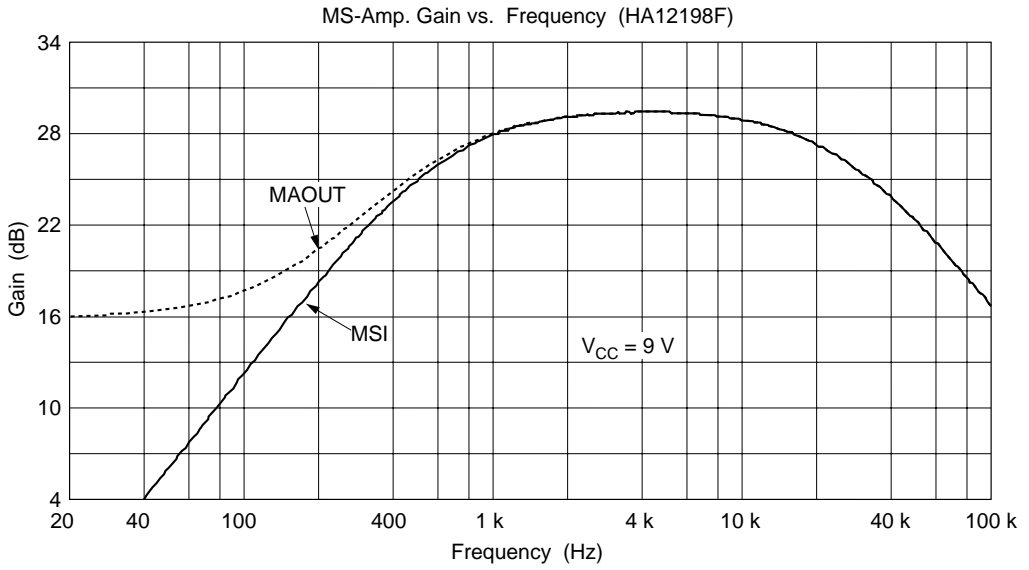

HA12192F/HA12197F/HA12212F Series

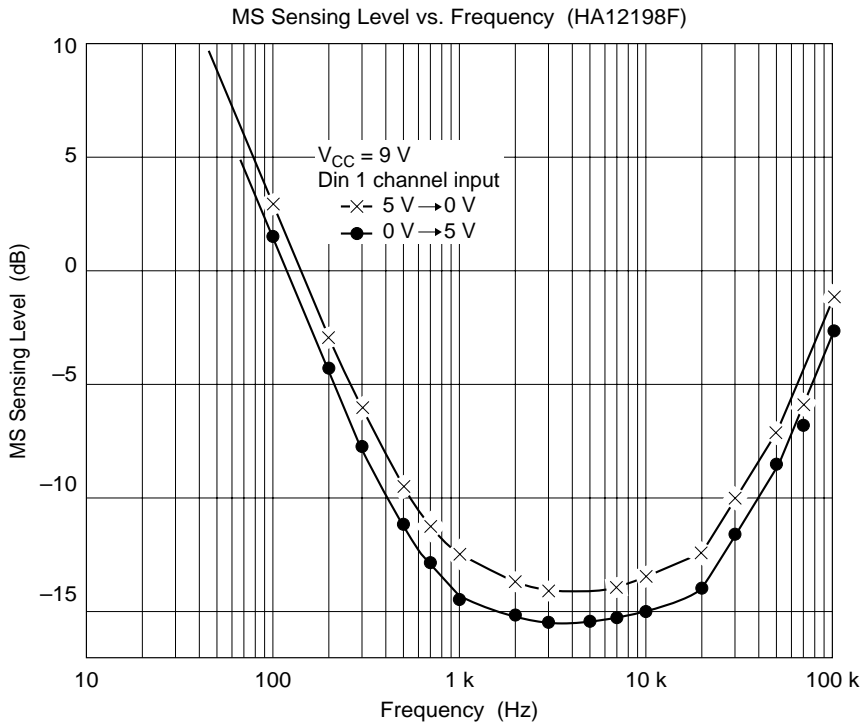
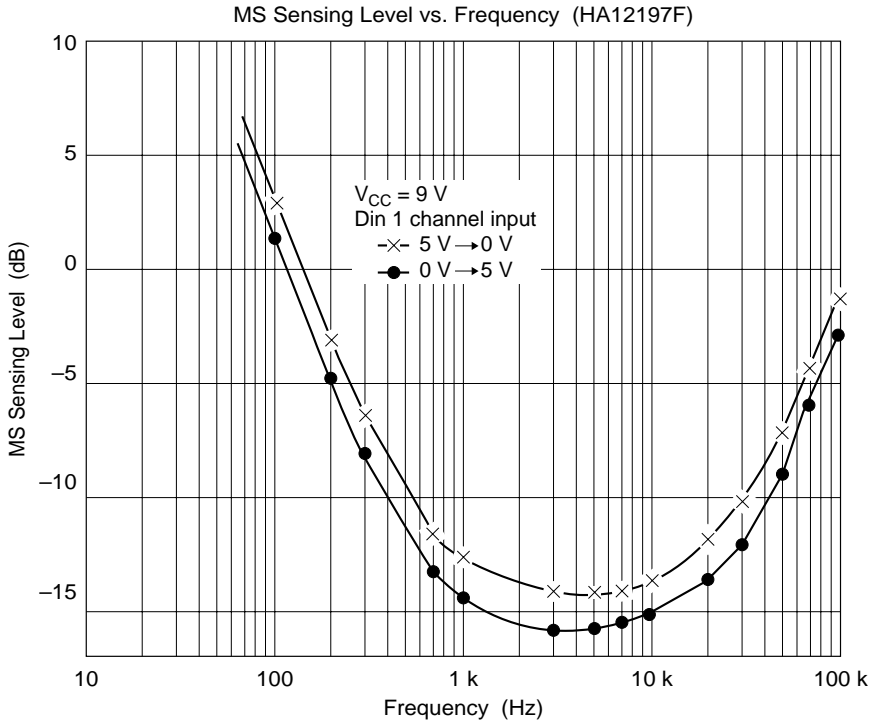

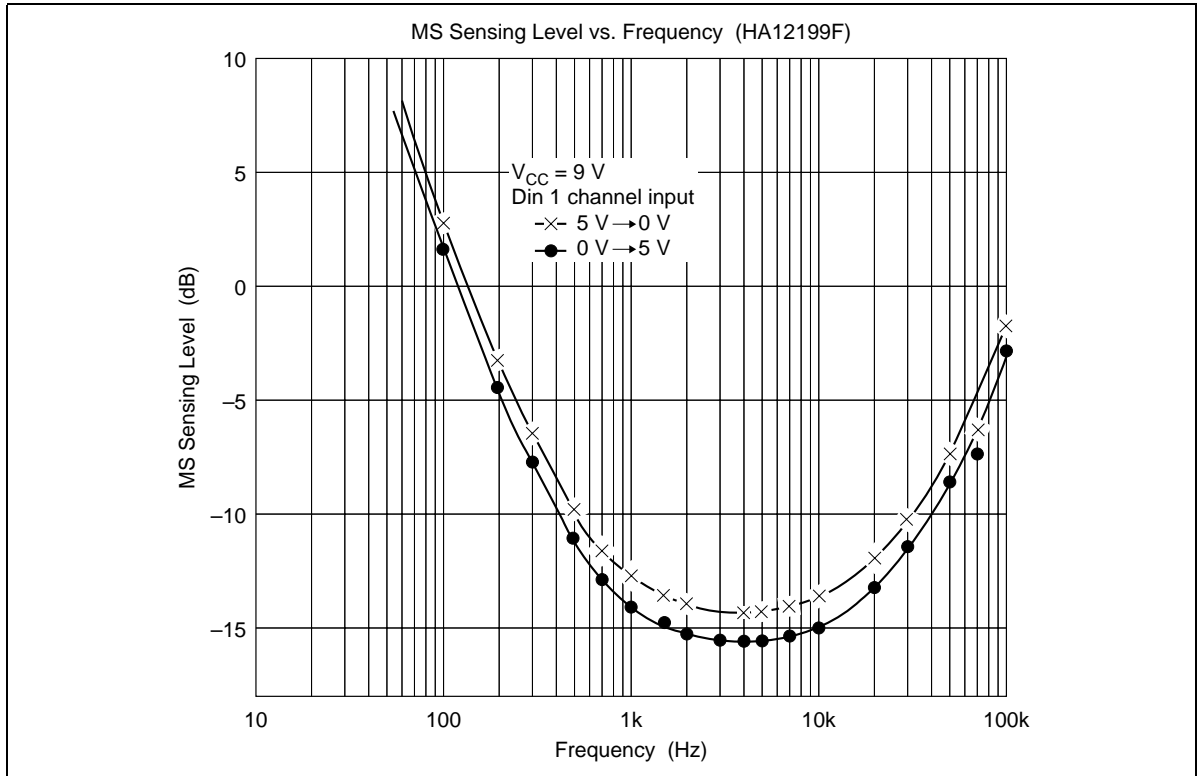

HA12192F/HA12197F/HA12212F Series

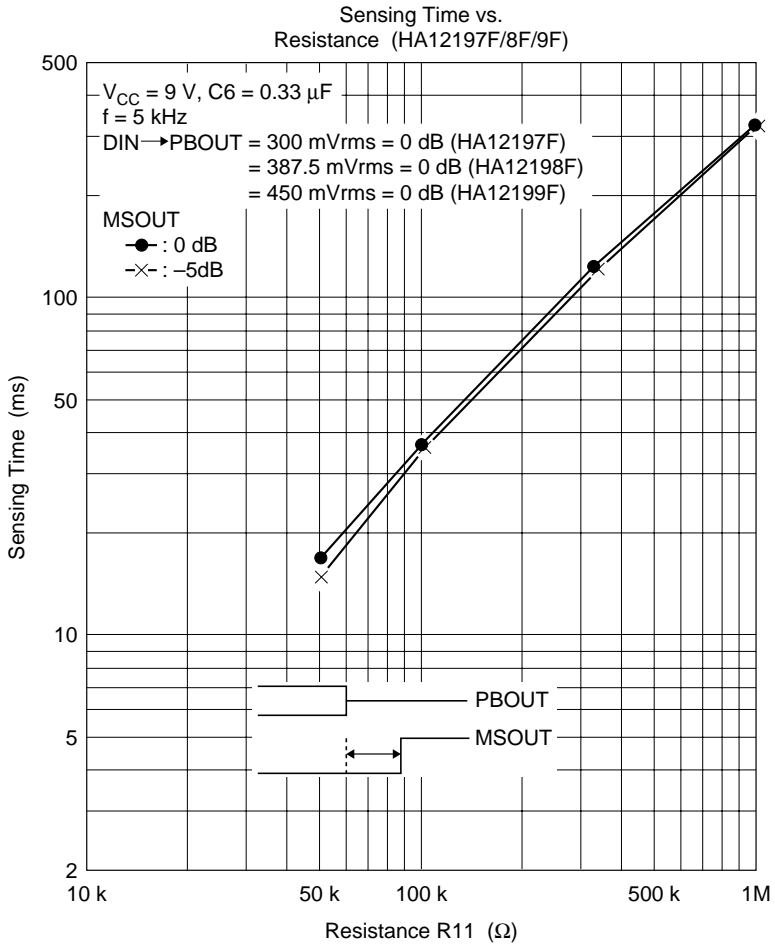

HA12192F/HA12197F/HA12212F Series

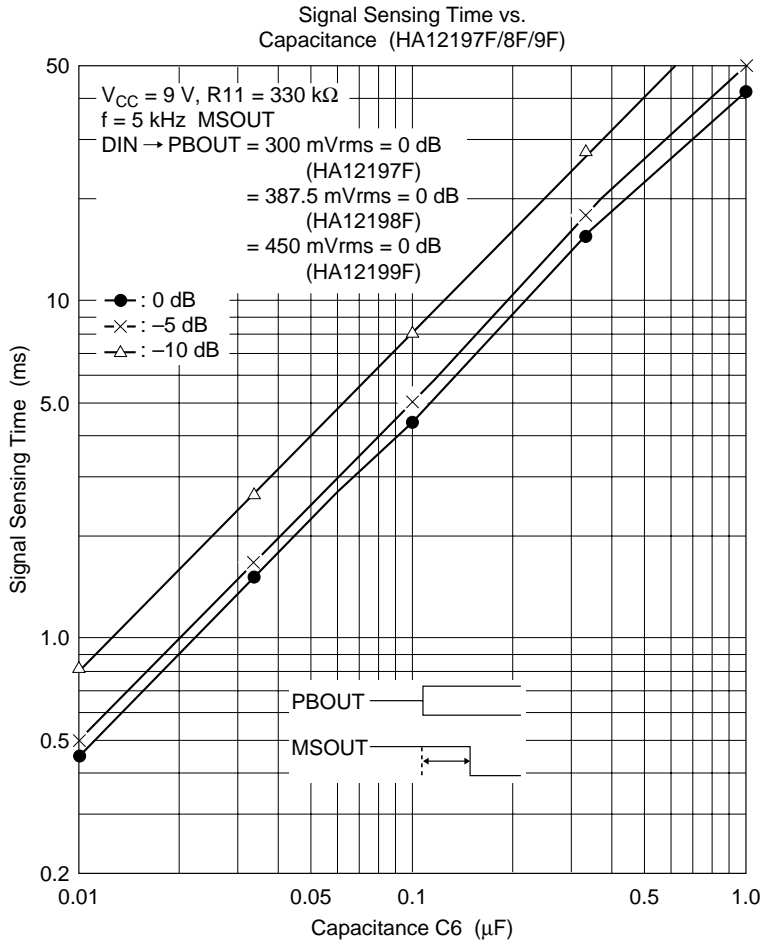

HA12192F/HA12197F/HA12212F Series

Package Dimensions

Unit: mm

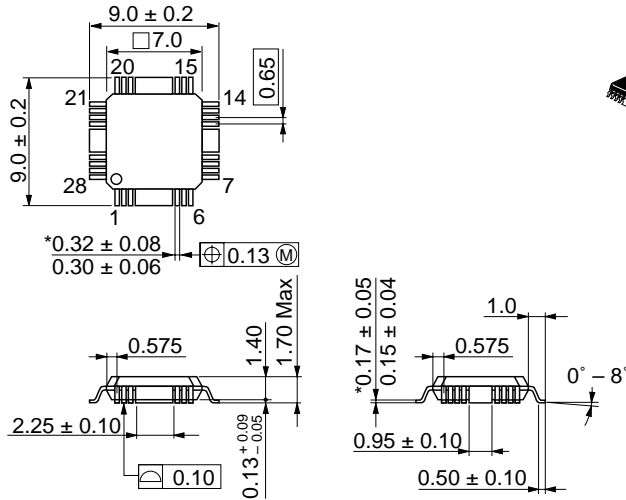

*Dimension including the plating thickness
Base material dimension

Hitachi Code	FP-28TB
JEDEC	—
EIAJ	—
Weight (reference value)	0.2 g

Unit: mm

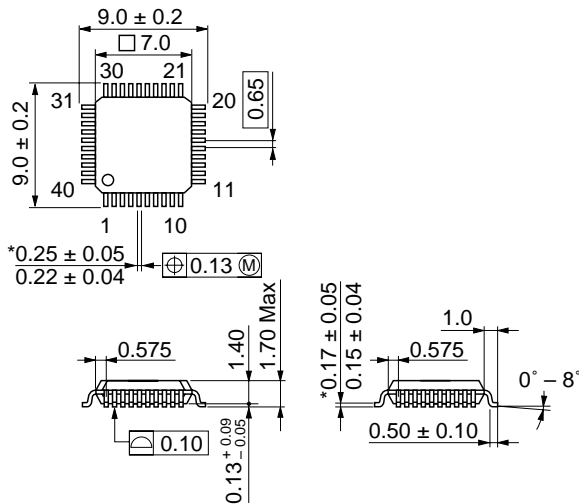

*Dimension including the plating thickness
Base material dimension

Hitachi Code	FP-40B
JEDEC	—
EIAJ	Conforms
Weight (reference value)	0.2 g

Disclaimer

1. Hitachi neither warrants nor grants licenses of any rights of Hitachi's or any third party's patent, copyright, trademark, or other intellectual property rights for information contained in this document. Hitachi bears no responsibility for problems that may arise with third party's rights, including intellectual property rights, in connection with use of the information contained in this document.
2. Products and product specifications may be subject to change without notice. Confirm that you have received the latest product standards or specifications before final design, purchase or use.
3. Hitachi makes every attempt to ensure that its products are of high quality and reliability. However, contact Hitachi's sales office before using the product in an application that demands especially high quality and reliability or where its failure or malfunction may directly threaten human life or cause risk of bodily injury, such as aerospace, aeronautics, nuclear power, combustion control, transportation, traffic, safety equipment or medical equipment for life support.
4. Design your application so that the product is used within the ranges guaranteed by Hitachi particularly for maximum rating, operating supply voltage range, heat radiation characteristics, installation conditions and other characteristics. Hitachi bears no responsibility for failure or damage when used beyond the guaranteed ranges. Even within the guaranteed ranges, consider normally foreseeable failure rates or failure modes in semiconductor devices and employ systemic measures such as fail-safes, so that the equipment incorporating Hitachi product does not cause bodily injury, fire or other consequential damage due to operation of the Hitachi product.
5. This product is not designed to be radiation resistant.
6. No one is permitted to reproduce or duplicate, in any form, the whole or part of this document without written approval from Hitachi.
7. Contact Hitachi's sales office for any questions regarding this document or Hitachi semiconductor products.

Sales Offices

HITACHI

Hitachi, Ltd.

Semiconductor & Integrated Circuits.

Nippon Bldg., 2-6-2, Ohte-machi, Chiyoda-ku, Tokyo 100-0004, Japan
Tel: Tokyo (03) 3270-2111 Fax: (03) 3270-5109

URL NorthAmerica : <http://semiconductor.hitachi.com/>
 Europe : <http://www.hitachi-eu.com/hel/ecg>
 Asia : <http://sicapac.hitachi-asia.com>
 Japan : <http://www.hitachi.co.jp/Sicd/indx.htm>

For further information write to:

Hitachi Semiconductor
(America) Inc.
179 East Tasman Drive,
San Jose, CA 95134
Tel: <1>(408) 433-1990
Fax: <1>(408) 433-0223

Hitachi Europe GmbH
Electronic Components Group
Dornacher Straße 3
D-85622 Feldkirchen, Munich
Germany
Tel: <49> (89) 9 9180-0
Fax: <49> (89) 9 29 30 00

Hitachi Europe Ltd.
Electronic Components Group.
Whitebrook Park
Lower Cookham Road
Maidenhead
Berkshire SL6 8YA, United Kingdom
Tel: <44> (1628) 585000
Fax: <44> (1628) 585160

Hitachi Asia Ltd.
Hitachi Tower
16 Collyer Quay #20-00,
Singapore 049318
Tel : <65>-538-6533/538-8577
Fax : <65>-538-6933/538-3877
URL : <http://www.hitachi.com.sg>

Hitachi Asia Ltd.
(Taipei Branch Office)
4/F, No. 167, Tun Hwa North Road,
Hung-Kuo Building,
Taipei (105), Taiwan
Tel : <886>-(2)-2718-3666
Fax : <886>-(2)-2718-8180
Telex : 23222 HAS-TP
URL : <http://www.hitachi.com.tw>

Hitachi Asia (Hong Kong) Ltd.
Group III (Electronic Components)
7/F., North Tower,
World Finance Centre,
Harbour City, Canton Road
Tsim Sha Tsui, Kowloon,
Hong Kong
Tel : <852>-(2)-735-9218
Fax : <852>-(2)-730-0281
URL : <http://www.hitachi.com.hk>

Copyright © Hitachi, Ltd., 2000. All rights reserved. Printed in Japan.
Colophon 2.0