

**H11AV1-M**

**H11AV1A-M**

**H11AV2-M**

**H11AV2A-M**

**PACKAGE OUTLINE**

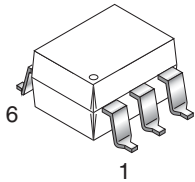

H11AV1S-M, H11AV2S-M

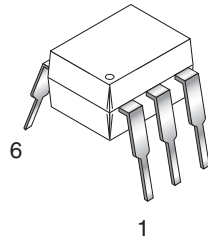

H11AV1-M, H11AV2-M

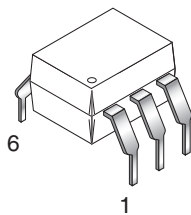

H11AV1A-M, H11AV2A-M

**SCHEMATIC**

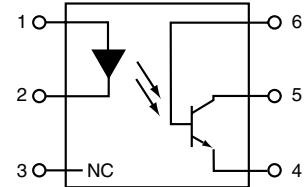

- PIN 1. ANODE
- 2. CATHODE
- 3. NO CONNECTION
- 4. EMITTER
- 5. COLLECTOR
- 6. BASE

**DESCRIPTION**

The general purpose optocouplers consist of a gallium arsenide infrared emitting diode driving a silicon phototransistor in a 6-pin dual in-line white package.

**FEATURES**

- H11AV1 and H11AV2 feature 0.3" input-output lead spacing
- H11AV1A and H11AV2A feature 0.4" input-output lead spacing
- UL recognized (File #E90700, Vol. 2)
- VDE recognized (File #102497)
- Add option V (e.g., H11AV1AV-M)

**APPLICATIONS**

- Power supply regulators
- Digital logic inputs
- Microprocessor inputs

**H11AV1-M**

**H11AV1A-M**

**H11AV2-M**

**H11AV2A-M**

**ABSOLUTE MAXIMUM RATINGS** ( $T_A = 25^\circ\text{C}$  unless otherwise specified)

| Parameter   | Symbol    | Value          | Units                |
|---|-----------|----------------|----------------------|
| <b>TOTAL DEVICE</b>   |           |                |                      |
| Storage Temperature   | $T_{STG}$ | -40 to +150    | $^\circ\text{C}$     |
| Operating Temperature   | $T_{OPR}$ | -40 to +100    | $^\circ\text{C}$     |
| Wave solder temperature (see page 9 for reflow solder profiles) | $T_{SOL}$ | 260 for 10 sec | $^\circ\text{C}$     |
| Total Device Power Dissipation @ $T_A = 25^\circ\text{C}$       | $P_D$     | 250            | mW                   |
| Derate above $25^\circ\text{C}$                                 |           | 2.94           | mW/ $^\circ\text{C}$ |
| <b>EMITTER</b>  |           |                |                      |
| DC/Average Forward Input Current                                | $I_F$     | 60             | mA                   |
| Reverse Input Voltage   | $V_R$     | 6              | V                    |
| LED Power Dissipation @ $T_A = 25^\circ\text{C}$                | $P_D$     | 120            | mW                   |
| Derate above $25^\circ\text{C}$                                 |           | 1.41           | mW/ $^\circ\text{C}$ |
| <b>DETECTOR</b>   |           |                |                      |
| Collector-Emitter Voltage                                       | $V_{CEO}$ | 70             | V                    |
| Collector-Base Voltage  | $V_{CBO}$ | 70             | V                    |
| Emitter-Collector Voltage                                       | $V_{ECO}$ | 7              | V                    |
| Detector Power Dissipation @ $T_A = 25^\circ\text{C}$           | $P_D$     | 150            | mW                   |
| Derate above $25^\circ\text{C}$                                 |           | 1.76           | mW/ $^\circ\text{C}$ |

**H11AV1-M**

**H11AV1A-M**

**H11AV2-M**

**H11AV2A-M**

**ELECTRICAL CHARACTERISTICS** ( $T_A = 25^\circ\text{C}$  unless otherwise specified)

**INDIVIDUAL COMPONENT CHARACTERISTICS**

| Parameter                                      | Test Conditions                                | Symbol     | Min | Typ* | Max | Unit          |
|--|--|------------|-----|------|-----|---------------|
| <b>EMITTER</b>                                 |  |            |     |      |     |               |
| Input Forward Voltage ( $I_F = 10\text{ mA}$ ) | $T_A = 25^\circ\text{C}$                       | $V_F$      | 0.8 | 1.18 | 1.5 | V             |
|  | $T_A = -55^\circ\text{C}$                      |            | 0.9 | 1.28 | 1.7 |               |
|  | $T_A = 100^\circ\text{C}$                      |            | 0.7 | 1.05 | 1.4 |               |
| Reverse Leakage Current                        | ( $V_R = 6.0\text{ V}$ )                       | $I_R$      |     |      | 10  | $\mu\text{A}$ |
| <b>DETECTOR</b>                                |  |            |     |      |     |               |
| Collector-Emitter Breakdown Voltage            | ( $I_C = 1.0\text{ mA}$ , $I_F = 0$ )          | $BV_{CEO}$ | 70  | 100  |     | V             |
| Collector-Base Breakdown Voltage               | ( $I_C = 100\ \mu\text{A}$ , $I_F = 0$ )       | $BV_{CBO}$ | 70  | 120  |     | V             |
| Emitter-Collector Breakdown Voltage            | ( $I_E = 100\ \mu\text{A}$ , $I_F = 0$ )       | $BV_{ECO}$ | 7   | 10   |     | V             |
| Collector-Emitter Dark Current                 | ( $V_{CE} = 10\text{ V}$ , $I_F = 0$ )         | $I_{CEO}$  |     | 1    | 50  | nA            |
| Collector-Base Dark Current                    | ( $V_{CB} = 10\text{ V}$ )                     | $I_{CBO}$  |     | 0.5  |     | nA            |
| Capacitance                                    | ( $V_{CE} = 0\text{ V}$ , $f = 1\text{ MHz}$ ) | $C_{CE}$   |     | 8    |     | pF            |

**ISOLATION CHARACTERISTICS**

| Characteristic                 | Test Conditions                                 | Symbol    | Min       | Typ* | Max | Units    |
|--------------------------------|---|-----------|-----------|------|-----|----------|
| Input-Output Isolation Voltage | ( $f = 60\text{ Hz}$ , $t = 1\text{ sec}$ )     | $V_{ISO}$ | 7500      |      |     | Vac(pk)  |
| Isolation Resistance           | ( $V_{I-O} = 500\text{ VDC}$ )                  | $R_{ISO}$ | $10^{11}$ |      |     | $\Omega$ |
| Isolation Capacitance          | ( $V_{I-O} = 0\text{ V}$ , $f = 1\text{ MHz}$ ) | $C_{ISO}$ |           | 0.2  | 2   | pF       |

Note

\* Typical values at  $T_A = 25^\circ\text{C}$

**H11AV1-M**

**H11AV1A-M**

**H11AV2-M**

**H11AV2A-M**

**TRANSFER CHARACTERISTICS** ( $T_A = 25^\circ\text{C}$  Unless otherwise specified.)

| DC Characteristic                            | Test Conditions   | Symbol        | Device            | Min | Typ* | Max | Unit          |
|--|---|---------------|-------------------|-----|------|-----|---------------|
| Current Transfer Ratio, Collector to Emitter | $(I_F = 10 \text{ mA}, V_{CE} = 10 \text{ V})$                              | CTR           | H11AV1<br>H11AV1A | 100 |      | 300 | %             |
|  |   |               | H11AV2<br>H11AV2A | 50  |      |     |               |
| Collector-Emitter Saturation Voltage         | $(I_C = 2 \text{ mA}, I_F = 20 \text{ mA})$                                 | $V_{CE(SAT)}$ | All               |     |      | 0.4 | V             |
| <b>AC Characteristic</b>                     |   |               |                   |     |      |     |               |
| Non-Saturated Turn-on Time                   | $(I_C = 2 \text{ mA}, V_{CC} = 10 \text{ V}, R_L = 100\Omega)$<br>(Fig. 11) | $T_{ON}$      | All               |     |      | 15  | $\mu\text{s}$ |
| Non Saturated Turn-off Time                  |   |               |                   |     |      | 15  | $\mu\text{s}$ |

\* Typical values at  $T_A = 25^\circ\text{C}$

**TYPICAL PERFORMANCE CURVES**

**Fig. 1 LED Forward Voltage vs. Forward Current**

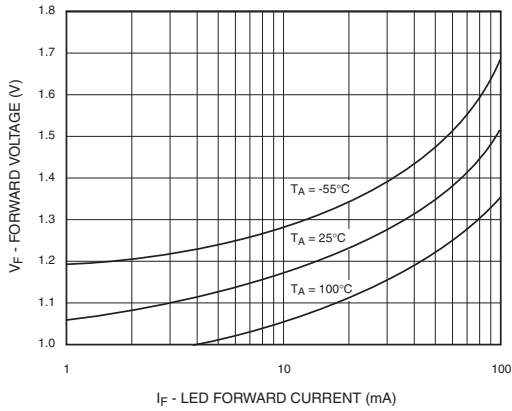

**Fig. 2 Normalized CTR vs. Forward Current**

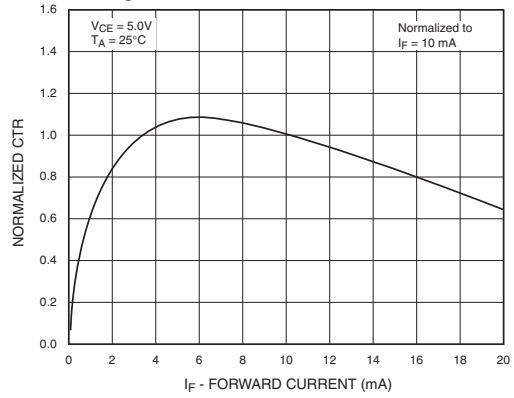

**Fig. 3 Normalized CTR vs. Ambient Temperature**

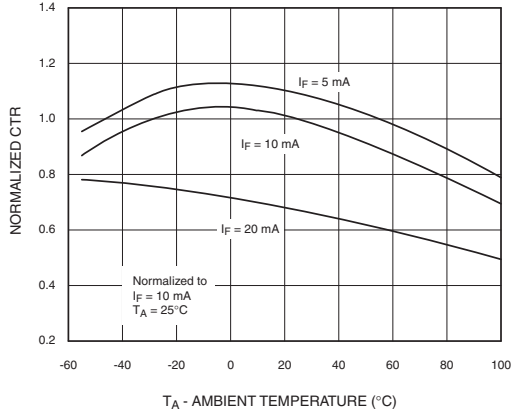

**Fig. 4 CTR vs. RBE (Unsaturated)**

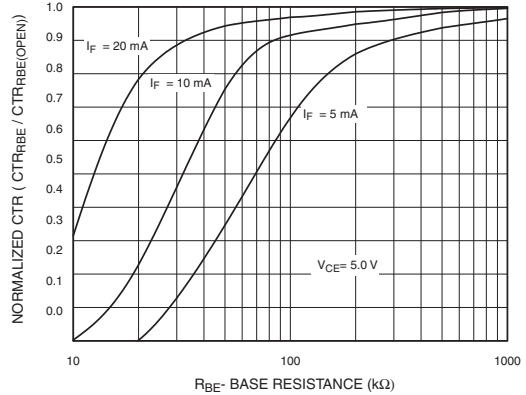

**Fig. 5 CTR vs. RBE (Saturated)**

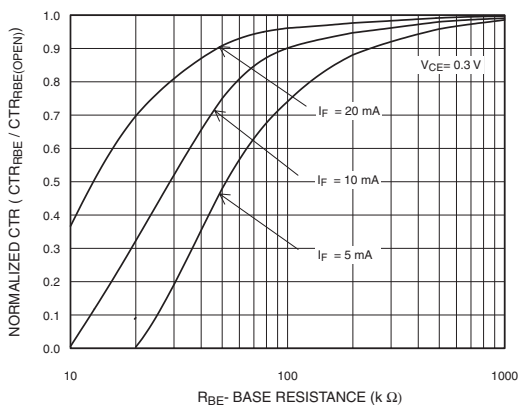

**Fig. 6 Collector-Emitter Saturation Voltage vs. Collector Current**

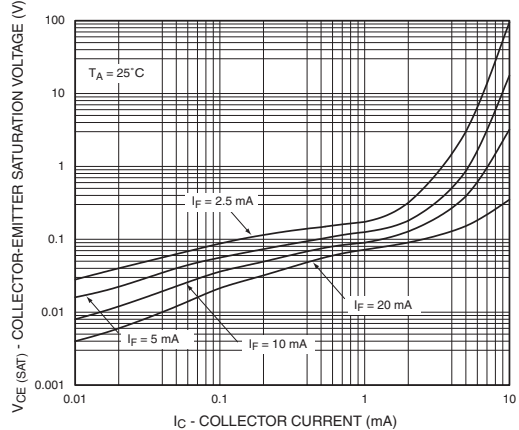

**H11AV1-M**

**H11AV1A-M**

**H11AV2-M**

**H11AV2A-M**

**Fig. 7 Switching Speed vs. Load Resistor**

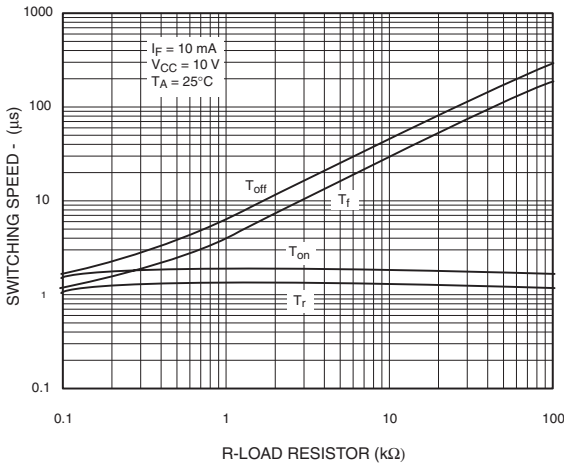

**Fig. 8 Normalized  $t_{on}$  vs.  $R_{BE}$**

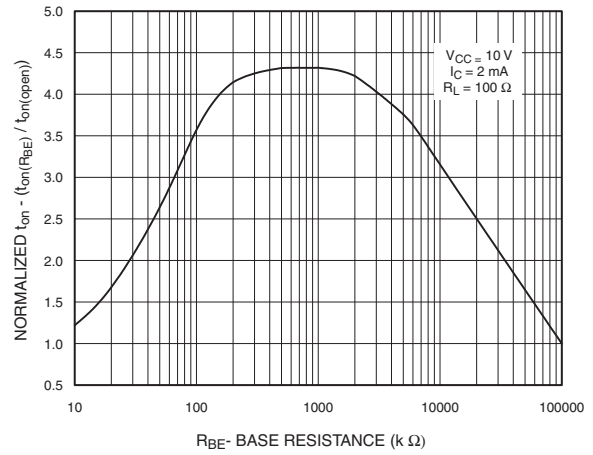

**Fig. 9 Normalized  $t_{off}$  vs.  $R_{BE}$**

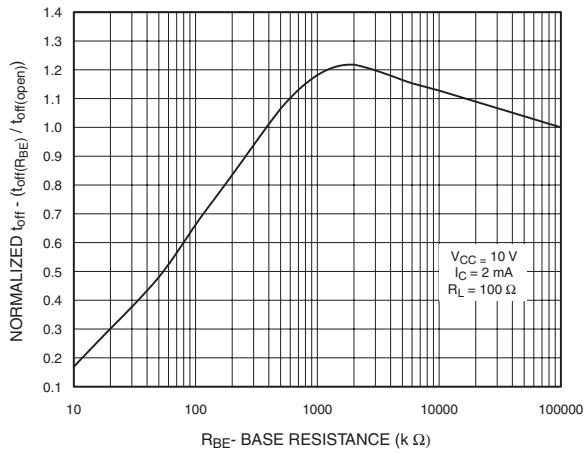

**Fig. 10 Dark Current vs. Ambient Temperature**

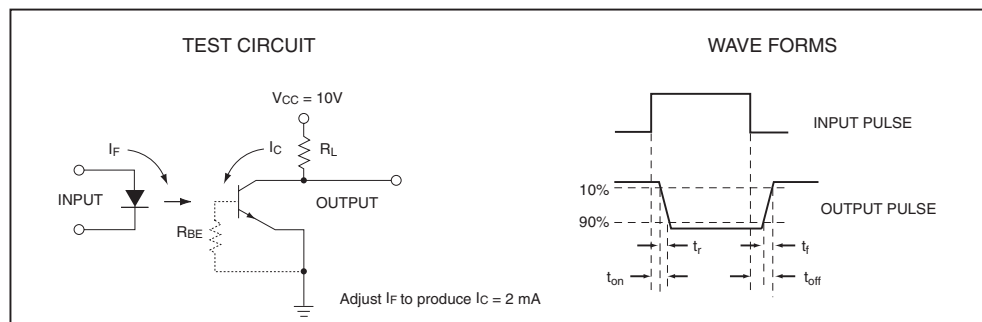
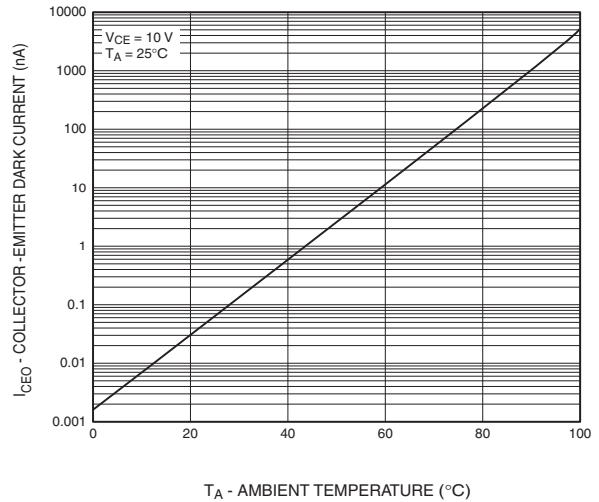

**Figure 11. Switching Time Test Circuit and Waveforms**

**H11AV1-M**

**H11AV1A-M**

**H11AV2-M**

**H11AV2A-M**

**Package Dimensions (Through Hole)**

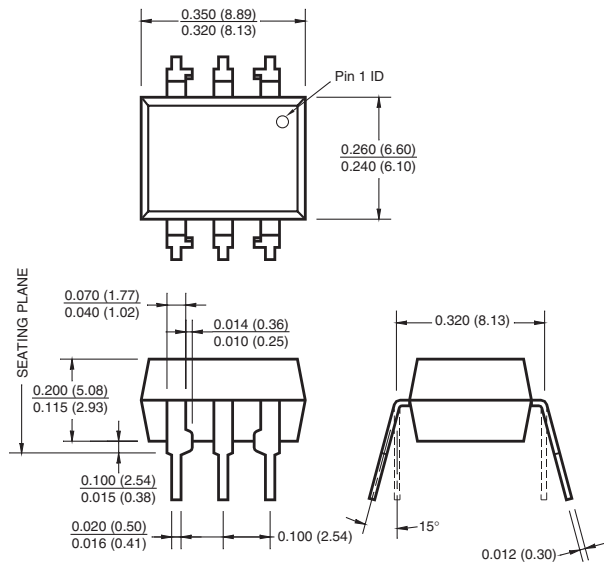

**Package Dimensions (Surface Mount)**

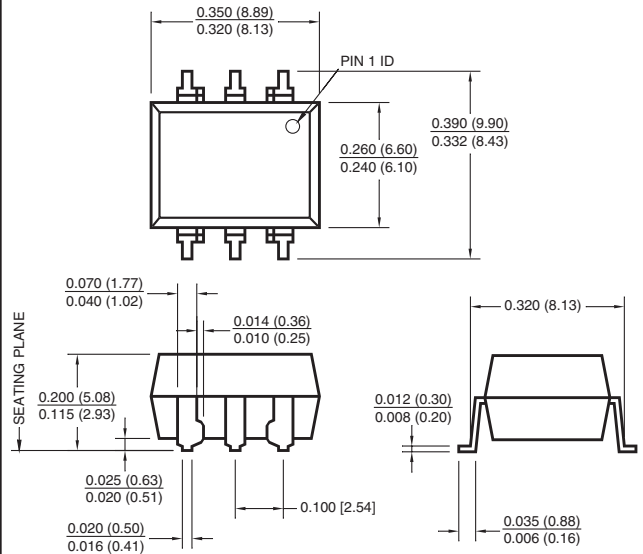

**Package Dimensions (0.4" Lead Spacing)**

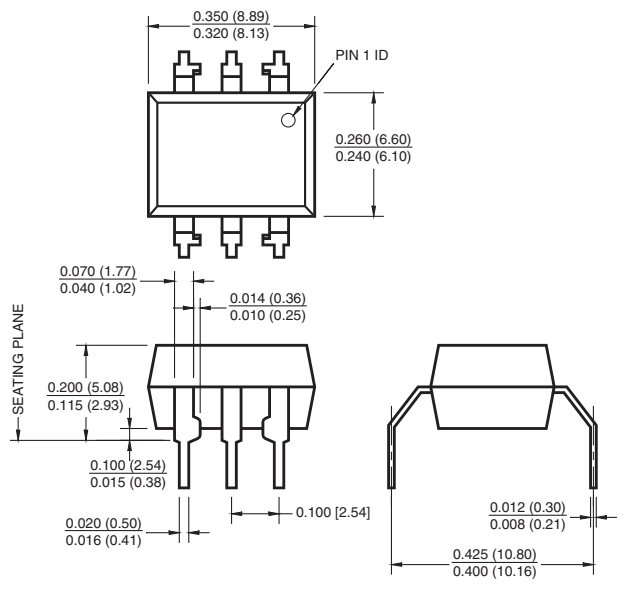

**Recommended Pad Layout for Surface Mount Leadform**

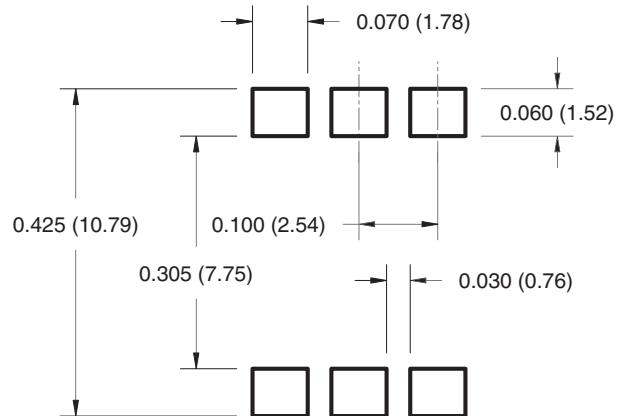

**NOTE**

All dimensions are in inches (millimeters)

**H11AV1-M**

**H11AV1A-M**

**H11AV2-M**

**H11AV2A-M**

**ORDERING INFORMATION**

| Order Entry Identifier |                                      |              |
|------------------------|--------------------------------------|--------------|
| Order Entry Identifier | Option                               | Example      |
| S                      | Surface Mount Lead Bend              | H11AV1S-M    |
| SR2                    | Surface Mount; Tape and reel         | H11AV1SR2-M  |
| N/A                    | 0.4" Lead Spacing                    | H11AV1A-M    |
| V                      | VDE 0884                             | H11AV1V-M    |
| N/A                    | VDE 0884, 0.4" Lead Spacing          | H11AV1AV-M   |
| SV                     | VDE 0884, Surface Mount              | H11AV1SV-M   |
| SR2V                   | VDE 0884, Surface Mount, Tape & Reel | H11AV1SR2V-M |

**MARKING INFORMATION**

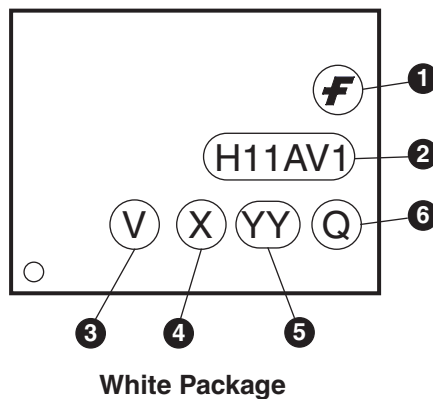

| Definitions |  |
|-------------|--|
| 1           | Fairchild logo   |
| 2           | Device number  |
| 3           | VDE mark (Note: Only appears on parts ordered with VDE option – See order entry table) |
| 4           | One digit year code<br>• One digit for white package parts, e.g., '3'                  |
| 5           | Two digit work week ranging from '01' to '53'  |
| 6           | Assembly package code  |

\*Note – Parts built in the white package (M suffix) that do not have the 'V' option (see definition 3 above) that are marked with date code '325' or earlier are marked in the portrait format.



**H11AV1-M**

**H11AV1A-M**

**H11AV2-M**

**H11AV2A-M**

**Carrier Tape Specifications**

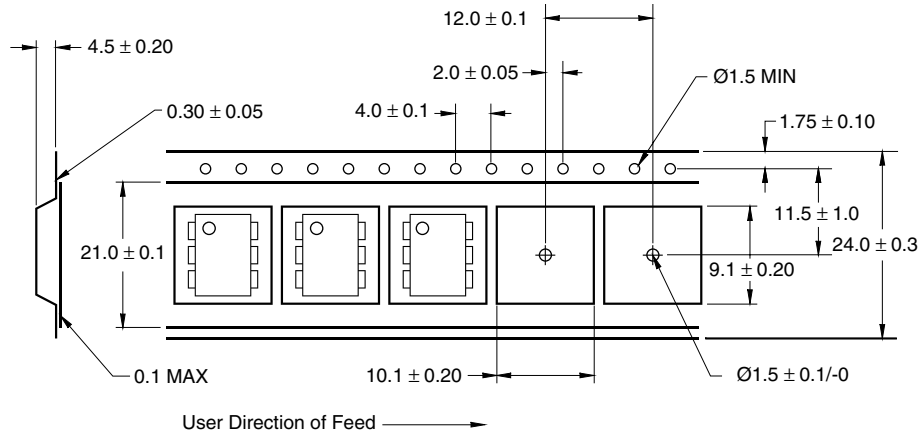

**Reflow Profile**

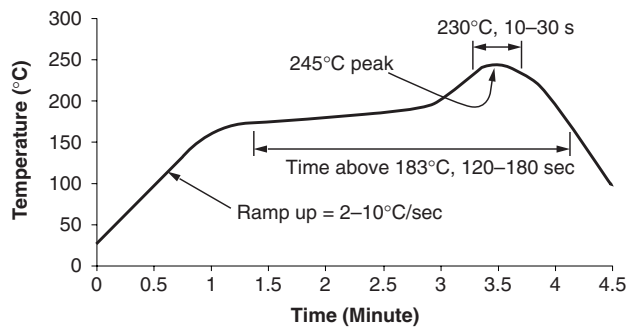

- Peak reflow temperature: 245°C (package surface temperature)
- Time of temperature higher than 183°C for 120–180 seconds
- One time soldering reflow is recommended

---

**H11AV1-M**

**H11AV1A-M**

**H11AV2-M**

**H11AV2A-M**

---

**DISCLAIMER**

FAIRCHILD SEMICONDUCTOR RESERVES THE RIGHT TO MAKE CHANGES WITHOUT FURTHER NOTICE TO ANY PRODUCTS HEREIN TO IMPROVE RELIABILITY, FUNCTION OR DESIGN. FAIRCHILD DOES NOT ASSUME ANY LIABILITY ARISING OUT OF THE APPLICATION OR USE OF ANY PRODUCT OR CIRCUIT DESCRIBED HEREIN; NEITHER DOES IT CONVEY ANY LICENSE UNDER ITS PATENT RIGHTS, NOR THE RIGHTS OF OTHERS.

**LIFE SUPPORT POLICY**

FAIRCHILD'S PRODUCTS ARE NOT AUTHORIZED FOR USE AS CRITICAL COMPONENTS IN LIFE SUPPORT DEVICES OR SYSTEMS WITHOUT THE EXPRESS WRITTEN APPROVAL OF THE PRESIDENT OF FAIRCHILD SEMICONDUCTOR CORPORATION. As used herein:

1. Life support devices or systems are devices or systems which, (a) are intended for surgical implant into the body, or (b) support or sustain life, and (c) whose failure to perform when properly used in accordance with instructions for use provided in the labeling, can be reasonably expected to result in a significant injury of the user.
2. A critical component in any component of a life support device or system whose failure to perform can be reasonably expected to cause the failure of the life support device or system, or to affect its safety or effectiveness.