

CD40194B Types

CMOS 4-Bit Bidirectional Universal Shift Register

High-Voltage Types (20 Volt Rating)

■ CD40194B is a universal shift register featuring parallel inputs, parallel outputs SHIFT RIGHT and SHIFT LEFT serial inputs, and a direct overriding clear input. In the parallel-load mode (S0 and S1 are high), data is loaded into the associated flip-flop and appears at the output after the positive transition of the CLOCK input. During loading, serial data flow is inhibited. Shift right and shift left are accomplished synchronously on the positive clock edge with data entered at the SHIFT RIGHT and SHIFT LEFT serial inputs, respectively. Clocking of the register is inhibited when both mode control inputs are low. When low, the RESET input resets all stages and forces all outputs low.

The CD40194B types are supplied in 16-lead dual-in-line plastic packages (E suffix), 16-lead small-outline packages (NSR suffix), and 16-lead thin shrink small-outline packages (PW and PWR suffixes).

MAXIMUM RATINGS, Absolute-Maximum Values:

DC SUPPLY-VOLTAGE RANGE, (V_{DD})	
Voltages referenced to V _{SS} Terminal	-0.5V to +20V
INPUT VOLTAGE RANGE, ALL INPUTS	-0.5V to V _{DD} +0.5V
DC INPUT CURRENT, ANY ONE INPUT	±10mA
POWER DISSIPATION PER PACKAGE (P_D):	
For T _A = -55°C to +100°C	500mW
For T _A = +100°C to +125°C	Derate Linearity at 12mW/°C to 200mW
DEVICE DISSIPATION PER OUTPUT TRANSISTOR	
FOR T _A = FULL PACKAGE-TEMPERATURE RANGE (All Package Types)	100mW
OPERATING-TEMPERATURE RANGE (T _A)	-55°C to +125°C
STORAGE TEMPERATURE RANGE (T _{stg})	-65°C to +150°C
LEAD TEMPERATURE (DURING SOLDERING):	
At distance 1/16 ± 1/32 inch (1.59 ± 0.79mm) from case for 10s max	+265°C

NOT RECOMMENDED FOR NEW DESIGNS

Features:

- Medium-speed: f_{CL} = 12 MHz (typ.) @ V_{DD} = 10 V
- Fully static operation
- Synchronous parallel or serial operation
- Asynchronous master reset
- Standardized, symmetrical output characteristics
- 5-V, 10-V, and 15-V parametric ratings
- Meets all requirements of JEDEC Tentative Standard No. 13B, "Standard Specifications for Description of 'B' Series CMOS Devices"

Applications:

- Arithmetic unit bus registers
- Serial/parallel conversions
- General-purpose register for bus-organized systems
- General-purpose registers

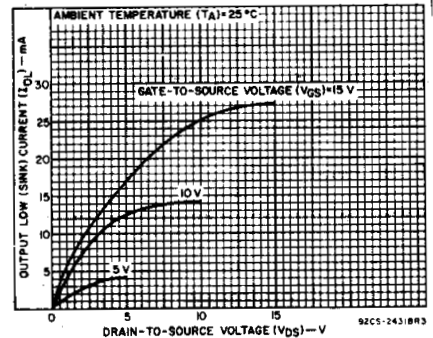
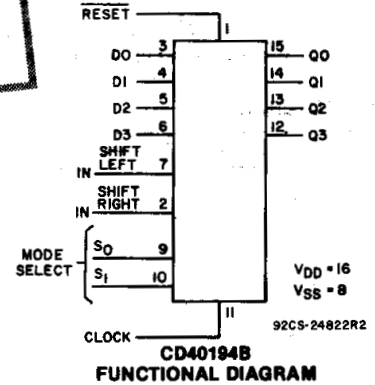

Fig. 1—Typical n-channel output low (sink) current characteristics.

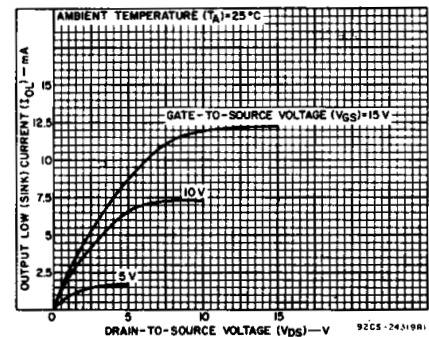

Fig. 2—Minimum n-channel output low (sink) current characteristics.

3
COMMERCIAL CMOS HIGH VOLTAGE ICs

CD40194B Types

RECOMMENDED OPERATING CONDITIONS at $T_A = 25^\circ\text{C}$, Except as Noted.
 For maximum reliability, nominal operating conditions should be selected so that operation is always within the following ranges:

CHARACTERISTIC	VDD (V)	LIMITS		UNITS
		Min.	Max.	
Supply-Voltage Range (For Package-Temperature Range)		3	18	V
Setup Time, D0, D3, SR _{IN} , SL _{IN} to clock SELECT 0, SELECT 1 to clock	5	100	—	ns
	10	70	—	
	15	50	—	
Hold Time, D0, D3, SR _{IN} , SL _{IN} to clock SELECT 0, SELECT 1 to clock	5	0	—	ns
	10	0	—	
	15	0	—	
Clock Pulse Width, Clock Input Frequency	5	180	—	MHz
	10	80	—	
	15	50	—	
Clock Input Rise or Fall Time, Reset Pulse Width,	5	1000	—	μs
	10	100	—	
	15	100	—	
Clock Input Rise or Fall Time, Reset Pulse Width,	5	300	—	ns
	10	200	—	
	15	140	—	

CONTROL TRUTH TABLE FOR CD40194B SERIES

CLOCK	MODE SELECT		RESET	ACTION
	S ₀	S ₁		
X	0	0	1	No Change
	1	0	1	Shift Right (Q0 toward Q3)
	0	1	1	Shift Left (Q3 toward Q0)
	1	1	1	Parallel Load
X	X	X	0	Reset

1 = High level
 0 = Low level

X = Don't care
 ▲ = Level change

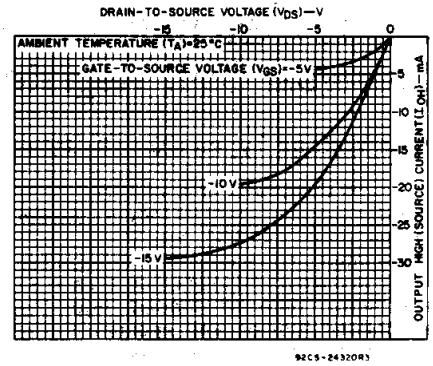

Fig. 3—Typical p-channel output high (source) current characteristics.

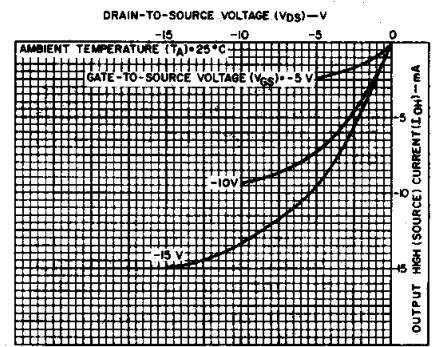

Fig. 4—Minimum p-channel output high (source) current characteristics.

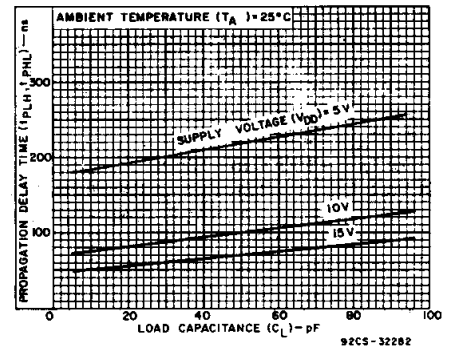

Fig. 5—Typical propagation delay time as a function of load capacitance, (CLOCK to Q).

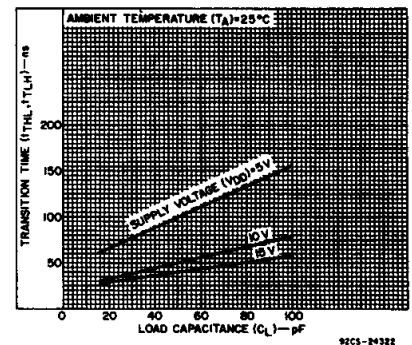

Fig. 6—Typical transition time as a function of load capacitance.

CD40194B Types

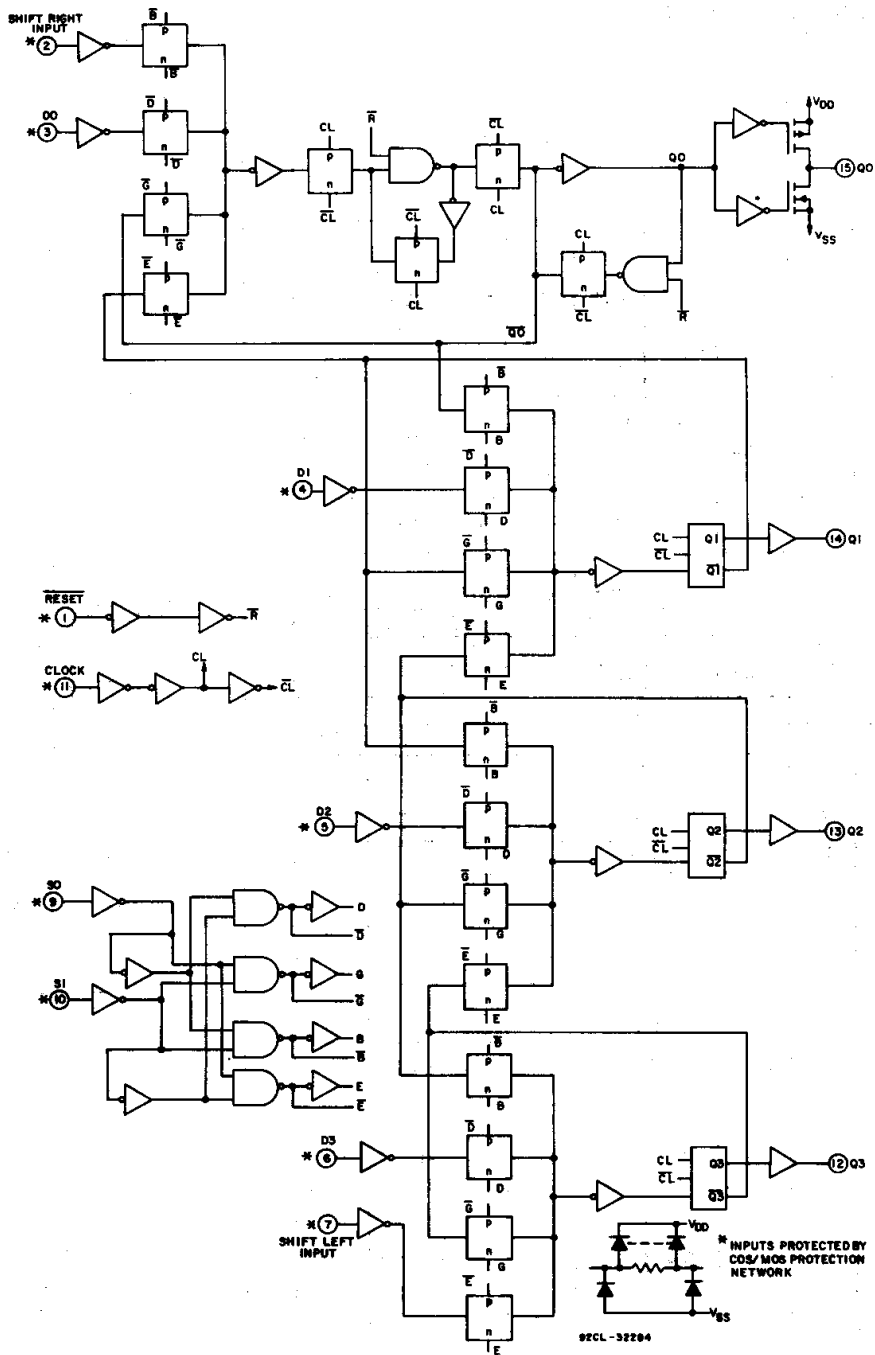

Fig. 8—CD40194B logic diagram.

COMMERCIAL CMOS
HIGH VOLTAGE ICs

CD40194B Types

STATIC ELECTRICAL CHARACTERISTICS

CHARACTERISTIC	CONDITIONS			LIMITS AT INDICATED TEMPERATURES (°C)							UNITS
	V _O (V)	V _{IN} (V)	V _{DD} (V)	-55	-40	+85	+125	+25			
								Min.	Typ.	Max.	
Quiescent Device Current, I _{DD} Max.	—	0,5	5	5	5	150	150	—	0.04	5	μA
	—	0,10	10	10	10	300	300	—	0.04	10	
	—	0,15	15	20	20	600	600	—	0.04	20	
Output Low (Sink) Current, I _{OL} Min.	0.4	0,5	5	0.64	0.61	0.42	0.36	0.51	1	—	mA
	0.5	0,10	10	1.8	1.5	1.1	0.9	1.3	2.6	—	
	1.5	0,15	15	4.2	4	2.8	2.4	3.4	6.8	—	
Output High (Source) Current, I _{OH} Min.	4.6	0,5	5	-0.64	-0.61	-0.42	-0.36	-0.51	-1	—	mA
	2.5	0,5	5	-2	-1.8	-1.3	-1.15	-1.6	-3.2	—	
	9.5	0,10	10	-1.6	-1.5	-1.1	-0.9	-1.3	-2.6	—	
	13.5	0,15	15	-4.2	-4	-2.8	-2.4	-3.4	-6.8	—	
Output Voltage: Low-Level, V _{OL} Max.	—	0,5	5	0.05			—	0	0.05	—	V
	—	0,10	10	0.05			—	0	0.05	—	
	—	0,15	15	0.05			—	0	0.05	—	
Output Voltage: High-Level, V _{OH} Min.	—	0,5	5	4.95			4.95	5	—	—	V
	—	0,10	10	9.95			9.95	10	—	—	
	—	0,15	15	14.95			14.95	15	—	—	
Input Low Voltage, V _{IL} Max.	0.5,4.5	—	5	1.5			—	—	1.5	—	V
	1,9	—	10	3			—	—	3	—	
	1.5,13.5	—	15	4			—	—	4	—	
Input High Voltage, V _{IH} Min.	0.5,4.5	—	5	3.5			3.5	—	—	—	V
	1,9	—	10	7			7	—	—	—	
	1.5,13.5	—	15	11			11	—	—	—	
Input Current I _{IN} Max.	—	0,18	18	±0.1	±0.1	±1	±1	—	±10 ⁻⁵	±0.1	μA
3-State Output Leakage Current, I _{OUT} Max.	0,18	0,18	18	±0.4	±0.4	±12	±12	—	±10 ⁻⁴	±0.4	μA

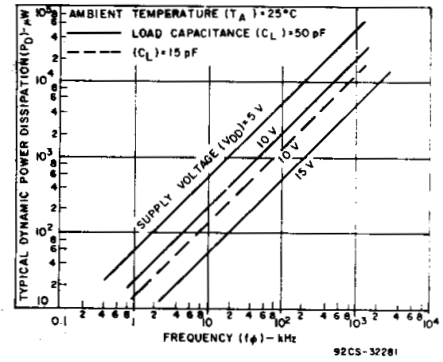

Fig. 9—Typical power dissipation as a function of frequency.

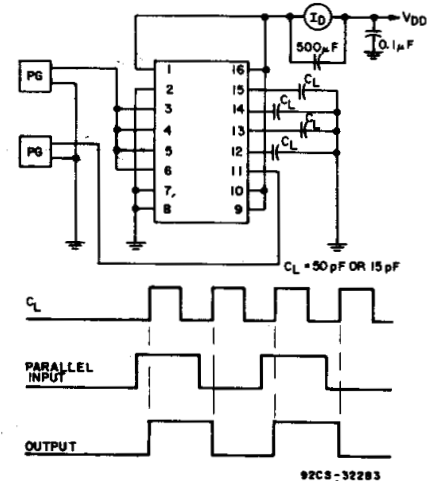

Fig. 10—Dynamic power dissipation test circuit.

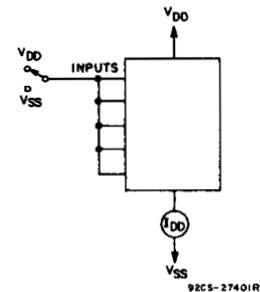

Fig. 11—Quiescent device current test circuit.

CD40194B Types

**DYNAMIC ELECTRICAL CHARACTERISTICS at $T_A = 25^\circ\text{C}$,
Input $t_r, t_f = 20\text{ ns}$, $C_L = 50\text{ pF}$, $R_L = 200\text{ k}\Omega$**

CHARACTERISTIC	TEST CONDITIONS	LIMITS			UNITS	
		VDD V	Min.	Typ.		Max.
Propagation Delay Time: Clock to Q t_{PHL}, t_{PLH}		5	—	220	440	ns
		10	—	100	200	
		15	—	70	140	
Output Transition Time t_{THL}, t_{TLH}		5	—	100	200	
		10	—	50	100	
		15	—	40	80	
Minimum Setup Time: t_s D0, D3, SR _{IN} , SL _{IN} to Clock		5	—	80	160	
		10	—	35	70	
		15	—	20	50	
SELECT 0, SELECT 1 to Clock		5	—	200	400	
		10	—	110	220	
		15	—	65	130	
Minimum Hold Time: t_H D0, D3, SR _{IN} , SL _{IN} to Clock		5	—	-65	0	
		10	—	-25	0	
		15	—	-15	0	
SELECT 0, SELECT 1 to Clock		5	—	-170	0	
		10	—	-95	0	
		15	—	-55	0	
Minimum Clock Pulse Width t_w		5	—	90	180	
		10	—	40	80	
		15	—	25	50	
Maximum Clock Input Frequency f_{CL}		5	3	6	—	MHz
		10	6	12	—	
		15	8	15	—	
Maximum Clock Rise or Fall Time t_{rCL}, t_{fCL}		5	—	—	1000	μs
		10	—	—	100	
		15	—	—	100	
Minimum Reset Pulse Width* t_{WR}		5	—	150	300	ns
		10	—	100	200	
		15	—	70	140	
Reset Propagation Delay t_{PRHL}		5	—	230	460	
		10	—	90	180	
		15	—	65	130	
Input Capacitance C_{IN}	Any Input	—	5	7.5	pF	

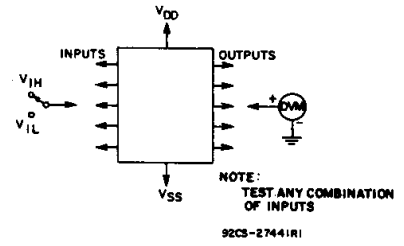

Fig. 12—Input-voltage test circuit.

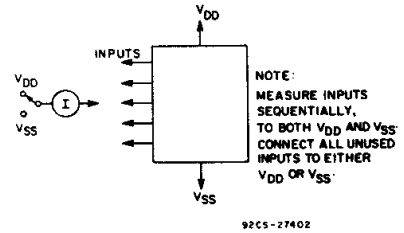
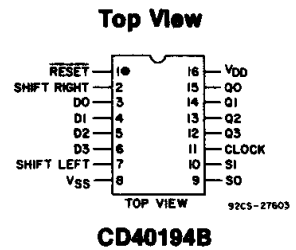

Fig. 13—Input current test circuit.

TERMINAL DIAGRAM



3
COMMERCIAL CMOS
HIGH VOLTAGE ICs

CD40194B Types

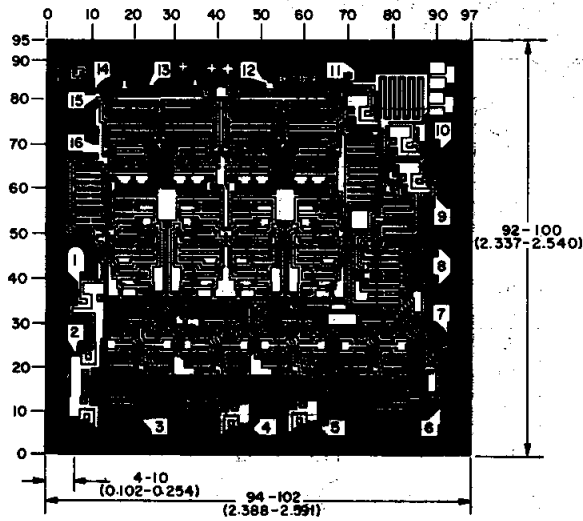

Dimensions and pad layout for CD40194BH

Dimensions in parentheses are in millimeters and are derived from the basic inch dimensions as indicated. Grid graduations are in mils (10^{-3} inch).

N (R-PDIP-T**)

PLASTIC DUAL-IN-LINE PACKAGE

16 PINS SHOWN

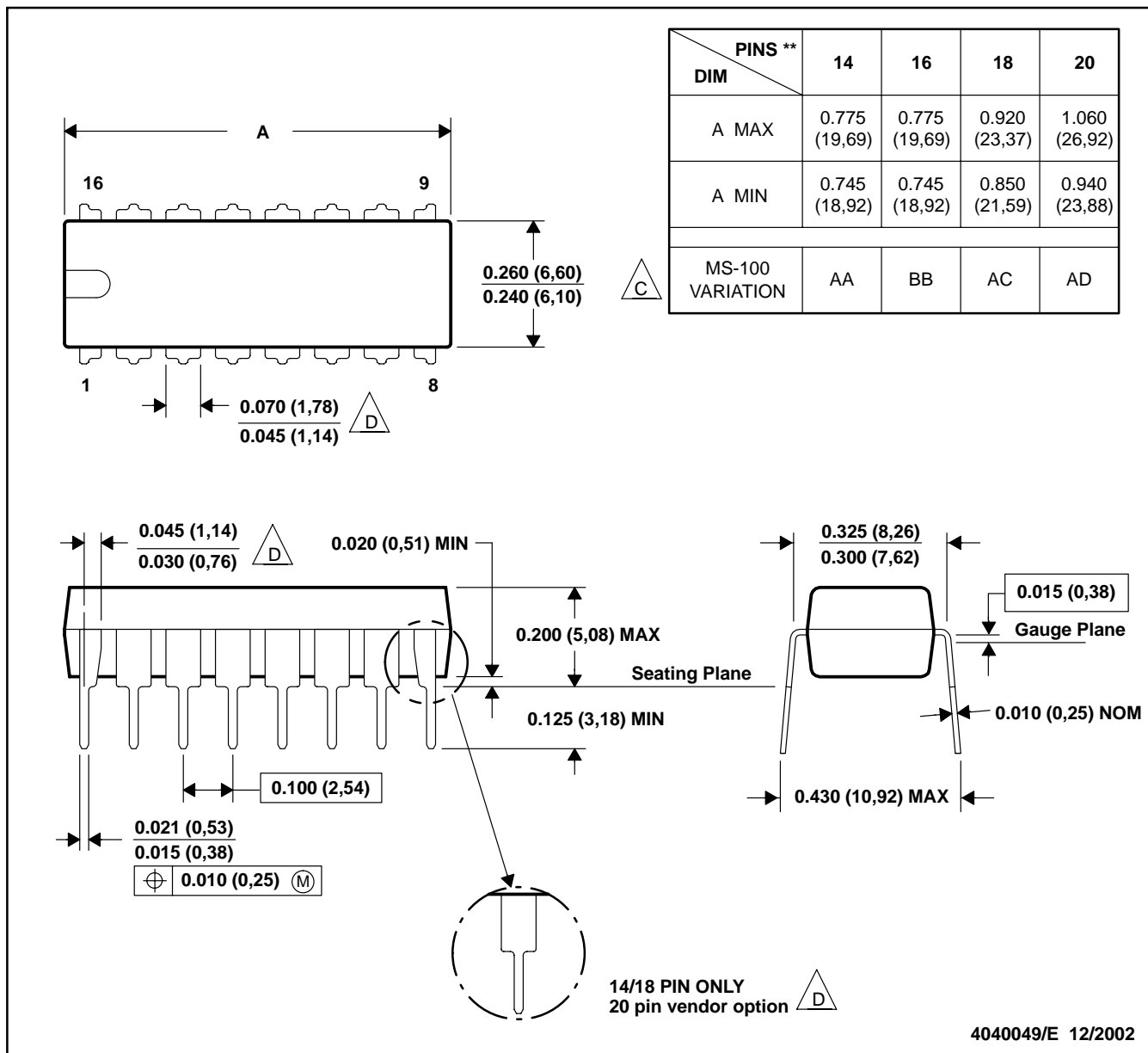

- NOTES: A. All linear dimensions are in inches (millimeters).
 B. This drawing is subject to change without notice.
 C Falls within JEDEC MS-001, except 18 and 20 pin minimum body length (Dim A).
 D The 20 pin end lead shoulder width is a vendor option, either half or full width.

MECHANICAL DATA

NS (R-PDSO-G)**

PLASTIC SMALL-OUTLINE PACKAGE

14-PINS SHOWN



- NOTES:
- All linear dimensions are in millimeters.
 - This drawing is subject to change without notice.
 - Body dimensions do not include mold flash or protrusion, not to exceed 0,15.

PW (R-PDSO-G**)

PLASTIC SMALL-OUTLINE PACKAGE

14 PINS SHOWN



4040064/F 01/97

- NOTES: A. All linear dimensions are in millimeters.
 B. This drawing is subject to change without notice.
 C. Body dimensions do not include mold flash or protrusion not to exceed 0,15.
 D. Falls within JEDEC MO-153

IMPORTANT NOTICE

Texas Instruments Incorporated and its subsidiaries (TI) reserve the right to make corrections, modifications, enhancements, improvements, and other changes to its products and services at any time and to discontinue any product or service without notice. Customers should obtain the latest relevant information before placing orders and should verify that such information is current and complete. All products are sold subject to TI's terms and conditions of sale supplied at the time of order acknowledgment.

TI warrants performance of its hardware products to the specifications applicable at the time of sale in accordance with TI's standard warranty. Testing and other quality control techniques are used to the extent TI deems necessary to support this warranty. Except where mandated by government requirements, testing of all parameters of each product is not necessarily performed.

TI assumes no liability for applications assistance or customer product design. Customers are responsible for their products and applications using TI components. To minimize the risks associated with customer products and applications, customers should provide adequate design and operating safeguards.

TI does not warrant or represent that any license, either express or implied, is granted under any TI patent right, copyright, mask work right, or other TI intellectual property right relating to any combination, machine, or process in which TI products or services are used. Information published by TI regarding third-party products or services does not constitute a license from TI to use such products or services or a warranty or endorsement thereof. Use of such information may require a license from a third party under the patents or other intellectual property of the third party, or a license from TI under the patents or other intellectual property of TI.

Reproduction of information in TI data books or data sheets is permissible only if reproduction is without alteration and is accompanied by all associated warranties, conditions, limitations, and notices. Reproduction of this information with alteration is an unfair and deceptive business practice. TI is not responsible or liable for such altered documentation.

Resale of TI products or services with statements different from or beyond the parameters stated by TI for that product or service voids all express and any implied warranties for the associated TI product or service and is an unfair and deceptive business practice. TI is not responsible or liable for any such statements.

Following are URLs where you can obtain information on other Texas Instruments products and application solutions:

Products		Applications	
Amplifiers	amplifier.ti.com	Audio	www.ti.com/audio
Data Converters	dataconverter.ti.com	Automotive	www.ti.com/automotive
DSP	dsp.ti.com	Broadband	www.ti.com/broadband
Interface	interface.ti.com	Digital Control	www.ti.com/digitalcontrol
Logic	logic.ti.com	Military	www.ti.com/military
Power Mgmt	power.ti.com	Optical Networking	www.ti.com/opticalnetwork
Microcontrollers	microcontroller.ti.com	Security	www.ti.com/security
		Telephony	www.ti.com/telephony
		Video & Imaging	www.ti.com/video
		Wireless	www.ti.com/wireless

Mailing Address: Texas Instruments
Post Office Box 655303 Dallas, Texas 75265

Copyright © 2003, Texas Instruments Incorporated