

# Dual operational amplifier

## BA728 / BA728F / BA728N

The BA728, BA728F, and BA728N are ICs with two independently functioning operational amplifiers featuring internal phase compensation. These products offer a wide range of operating voltages, from 3 to 18V ( $\pm 1.5$  to 9V) and are high-performance operational amplifiers which can be driven from a single power supply within the in-phase mode input range, including a negative power supply.

### ●Applications

- Ground sensing small-signal amplifiers
- Control amplifiers requiring high phase margin, such as motor drivers
- Amplifiers operated on low voltages
- Capacitive loaded amplifiers

### ●Features

- 1) Can be driven from a single power supply.
- 2) Low power.
- 3) Pin layout is the same as that of the general-purpose 4558 operational amplifier.
- 4) When driven from a single power supply, the power supply voltage ranges from 3 to 18V.
- 5) When driven from a dual power supply, the power supply voltage ranges from  $\pm 1.5$  to  $\pm 9V$ .
- 6) Output is protected against short-circuits.
- 7) Output block is operated as a class AB to minimize crossover distortion.
- 8) Low input bias current of 10nA (typ.).
- 9) Each package contains two operational amplifiers.
- 10) Internal phase compensation provided.

### ●Block diagram

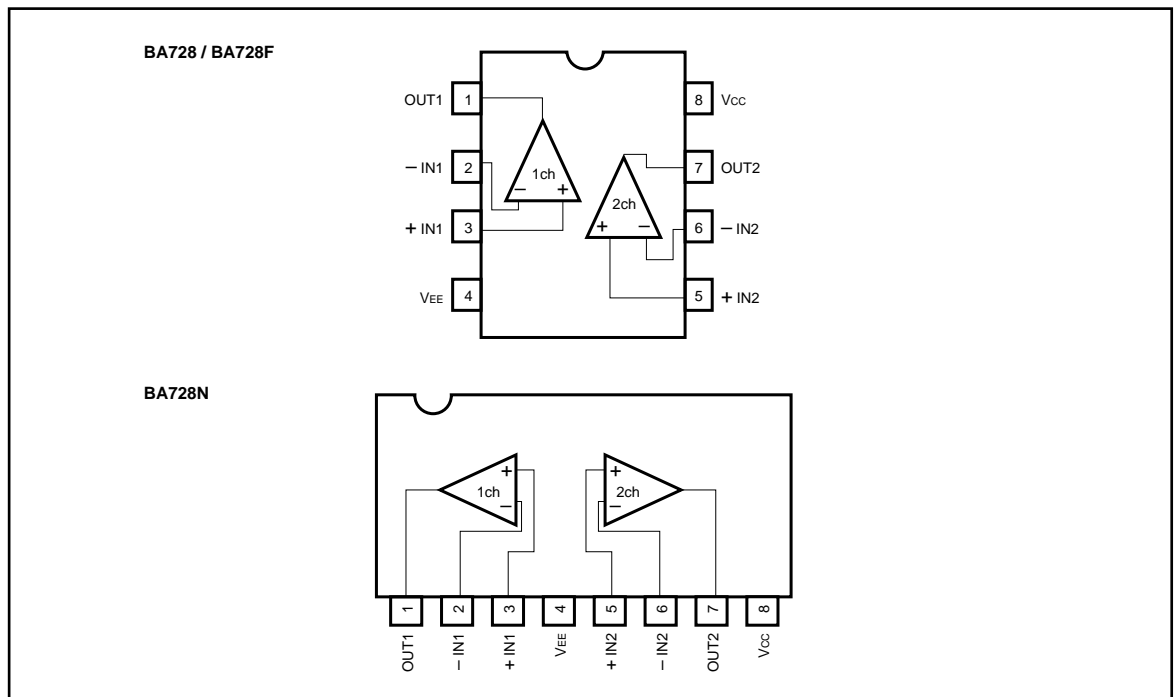

●Internal circuit configuration

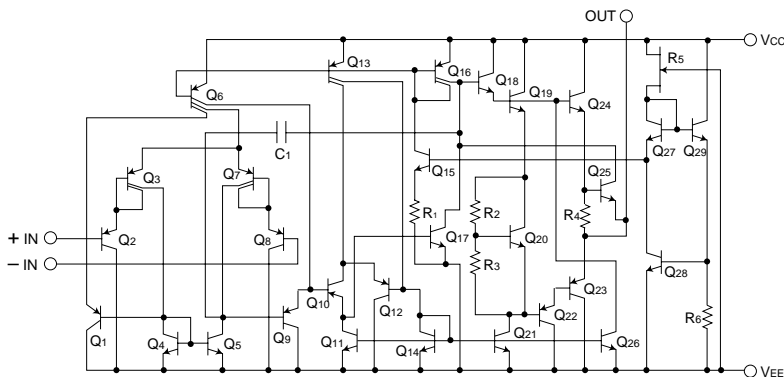

●Absolute maximum ratings (Ta = 25°C)

| Parameter                  | Symbol           | Limits                    |                           |                           | Unit |
|----------------------------|------------------|---------------------------|---------------------------|---------------------------|------|
|                            |                  | BA728                     | BA728F                    | BA728N                    |      |
| Power supply voltage       | V <sub>CC</sub>  | 18 (± 9)                  | 18 (± 9)                  | 18 (± 9)                  | V    |
| Power dissipation          | P <sub>d</sub>   | 800*                      | 550*                      | 550*                      | mW   |
| Differential input voltage | V <sub>ID</sub>  | V <sub>CC</sub>           | V <sub>CC</sub>           | V <sub>CC</sub>           | V    |
| Common-mode input voltage  | V <sub>I</sub>   | - 0.3 ~ + V <sub>CC</sub> | - 0.3 ~ + V <sub>CC</sub> | - 0.3 ~ + V <sub>CC</sub> | V    |
| Operating temperature      | T <sub>opr</sub> | - 20 ~ + 75               | - 20 ~ + 75               | - 20 ~ + 75               | °C   |
| Storage temperature        | T <sub>stg</sub> | - 55 ~ + 125              | - 55 ~ + 125              | - 55 ~ + 125              | °C   |

\* Refer to Pd characteristics diagram.

\* The values for the BA728F are those when it is mounted on a glass epoxy PCB (50mm × 50mm × 1.6mm).

●Electrical characteristics (unless otherwise noted, Ta = 25°C, V<sub>CC</sub> = + 6V, V<sub>EE</sub> = - 6V)

| Parameter                            | Symbol           | Min.                | Typ.      | Max. | Unit   | Conditions                               |  |
|--------------------------------------|------------------|---------------------|-----------|------|--------|--|--|
| Input offset voltage                 | V <sub>IO</sub>  | —                   | 2         | 10   | mV     |  |  |
| Input offset current                 | I <sub>IO</sub>  | —                   | 1         | 50   | nA     |  |  |
| Input bias current                   | I <sub>B</sub>   | —                   | 10        | 250  | nA     |  |  |
| High-amplitude voltage gain          | A <sub>v</sub>   | 86                  | 100       | —    | dB     | R <sub>L</sub> ≧ 2kΩ                     |  |
| Common-mode input voltage            | V <sub>ICM</sub> | 4 ~ - 6             | 4.5 ~ - 6 | —    | V      |  |  |
| Maximum output voltage               | V <sub>OM</sub>  | ± 3.0               | ± 4.5     | —    | V      | R <sub>L</sub> ≧ 2kΩ                     |  |
| Common mode rejection ratio          | CMRR             | 70                  | 90        | —    | dB     |  |  |
| Power supply voltage rejection ratio | PSRR             | —                   | 30        | 150  | μV / V |  |  |
| Slew rate                            | S. R.            | —                   | 0.7       | —    | V / μs | A <sub>v</sub> = 1, R <sub>L</sub> = 2kΩ |  |
| Maximum frequency                    | f <sub>T</sub>   | —                   | 0.7       | —    | MHz    |  |  |
| Channel separation                   | CS               | —                   | 120       | —    | dB     |  |  |
| Maximum output current               | source           | I <sub>source</sub> | —         | 20   | —      | mA                                       | V <sub>IN+</sub> = 1V, V <sub>IN-</sub> = 0V |
|                                      | sink             | I <sub>sink</sub>   | —         | 10   | —      | mA                                       | V <sub>IN-</sub> = 1V, V <sub>IN+</sub> = 0V |

● Measurement circuits

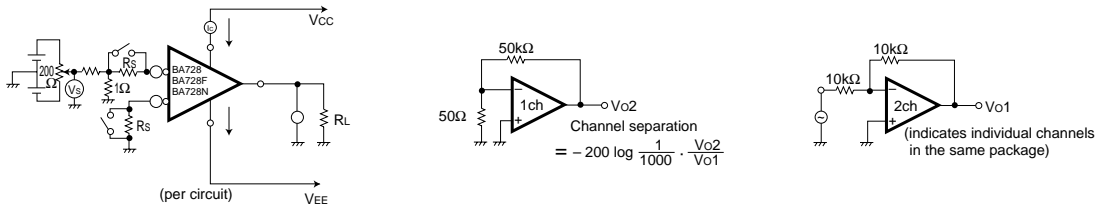

Fig. 1 Channel separation measurement circuit

● Electrical characteristic curves

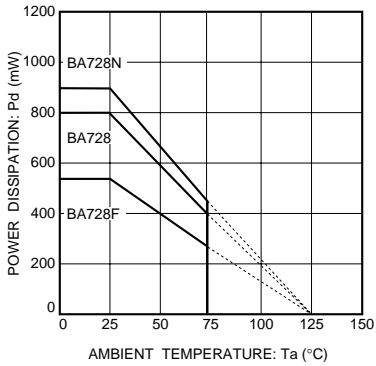

Fig.2 Power dissipation vs. ambient temperature

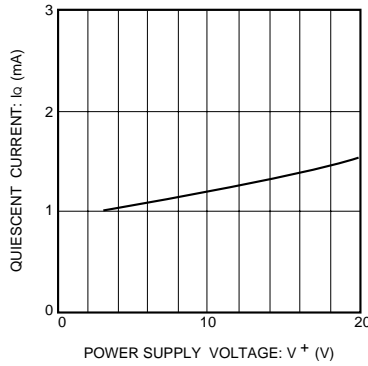

Fig.3 Quiescent current vs. power supply voltage

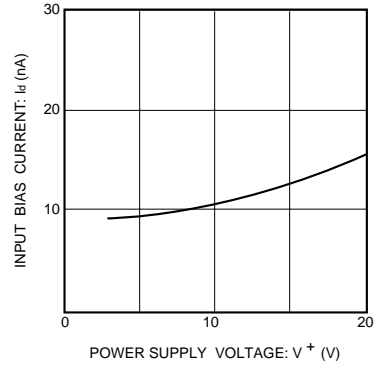

Fig.4 Input bias current vs. power supply voltage

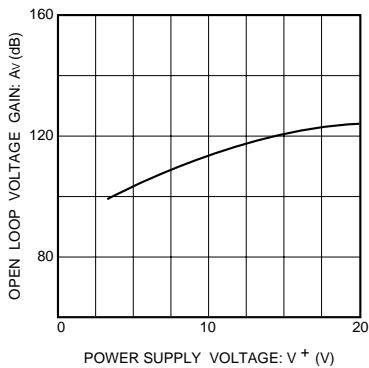

Fig.5 Open loop voltage gain vs. power supply voltage

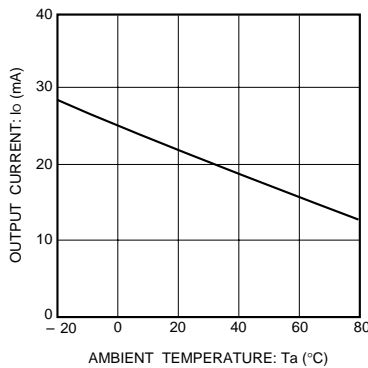

Fig.6 Current control characteristics

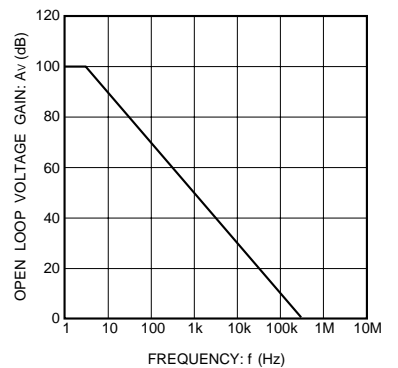

Fig.7 Open loop voltage gain vs. frequency

●Electrical characteristic curve

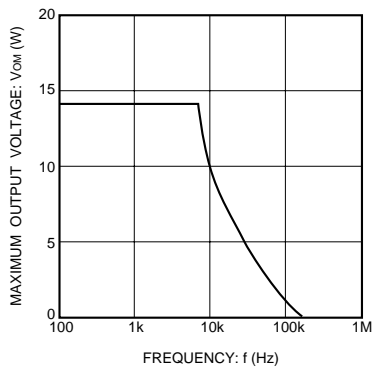

Fig.8 Maximum output voltage vs. frequency

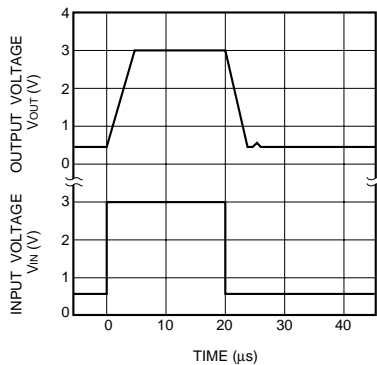

Fig.9 Output response characteristics

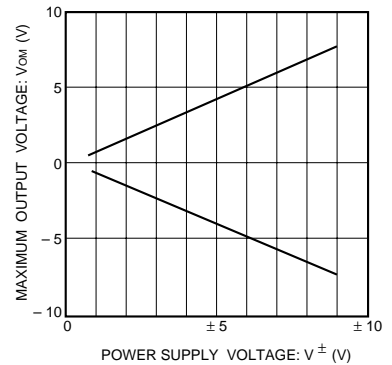

Fig.10 Maximum output voltage vs. power supply voltage

●Operation notes

(1)Unused circuit connections

If there are any circuits which are not being used, we recommend making connections as shown in Figure 11, with the non-inverted input pin connected to the potential within the in-phase input voltage range ( $V_{ICM}$ ).

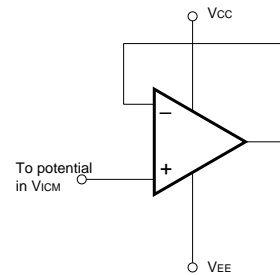

Fig.11 Unused circuit connections

●External dimensions (Units: mm)

