

BA6885FS BA6886 BA6885FP BA6886N

30-V dc reversible-motor driver

The BA6885FS/FP and the BA6886/N are 30-V dc motor drivers that can drive small dc motors. They are suitable for applications using 24 V.

Features

- available in SSOP-A16, HSOP24, SIP10, and HSIP10 packages
- supply voltage range (6.5 ~ 28 V)
- power dissipation 1500 mW (BA6885FP), 800 mW (BA6885FS), 2000 mW (BA6886), and 1050 mW (BA6886N)
- output motor driving current up to 1000 mA
- two control logic inputs allow switching of 4 output states (forward, reverse, stop, and braking)
- built-in surge-absorbing diodes
- built-in thermal shutdown circuit (TSD)
- built-in power saving circuit minimizes current consumption at motor stop
- adjustable output voltage enables motor speed control using control pin voltage
- logic and power units have isolated grounds allowing for an electronic governor circuit on the IC output
- interfaces with TTL and CMOS devices

Applications

- OA devices, industrial devices, and automobiles

Dimensions (Units : mm)

BA6885FS (SSOP-A16)

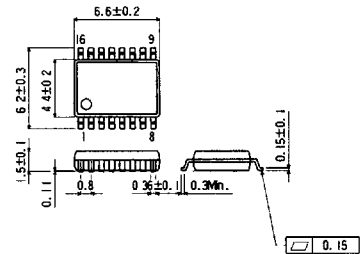

BA6885FP (HSOP24)

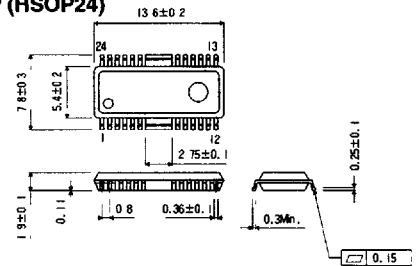

BA6886N (SIP10)

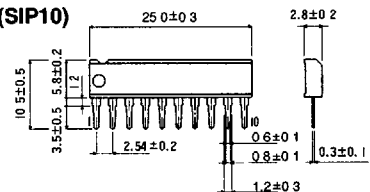

BA6886 (HSIP10)

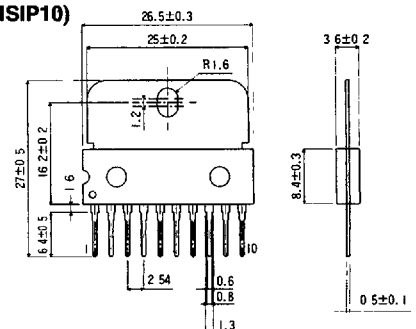

Table 1 Pin description and block diagrams (Sheet 1 of 2)

Pin no.	Symbol	Description	Pin layout	
BA6885FS				
1	GND	Ground connection		
3	OUT1	Motor drive output		
4	V_M	Motor supply voltage		
5	V_{CC}	Supply voltage		
6	F_{IN}	Logic input		
8	POWER SAVE	Power save mode select. LOW ($\leq 0.8\text{ V}$) = normal mode; HIGH ($\geq 2.0\text{ V}$) = power save (standby) mode		
11	R_{IN}	Logic input		
12	V_{REF}	Pin used to set output voltage HIGH		
14	OUT2	Motor drive output		
16	RNF	Output section GND. Connection point for output current sensing resistor		
2, 7, 9, 10, 13, 15	NC	Not used		
BA6885FP				
5	OUT2	Motor drive output		
6	RNF	Output section GND pin. Connection point for output current-sensing resistor		
7	GND	Ground connection		
8	OUT1	Motor drive output		
15	V_M	Motor supply voltage		
16	V_{CC}	Supply voltage		
17	F_{IN}	Logic input		
18	POWER SAVE	Power save mode select. LOW ($\leq 0.8\text{ V}$) = normal mode; HIGH ($\geq 2.0\text{ V}$) = power save (standby) mode		
19	R_{IN}	Logic input		
20	V_{REF}	Pin used to set output voltage HIGH		
1, 2, 3, 4, 9, 10, 11, 12, 13, 14, 21, 22, 23, 24	NC	Not used Note: The external fin should be grounded to the ground pin and to the PCB ground		

Table 1 Pin description and block diagrams (Sheet 2 of 2)

Pin no.	Symbol	Description	Pin layout
BA6886/N			
1	GND	Ground connection	
2	R _{IN}	Logic input	
3	V _{REF}	Pin used to set output voltage HIGH	
4	OUT2	Motor drive output	
5	RNF	Output section GND pin. Connection point for output current	
6	GND	Ground connection	
7	OUT1	Motor drive output	
8	V _M	Motor supply voltage	
9	V _{CC}	Supply voltage	
10	F _{IN}	Logic input	

Absolute maximum ratings (T_a = 25°C)

Parameter	Symbol	Limits	Unit	Conditions
Supply voltage	V _{CC}	30	V	
Power dissipation	BA6885FS	800	mW	Reduce power by 6.4 mW for each degree above 25°C. Mounted on 90 × 50 × 1.6 mm glass epoxy PCB.
	BA6885FP	1500		Reduce power by 12 mW for each degree above 25°C. Mounted on 90 × 50 × 1.6 mm glass epoxy PCB.
	BA6886	2000		Reduce power by 16 mW for each degree above 25°C.
	BA6886N	1050		Reduce power by 8.4 mW for each degree above 25°C.
Output current	I _{OUT}	1000	mA	Maximum P _d and ASO ratings must never be exceeded.
Operating temperature	T _{opr}	-20 ~ +75	°C	
Storage temperature	T _{stg}	-55 ~ +150	°C	

Recommended operating conditions (T_a = 25°C)

Parameter	Symbol	Min	Typical	Max	Unit
Supply voltage	V _{CC}	6.5		28	V
	V _M	6.5		28	V

Electrical characteristics (unless otherwise noted, $T_a = 25^\circ\text{C}$, $V_{CC} = 12\text{ V}$, $V_M = 12\text{ V}$)

Parameter	Symbol	Min	Typical	Max	Unit	Conditions
Current consumption 1	I_{CC1}	4.5	9.0	13.5	mA	Forward or reverse mode
Current consumption 2	I_{CC2}	8.0	16	24	mA	Brake mode
Current consumption 3	I_{CC3}			15	μA	Standby mode
REF bias current	I_{REF}	80	165	250	μA	Forward or reverse mode, $V_{REF} = 6\text{ V}$, $I_O = 200\text{ mA}$
Input voltage HIGH	V_{IH}	2.0			V	
Input voltage LOW	V_{IL}			0.8	V	
Input current HIGH	I_{IH}	45	90	135	μA	$V_{IN} = 2.0\text{ V}$
Output saturation voltage	V_{CE}	1.1	2.2	3.3	V	$I_O = 200\text{ mA}$, sum of high and low side output transistor C-E voltages
Power saver OFF voltage	$V_{PS\ OFF}$			0.8	V	Normal operation
Power saver ON voltage	$V_{PS\ ON}$	2.0			V	Standby operation

Figure 1 Input and output equivalent circuits

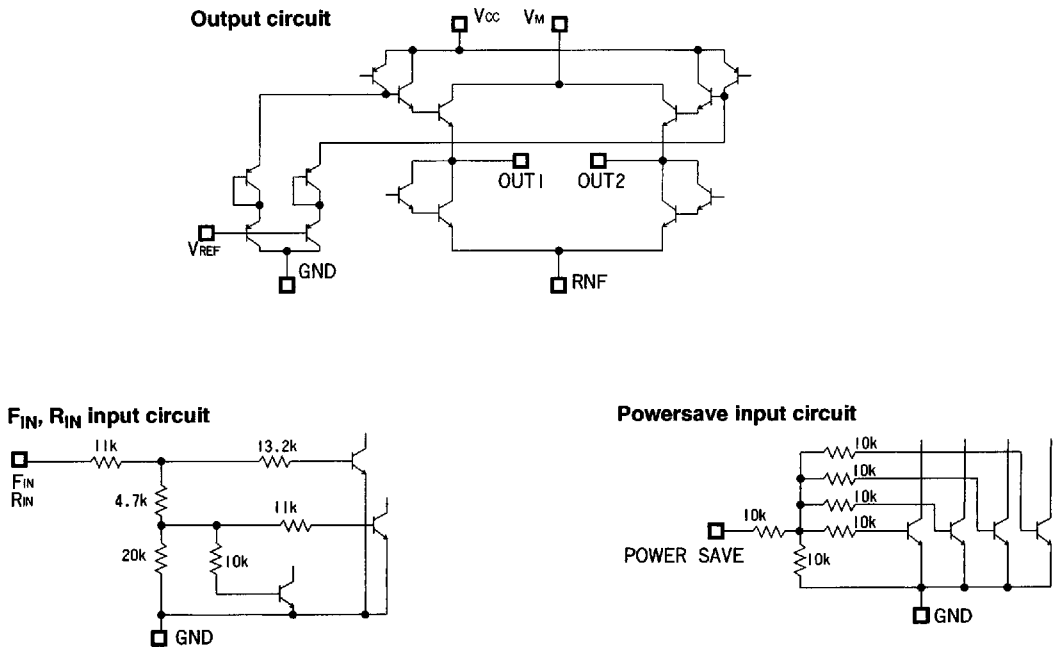
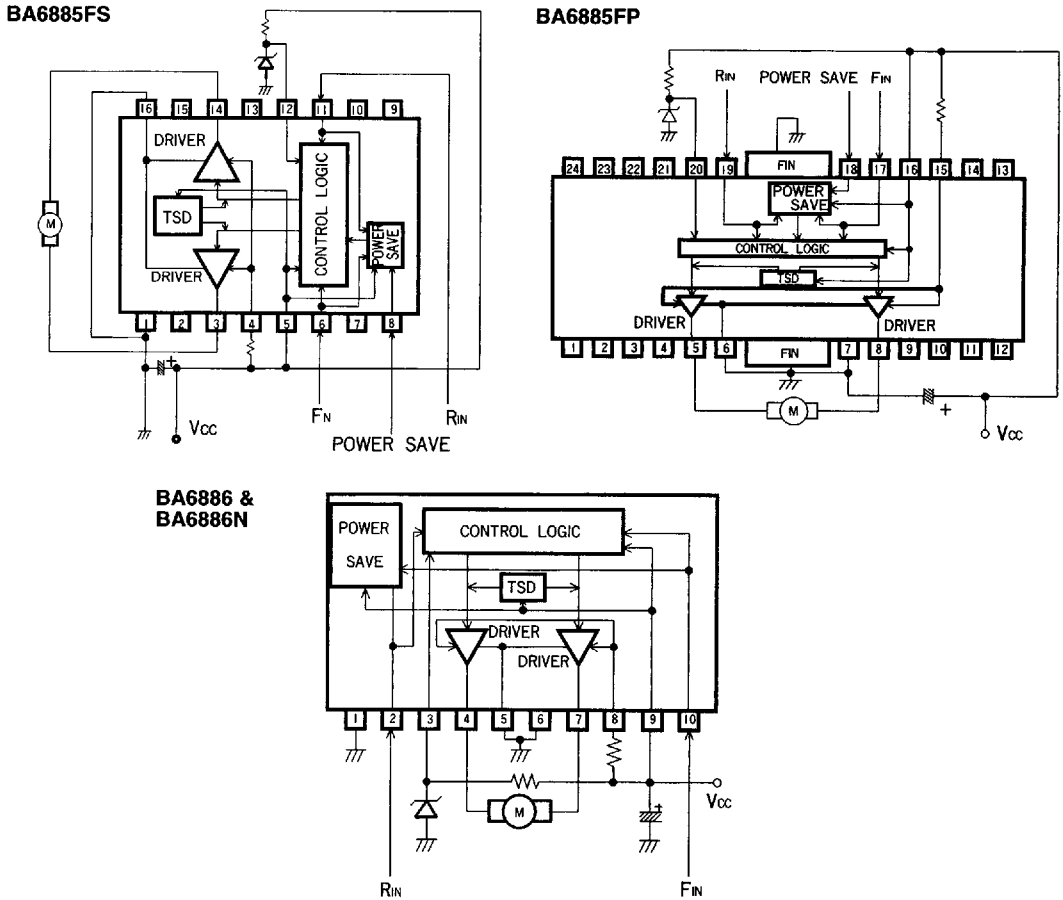

Figure 2 Application examples



Circuit operation

Input section

There are four output modes that are selected by the states of two logic inputs, as indicated in the logic inputs and outputs truth table. When F_{IN} is HIGH and R_{IN} is LOW, the direction of motor drive current is from OUT1 to OUT2. When R_{IN} is HIGH and F_{IN} is LOW, the drive current flows from OUT2 to OUT1.

When in standby mode, Power save is in operation. This mode can also be entered by setting the Powersave pin HIGH

The input circuit accepts TTL or higher logic input voltages.

Logic inputs and outputs

F _{IN}	R _{IN}	OUT1	OUT2	Conditions
HIGH	LOW	HIGH	LOW	Forward
LOW	HIGH	LOW	HIGH	Reverse
HIGH	HIGH	LOW	LOW	Brake
LOW	LOW	Open	Open	Stop/Standby

Output section

The forward direction of the motor is defined as the direction of rotation when the current flow is from OUT1 to OUT2. The reverse direction is the direction of rotation when the current flow is from OUT2 to OUT1. The HIGH and LOW output voltage levels V_{OH} and V_{OL} are given by the equations:

$$V_{OH} (V) \cong V_{REF} \text{ and } V_{REF} \leq V_{CC} - (V_{CE(sat)}(PNP) + 2V_{BE}(NPN))$$

$$V_{OL} (V) = V_{CE(sat)}(NPN) + V_{BE}(NPN)$$

V_{CE} and V_{BE} are functions of the output current (refer to the electrical characteristic curves). When the V_{REF} pin is not used to control V_{OH} , it should be left open, or connected to the V_{CC} pin.

Voltage supply pins (V_{CC} and V_M)

The V_{CC} pin supplies voltage to the logic section, and the V_M pin supplies voltage to the motor section.

Power save circuit

Setting both input pins (F_{IN} and R_{IN}) LOW, or setting the Power save pin HIGH turns off all circuits. This function can be used to save power in the standby mode. The outputs are open when the power save mode is active.

Thermal shutdown (TSD) circuit

Regardless of the operating mode as defined by the input, the thermal shutdown circuit turns off the driver output if the temperature of the IC (junction temperature) rises to approximately 175°C (typical). There is about a 15°C difference (typical) between the temperatures at which the TSD circuit activates and clears. The shutdown signal is not latched. This means the IC automatically turns on again when it cools down. When it clears, the outputs immediately assume the states defined by the logic input.

Output section GND, output current sensing resistor (RNF) connect pin

The current flowing in the motor can be monitored by the voltage across a resistor connected between this pin and ground. An external electronic governor circuit can be configured using this voltage to control V_{REF} to provide a constant-speed reversible motor driver.

Precautions for use

Change in motor direction

For improved reliability, when reversing the motor, the input should momentarily be set to the open state as an intermediate step between application of the forward and reverse (or reverse and forward) mode inputs.

Control logic

Voltage should never be applied to the control logic (F_{IN} , R_{IN} , or Powersave) pins unless V_{CC} is already applied to the IC. Similarly, when V_{CC} is applied to the IC, the voltage on the input pins should not be allowed to rise above V_{CC} .

Output high level voltage control pin (V_{REF})

Steps should be taken to ensure that the voltage applied to the V_{REF} pin does not exceed the voltage on the motor supply voltage pin (V_M), or the V_{CC} voltage pin.

PCB foil

When a motor is being driven (especially when the direction of rotation is being reversed), large currents up to several hundred milliamperes flow between the V_M and RNF pins.

Due to the layout of the conductor pattern, large output currents can cause spurious coupling back to the input that can result in detrimental effects (such as erratic operation or oscillations). To avoid this, the PCB designer should be careful to ensure that the large current output foils do not have a common impedance with the input section. Since a high impedance power supply also creates a tendency to oscillate, the supply impedance should be kept low.

Package power

The amount of power dissipated by the IC varies widely with the power supply voltage and the output current. Always give full consideration to the package power dissipation when setting the supply voltage and output current.

ASO

Always set output current and supply voltage such that the ASO will not be exceeded.

Motor section supply voltage pin (V_M)

A resistor connected between the V_M pin and the power supply limits the large current that flows at motor startup, and thus serves to reduce the power dissipated within the IC. Use a resistor of less than 10Ω for this purpose.

Restriction

Ensure that the following restrictions are applied in all applications for these ICs:

- The ground pins must always be maintained at or below the potential of all other pins.

BA6885FS, BA6885FP, BA6886, BA6886N Reversible-motor driver

- Since the input and Powersave pins of these devices have temperature characteristics, always consider such factors during circuit design.
- To eliminate motor noise, external components should be connected at OUT1 and OUT2 as shown in Figure 3. Either connect a capacitor between each output pin and ground, or connect diodes between each output pin and ground, with a capacitor connected between the two pins.

Figure 3 Output circuit arrangements

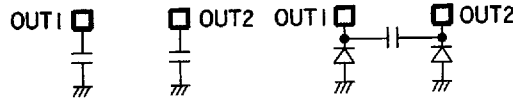

Electrical characteristic curves

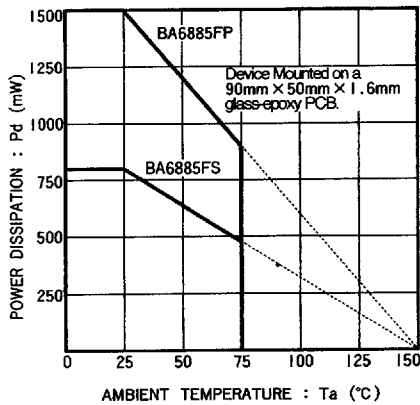

Figure 4 BA6885FS and BA6885FP

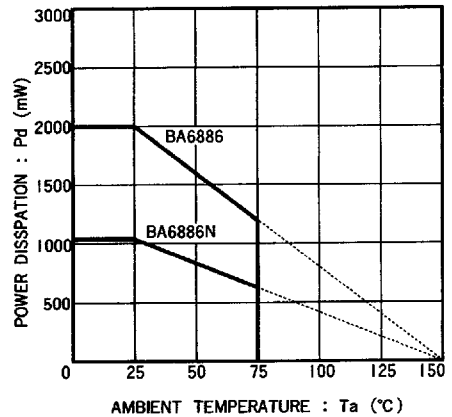

Figure 5 BA6886 and BA6886N

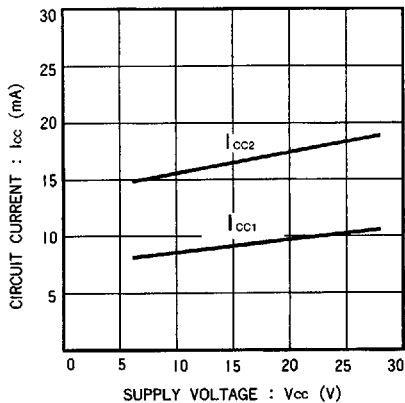

Figure 6

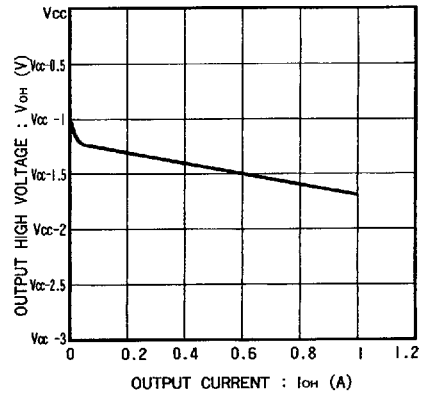

Figure 7

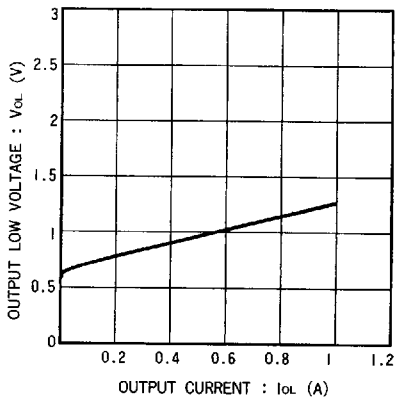

Figure 8

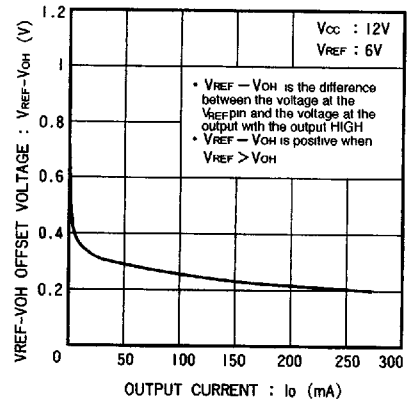

Figure 9

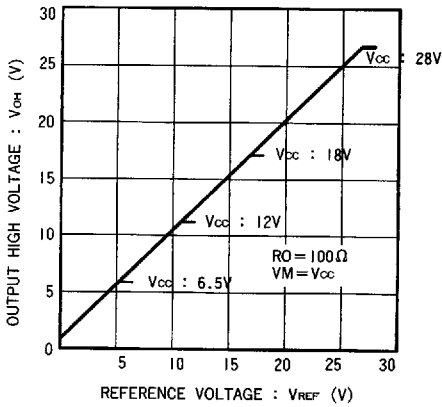

Figure 10