

AN77L00/AN77L00M Series

3-pin Low Power Loss Voltage Regulator (100mA Type)

■ Overview

The AN77L00/AN77L00M series is a stabilized constant voltage power supply with a low input/output voltage (0.3V max.). It is suitable for the low-voltage equipment using batteries, and consumer/industrial equipment with great fluctuation of the supply voltage.

A wide range of output voltage is available from 3V through 10V.

■ Features

- Minimum input/output voltage difference : 0.3V(max.)
- Built-in overcurrent limiting circuit
- Built-in rush current preventive circuit at saturation voltage rise time
- Built-in overheat protective circuit
- Built-in input short-circuit protective circuit

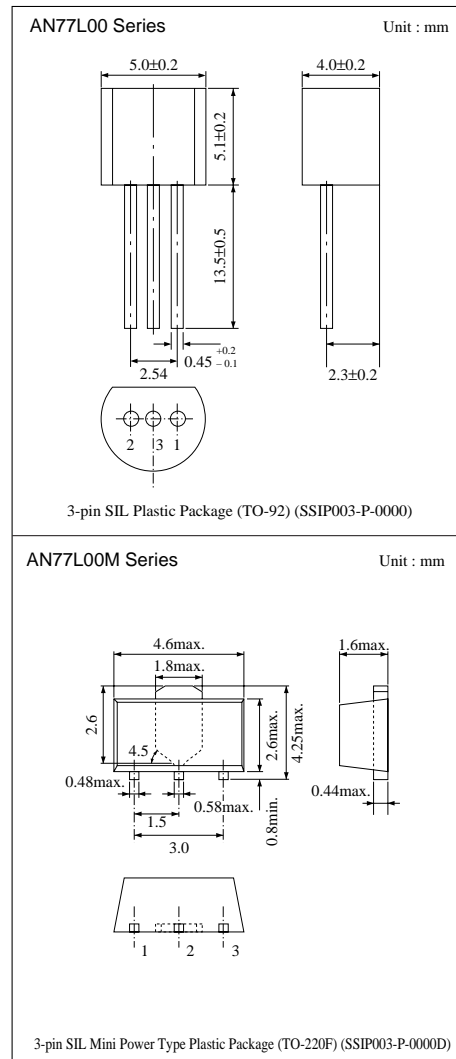

■ Block Diagram

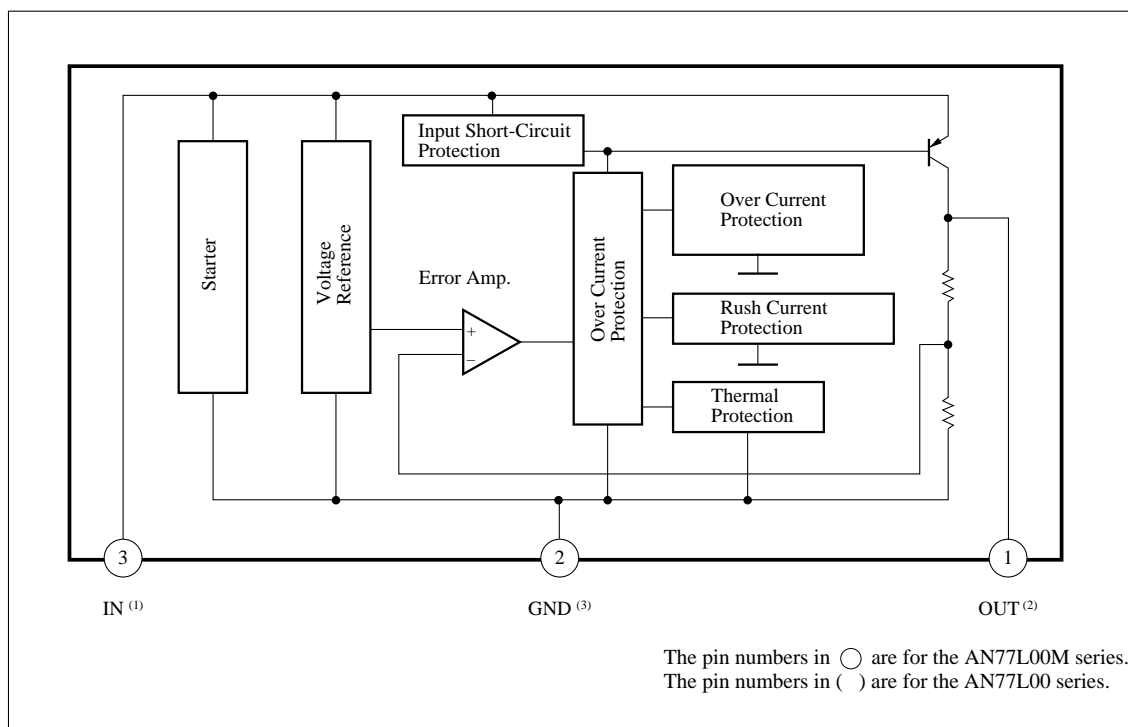

■ Absolute Maximum Ratings ($T_a=25^\circ\text{C}$)

Parameter	Symbol	Rating	Unit
Supply voltage	V_{IN}	30	V
Supply current	I_{IN}	200	mA
Power dissipation <small>Note 1)</small>	P_D	650	mW
Operating ambient temperature	T_{opr}	-30 to +85	$^\circ\text{C}$
Storage temperature	T_{stg}	-55 to +150	$^\circ\text{C}$

Note 1)

■ Recommended Operating Range ($T_a=25^\circ\text{C}$)

Part No.	Output voltage (V_o)	Operating supply voltage range (V_i)	Unit
AN77L03/M	3	$V_o + 0.3$ to 13.62	V
AN77L035/M	3.5	$V_o + 0.41$ to 14.14	V
AN77L04/M	4	$V_o + 0.3$ to 14.66	V
AN77L045/M	4.5	$V_o + 0.43$ to 15.18	V
AN77L05/M	5	$V_o + 0.3$ to 15.7	V
AN77L06/M	6	$V_o + 0.46$ to 16.74	V
AN77L07/M	7	$V_o + 0.48$ to 17.78	V
AN77L08/M	8	$V_o + 0.51$ to 18.82	V
AN77L09/M	9	$V_o + 0.53$ to 19.86	V
AN77L10/M	10	$V_o + 0.55$ to 20.9	V
AN77L12/M	12	$V_o + 0.6$ to 22.98	V

■ Electrical Characteristics (Ta=25°C)

• AN77L03/M (3V, 100mA Type)

Parameter	Symbol	Condition	min	typ	max	Unit
Output voltage	V _O	T _j =25°C	2.88	3	3.12	V
Input stability	REG _{IN}	V _I =3.62 to 13.62V, T _j =25°C	—	2	60	mV
Load stability	REG _L	I _O =0 to 100mA, T _j =25°C	—	8	60	mV
Bias current under no load	I _{bias}	I _O =0mA, T _j =25°C	—	0.9	1.5	mA
Bias current fluctuation under load	ΔI _{bias}	I _O =0 to 100mA, T _j =25°C	—	3	5	mA
Bias current before regulation start	I _{rush}	V _I =2.7V, I _O =0mA, T _j =25°C	—	1.5	5	mA
Ripple rejection ratio	RR	V _I =3.62 to 5.62V, f=120Hz	60	70	—	dB
Min. input/output voltage difference (1)	V _{DIF (min) 1}	V _I =2.7V, I _O =50mA, T _j =25°C	—	0.12	0.25	V
Min. input/output voltage difference (2)	V _{DIF (min) 2}	V _I =2.7V, I _O =100mA, T _j =25°C	—	0.22	0.3	V
Output noise voltage	V _{no}	f=10Hz to 100kHz	—	70	—	μV
Output voltage temperature coefficient	ΔV _O /Ta	T _j = -30 to +125°C	—	0.2	—	mV/°C

Note 1) Under T_j=25°C, each test duration can be set short (within 10ms) and the characteristic drift with temperature rise at joints of the chip may be ignored.

Note 2) V_I=4V, I_O=50mA, C_O=10μF unless otherwise specified.

• AN77L035/M (3.5V, 100mA Type)

Parameter	Symbol	Condition	min	typ	max	Unit
Output voltage	V _O	T _j =25°C	3.36	3.5	3.64	V
Input stability	REG _{IN}	V _I = 4.14 to 14.14V, T _j =25°C	—	3	60	mV
Load stability	REG _L	I _O = 0 to 100mA, T _j = 25°C	—	9	60	mV
Bias current under no load	I _{bias}	I _O = 0mA, T _j = 25°C	—	0.9	1.5	mA
Bias current fluctuation under load	ΔI _{bias}	I _O = 0 to 100mA, T _j = 25°C	—	3	5	mA
Bias current before regulation start	I _{rush}	V _I = 3.15V, I _O = 0mA, T _j =25°C	—	1.5	5	mA
Ripple rejection ratio	RR	V _I = 4.14 to 6.14V, f=120Hz	59	69	—	dB
Min. input/output voltage difference (1)	V _{DIF (min) 1}	V _I = 3.15V, I _O = 50mA, T _j = 25°C	—	0.12	0.25	V
Min. input/output voltage difference (2)	V _{DIF (min) 2}	V _I = 3.15V, I _O =100mA, T _j = 25°C	—	0.22	0.41	V
Output noise voltage	V _{no}	f=10Hz to 100kHz	—	75	—	μV
Output voltage temperature coefficient	ΔV _O /Ta	T _j = -30 to +125°C	—	0.23	—	mV/°C

Note 1) Under T_j=25°C, each test duration can be set short (within 10ms) and the characteristic drift with temperature rise at joints of the chip may be ignored.

Note 2) V_I=4.5V, I_O=50mA, C_O=10μF unless otherwise specified.

• AN77L04/M (4V, 100mA Type)

Parameter	Symbol	Condition	min	typ	max	Unit
Output voltage	V _O	T _j =25°C	3.84	4	4.16	V
Input stability	REG _{IN}	V _I = 4.66 to 14.66V, T _j = 25°C	—	3	60	mV
Load stability	REG _L	I _O = 0 to 100mA, T _j = 25°C	—	9	60	mV
Bias current under no load	I _{bias}	I _O = 0mA, T _j = 25°C	—	0.9	1.5	mA
Bias current fluctuation under load	ΔI _{bias}	I _O = 0 to 100mA, T _j =25°C	—	3	5	mA
Bias current before regulation start	I _{rush}	V _I =3.6V, I _O = 0mA, T _j = 25°C	—	1.5	5	mA
Ripple rejection ratio	RR	V _I = 4.66 to 6.66V, f=120Hz	59	69	—	dB
Min. input/output voltage difference (1)	V _{DIF (min) 1}	V _I =3.6V, I _O =50mA, T _j = 25°C	—	0.12	0.25	V
Min. input/output voltage difference (2)	V _{DIF (min) 2}	V _I =3.6V, I _O =100mA, T _j = 25°C	—	0.23	0.3	V
Output noise voltage	V _{no}	f=10Hz to 100kHz	—	80	—	μV
Output voltage temperature coefficient	ΔV _O /Ta	T _j = -30 to +125°C	—	0.26	—	mV/°C

Note 1) Under T_j=25°C, each test duration can be set short (within 10ms) and the characteristic drift with temperature rise at joints of the chip may be ignored.

Note 2) V_I=5V, I_O=50mA, C_O=10μF unless otherwise specified.

■ Electrical Characteristics (T_a=25°C)

• AN77L045/M (4.5V, 100mA Type)

Parameter	Symbol	Condition	min	typ	max	Unit
Output voltage	V _O	T _j =25°C	4.32	4.5	4.68	V
Input stability	REG _{IN}	V _I =5.18 to 15.18V, T _j =25°C	—	3	60	mV
Load stability	REG _L	I _O = 0 to 100mA, T _j =25°C	—	10	60	mV
Bias current under no load	I _{bias}	I _O = 0mA, T _j =25°C	—	0.9	1.5	mA
Bias current fluctuation under load	ΔI _{bias}	I _O = 0 to 100mA, T _j =25°C	—	3	5	mA
Bias current before regulation start	I _{rush}	V _I = 4.05V, I _O = 0mA, T _j =25°C	—	1.5	5	mA
Ripple rejection ratio	RR	V _I =7.18 to 6.18V, f=120Hz	58	68	—	dB
Min. input/output voltage difference (1)	V _{DIF (min) 1}	V _I = 4.05V, I _O =50mA, T _j =25°C	—	0.12	0.25	V
Min. input/output voltage difference (2)	V _{DIF (min) 2}	V _I = 4.05V, I _O =100mA, T _j =25°C	—	0.23	0.43	V
Output noise voltage	V _{no}	f=10Hz to 100kHz	—	85	—	μV
Output voltage temperature coefficient	ΔV _O /T _a	T _j = -30 to +125°C	—	0.3	—	mV/°C

Note 1) Under T_j=25°C, each test duration can be set short (within 10ms) and the characteristic drift with temperature rise at joints of the chip may be ignored.

Note 2) V_I=5.5V, I_O=50mA, C_O=10μF unless otherwise specified.

• AN77L05/M (5V, 100mA Type)

Parameter	Symbol	Condition	min	typ	max	Unit
Output voltage	V _O	T _j =25°C	4.8	5	5.2	V
Input stability	REG _{IN}	V _I =5.7 to 15.7V, T _j =25°C	—	4	60	mV
Load stability	REG _L	I _O = 0 to 100mA, T _j =25°C	—	10	60	mV
Bias current under no load	I _{bias}	I _O = 0mA, T _j =25°C	—	0.9	1.5	mA
Bias current fluctuation under load	ΔI _{bias}	I _O = 0 to 100mA, T _j =25°C	—	3	5	mA
Bias current before regulation start	I _{rush}	V _I = 4.5V, I _O = 0mA, T _j =25°C	—	1.5	5	mA
Ripple rejection ratio	RR	V _I = 5.7 to 7.7V, f=120Hz	58	68	—	dB
Min. input/output voltage difference (1)	V _{DIF (min) 1}	V _I = 4.5V, I _O = 50mA, T _j =25°C	—	0.12	0.25	V
Min. input/output voltage difference (2)	V _{DIF (min) 2}	V _I = 4.5V, I _O = 100mA, T _j =25°C	—	0.24	0.3	V
Output noise voltage	V _{no}	f=10Hz to 100kHz	—	90	—	μV
Output voltage temperature coefficient	ΔV _O /T _a	T _j = -30 to +125°C	—	0.33	—	mV/°C

Note 1) Under T_j=25°C, each test duration can be set short (within 10ms) and the characteristic drift with temperature rise at joints of the chip may be ignored.

Note 2) V_I=6V, I_O=50mA, C_O=10μF unless otherwise specified.

• AN77L06/M (6V, 100mA Type)

Parameter	Symbol	Condition	min	typ	max	Unit
Output voltage	V _O	T _j =25°C	5.76	6	6.24	V
Input stability	REG _{IN}	V _I = 6.74 to 16.74V, T _j =25°C	—	4	60	mV
Load stability	REG _L	I _O = 0 to 100mA, T _j =25°C	—	11	60	mV
Bias current under no load	I _{bias}	I _O = 0mA, T _j =25°C	—	0.9	1.5	mA
Bias current fluctuation under load	ΔI _{bias}	I _O = 0 to 100mA, T _j =25°C	—	3	5	mA
Bias current before regulation start	I _{rush}	V _I = 5.4V, I _O = 0mA, T _j =25°C	—	1.5	5	mA
Ripple rejection ratio	RR	V _I = 6.74 to 8.74V, f=120Hz	56	66	—	dB
Min. input/output voltage difference (1)	V _{DIF (min) 1}	V _I =5.4V, I _O =50mA, T _j =25°C	—	0.12	0.25	V
Min. input/output voltage difference (2)	V _{DIF (min) 2}	V _I =5.4V, I _O =100mA, T _j =25°C	—	0.25	0.46	V
Output noise voltage	V _{no}	f=10Hz to 100kHz	—	105	—	μV
Output voltage temperature coefficient	ΔV _O /T _a	T _j = -30 to +125°C	—	0.4	—	mV/°C

Note 1) Under T_j=25°C, each test duration can be set short (within 10ms) and the characteristic drift with temperature rise at joints of the chip may be ignored.

Note 2) V_I=7V, I_O=50mA, C_O=10μF unless otherwise specified.

■ Electrical Characteristics (Ta=25°C)

• AN77L07/M (7V, 100mA Type)

Parameter	Symbol	Condition	min	typ	max	Unit
Output voltage	V _O	T _j =25°C	6.72	7.0	7.28	V
Input stability	REG _{IN}	V _I =7.78 to 17.78V, T _j =25°C	—	5	70	mV
Load stability	REG _L	I _O = 0 to 100mA, T _j =25°C	—	11	70	mV
Bias current under no load	I _{bias}	I _O = 0mA, T _j =25°C	—	1.1	1.6	mA
Bias current fluctuation under load	ΔI _{bias}	I _O = 0 to 100mA, T _j =25°C	—	3	5	mA
Bias current before regulation start	I _{rush}	V _I = 6.3V, I _O = 0mA, T _j =25°C	—	1.5	5	mA
Ripple rejection ratio	RR	V _I =7.78 to 9.78V, f=120Hz	55	65	—	dB
Min. input/output voltage difference (1)	V _{DIF (min)1}	V _I = 6.3V, I _O = 50mA, T _j =25°C	—	0.12	0.25	V
Min. input/output voltage difference (2)	V _{DIF (min)2}	V _I = 6.3V, I _O =100mA, T _j =25°C	—	0.26	0.48	V
Output noise voltage	V _{no}	f=10Hz to 100kHz	—	120	—	μV
Output voltage temperature coefficient	ΔV _O /Ta	T _j = -30 to +125°C	—	0.46	—	mV/°C

Note 1) Under T_j=25°C, each test duration can be set short (within 10ms) and the characteristic drift with temperature rise at joints of the chip may be ignored.

Note 2) V_I= 8V, I_O=50mA, C_O=10μF unless otherwise specified.

• AN77L08/M (8V, 100mA Type)

Parameter	Symbol	Condition	min	typ	max	Unit
Output voltage	V _O	T _j =25°C	7.68	8	8.32	V
Input stability	REG _{IN}	V _I = 8.82 to 18.82V, T _j =25°C	—	5	80	mV
Load stability	REG _L	I _O = 0 to 100mA, T _j =25°C	—	12	80	mV
Bias current under no load	I _{bias}	I _O = 0mA, T _j =25°C	—	1.1	1.6	mA
Bias current fluctuation under load	ΔI _{bias}	I _O = 0 to 100mA, T _j =25°C	—	3	5	mA
Bias current before regulation start	I _{rush}	V _I =7.2V, I _O = 0mA, T _j =25°C	—	1.5	5	mA
Ripple rejection ratio	RR	V _I = 8.82 to 10.82V, f=120Hz	53	63	—	dB
Min. input/output voltage difference (1)	V _{DIF (min)1}	V _I =7.2V, I _O =50mA, T _j = 25°C	—	0.12	0.25	V
Min. input/output voltage difference (2)	V _{DIF (min)2}	V _I =7.2V, I _O =100mA, T _j = 25°C	—	0.27	0.51	V
Output noise voltage	V _{no}	f=10Hz to 100kHz	—	135	—	μV
Output voltage temperature coefficient	ΔV _O /Ta	T _j = -30 to +125°C	—	0.53	—	mV/°C

Note 1) Under T_j=25°C, each test duration can be set short (within 10ms) and the characteristic drift with temperature rise at joints of the chip may be ignored.

Note 2) V_I=9V, I_O=50mA, C_O=10μF unless otherwise specified.

• AN77L09/M (9V, 100mA Type)

Parameter	Symbol	Condition	min	typ	max	Unit
Output voltage	V _O	T _j =25°C	8.64	9	9.36	V
Input stability	REG _{IN}	V _I =9.86 to 19.86V, T _j =25°C	—	6	90	mV
Load stability	REG _L	I _O = 0 to 100mA, T _j =25°C	—	13	90	mV
Bias current under no load	I _{bias}	I _O = 0mA, T _j =25°C	—	1.2	1.7	mA
Bias current fluctuation under load	ΔI _{bias}	I _O = 0 to 100mA, T _j =25°C	—	3	5	mA
Bias current before regulation start	I _{rush}	V _I =8.1V, I _O = 0mA, T _j =25°C	—	1.5	5	mA
Ripple rejection ratio	RR	V _I =9.86 to 11.86V, f=120Hz	52	62	—	dB
Min. input/output voltage difference (1)	V _{DIF (min)1}	V _I =8.1V, I _O = 50mA, T _j =25°C	—	0.13	0.25	V
Min. input/output voltage difference (2)	V _{DIF (min)2}	V _I =8.1V, I _O =100mA, T _j =25°C	—	0.28	0.53	V
Output noise voltage	V _{no}	f=10Hz to 100kHz	—	150	—	μV
Output voltage temperature coefficient	ΔV _O /Ta	T _j =-30 to +125°C	—	0.6	—	mV/°C

Note 1) Under T_j=25°C, each test duration can be set short (within 10ms) and the characteristic drift with temperature rise at joints of the chip may be ignored.

Note 2) V_I=10V, I_O=50mA, C_O=10μF unless otherwise specified.

■ Electrical Characteristics (Ta=25°C)

• AN77L10/M (10V, 100mA Type)

Parameter	Symbol	Condition	min	typ	max	Unit
Output voltage	V_O	$T_j=25^\circ\text{C}$	9.6	10	10.4	V
Input stability	REG_{IN}	$V_I=10.9$ to 20.9V , $T_j=25^\circ\text{C}$	—	7	100	mV
Load stability	REG_{L}	$I_O=0$ to 100mA , $T_j=25^\circ\text{C}$	—	14	100	mV
Bias current under no load	I_{bias}	$I_O=0\text{mA}$, $T_j=25^\circ\text{C}$	—	1.2	1.7	mA
Bias current fluctuation under load	ΔI_{bias}	$I_O=0$ to 100mA , $T_j=25^\circ\text{C}$	—	3	5	mA
Bias current before regulation start	I_{rush}	$V_I=9.0\text{V}$, $I_O=0\text{mA}$, $T_j=25^\circ\text{C}$	—	1.5	5	mA
Ripple rejection ratio	RR	$V_I=10.9$ to 12.9V , $f=120\text{Hz}$	50	60	—	dB
Min. input/output voltage difference (1)	$V_{\text{DIF}(\text{min})1}$	$V_I=9.0\text{V}$, $I_O=50\text{mA}$, $T_j=25^\circ\text{C}$	—	0.13	0.25	V
Min. input/output voltage difference (2)	$V_{\text{DIF}(\text{min})2}$	$V_I=9.0\text{V}$, $I_O=100\text{mA}$, $T_j=25^\circ\text{C}$	—	0.29	0.55	V
Output noise voltage	V_{no}	$f=10\text{Hz}$ to 100kHz	—	165	—	μV
Output voltage temperature coefficient	$\Delta V_O/T_a$	$T_j=-30$ to $+125^\circ\text{C}$	—	0.67	—	$\text{mV}/^\circ\text{C}$

Note 1) Under $T_j=25^\circ\text{C}$, each test duration can be set short (within 10ms) and the characteristic drift with temperature rise at joints of the chip may be ignored.

Note 2) $V_I=11\text{V}$, $I_O=50\text{mA}$, $C_O=10\mu\text{F}$ unless otherwise specified.

• AN77L12/M (12V, 100mA Type)

Parameter	Symbol	Condition	min	typ	max	Unit
Output voltage	V_O	$T_j=25^\circ\text{C}$	11.52	12	12.48	V
Input stability	REG_{IN}	$V_I=12.98$ to 22.98V , $T_j=25^\circ\text{C}$	—	8	120	mV
Load stability	REG_{L}	$I_O=0$ to 100mA , $T_j=25^\circ\text{C}$	—	15	120	mV
Bias current under no load	I_{bias}	$I_O=0\text{mA}$, $T_j=25^\circ\text{C}$	—	1.4	1.9	mA
Bias current fluctuation under load	ΔI_{bias}	$I_O=0$ to 100mA , $T_j=25^\circ\text{C}$	—	3	5	mA
Bias current before regulation start	I_{rush}	$V_I=10.8\text{V}$, $I_O=0\text{mA}$, $T_j=25^\circ\text{C}$	—	1.5	5	mA
Ripple rejection ratio	RR	$V_I=12.98$ to 14.98V , $f=120\text{Hz}$	48	58	—	dB
Min. input/output voltage difference (1)	$V_{\text{DIF}(\text{min})1}$	$V_I=10.8\text{V}$, $I_O=50\text{mA}$, $T_j=25^\circ\text{C}$	—	0.13	0.25	V
Min. input/output voltage difference (2)	$V_{\text{DIF}(\text{min})2}$	$V_I=10.8\text{V}$, $I_O=100\text{mA}$, $T_j=25^\circ\text{C}$	—	0.31	0.6	V
Output noise voltage	V_{no}	$f=10\text{Hz}$ to 100kHz	—	190	—	μV
Output voltage temperature coefficient	$\Delta V_O/T_a$	$T_j=-30$ to $+125^\circ\text{C}$	—	0.8	—	$\text{mV}/^\circ\text{C}$

Note 1) Under $T_j=25^\circ\text{C}$, each test duration can be set short (within 10ms) and the characteristic drift with temperature rise at joints of the chip may be ignored.

Note 2) $V_I=13\text{V}$, $I_O=50\text{mA}$, $C_O=10\mu\text{F}$ unless otherwise specified.

■ Application Circuit

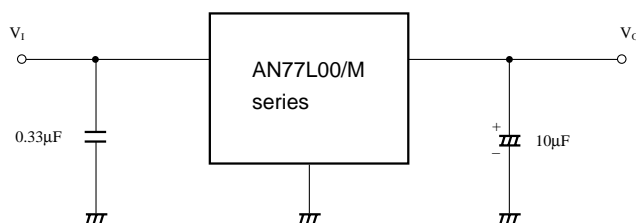

- For the AN77L00/M series, the gain inside the IC is set high to improve the performance. For the reason, use the capacitor of $10\mu\text{F}$ or more when the power line in the output side should be long. In addition, install the capacitor in the output side as near as possible to the IC.

■ Characteristics Curve

Input/Output Characteristics
 $V_O - V_I$

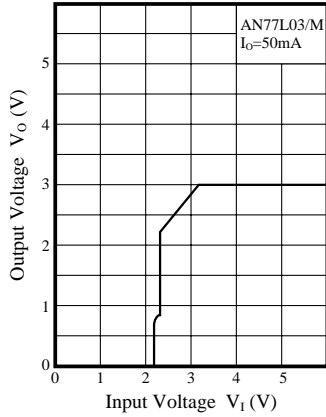

Input Stability
 $V_O - V_I$

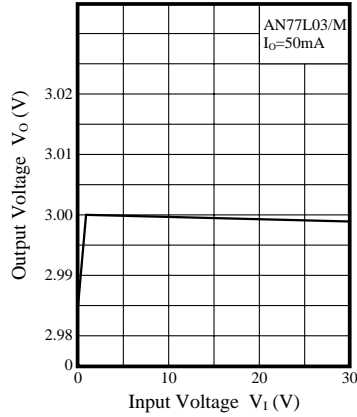

Rush Current (Under No Load)
 $I_I - V_I$

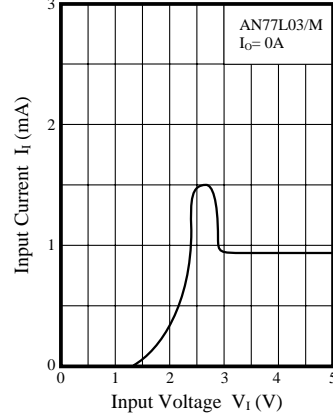

Bias Current
 $I_{\text{bias}} - I_O$

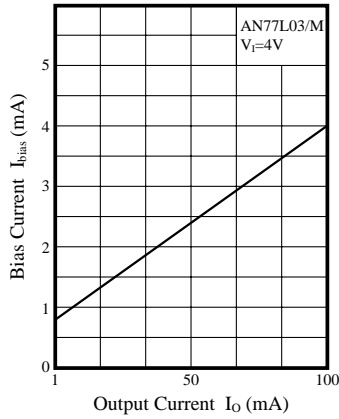

Load Stability
 $V_O - I_O$

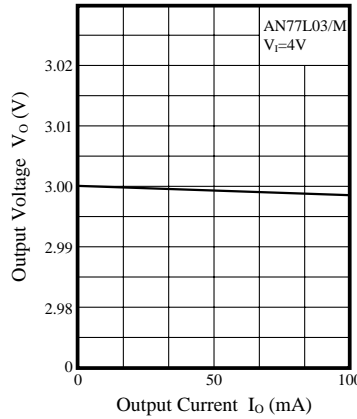

Over-current Limiting Characteristics
 $V_O - I_O$

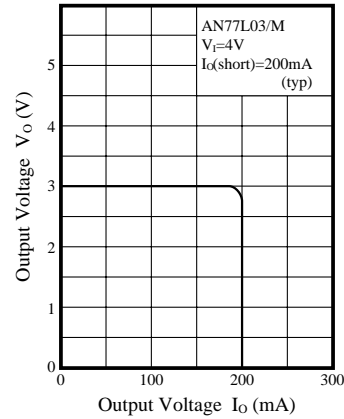

Minimum Input/Output Voltage Difference
 $V_{\text{DIF}(\text{min})} - I_{\text{OUT}}$

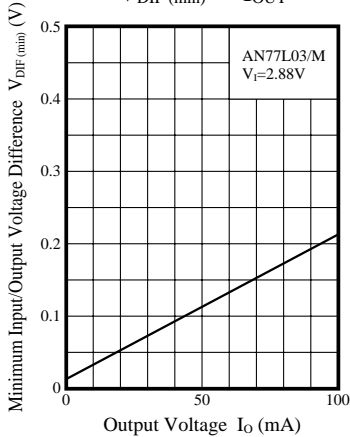

Ripple Rejection Ratio
 $\text{RR} - f$

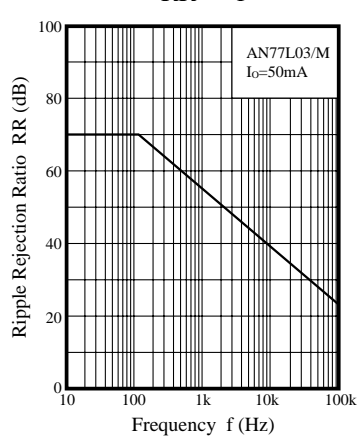

Output Voltage Temperature Characteristics
 $V_O - T_a$

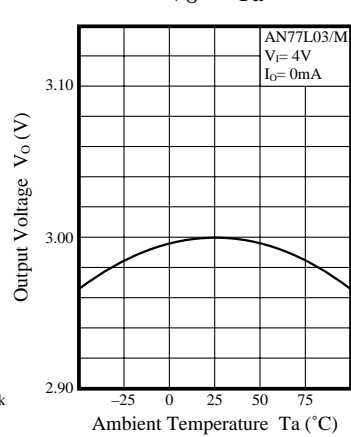

AN77L00 series
[Power Dissipation (TO-92 Package)]
 $P_D - T_a$

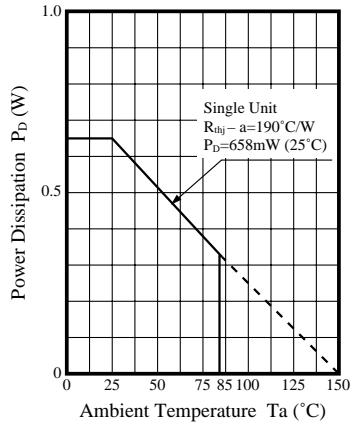

AN77L00M Series
[Power Dissipation (TO-243 Package)]
 $P_D - T_a$

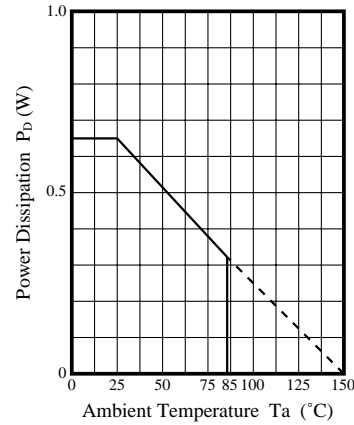

Note) SM to printed board (glass epoxy board of $20 \times 20 \times 1.7\text{mm}$ with copper film of 1cm^2 or more)

■ Precautions on Use

1. Input Short-Circuit Protection Circuit

For the conventional Matsushita 3-pin regulators (such as of the AN8000 series), when DC input pin3 is short-circuited with GND in the normal operation condition, the potential of output pin1 becomes higher than that of DC input pin and the electric charges which is charged in output capacitor C_o flows in the input side, resulting in the breakage of elements.

In the above case, the common silicon diode is connected as shown in the right figure (the dotted line). However, for the AN77L00/M series, since the protection circuit, which protects the elements from the discharging current, is incorporated in the internal circuit, the protection diode is not required.

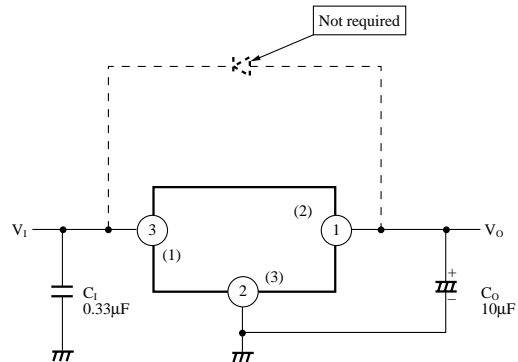

Pin number in ○ is for the AN77L00M series.
Pin number in () is for the AN77L00 series.

2. Capacitor for External Compensation

In order to secure the safety, the capacitor of $10 \mu\text{F}$ is required in the output side and it should be added as near as possible to output pin1 and GND 2. When it is used under low temperature, oscillation may occur due to the decrease of the aluminum electrolytic capacitor and increase of ESR.

For the AN77L00/M, it is recommended that the tantalum capacitor or aluminum electrolytic capacitor whose serial-connected resistance equivalent with that of output capacitor C_o has temperature characteristics within the recommended range specified in the right.

