

AN6162SC

Narrow Band FM Receiver Circuit

Overview

The AN6162SC is an FM receiver IC for the cordless telephone sets.

Features

- Built-in RF amplifier
- Double conversion system
- Built-in waveform shaping comparator
- Built-in squelch circuit

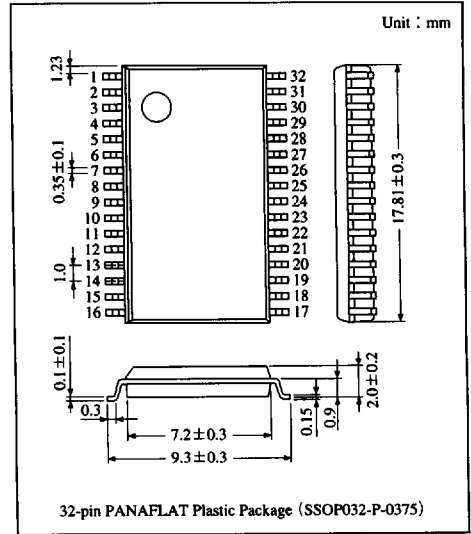

Block Diagram

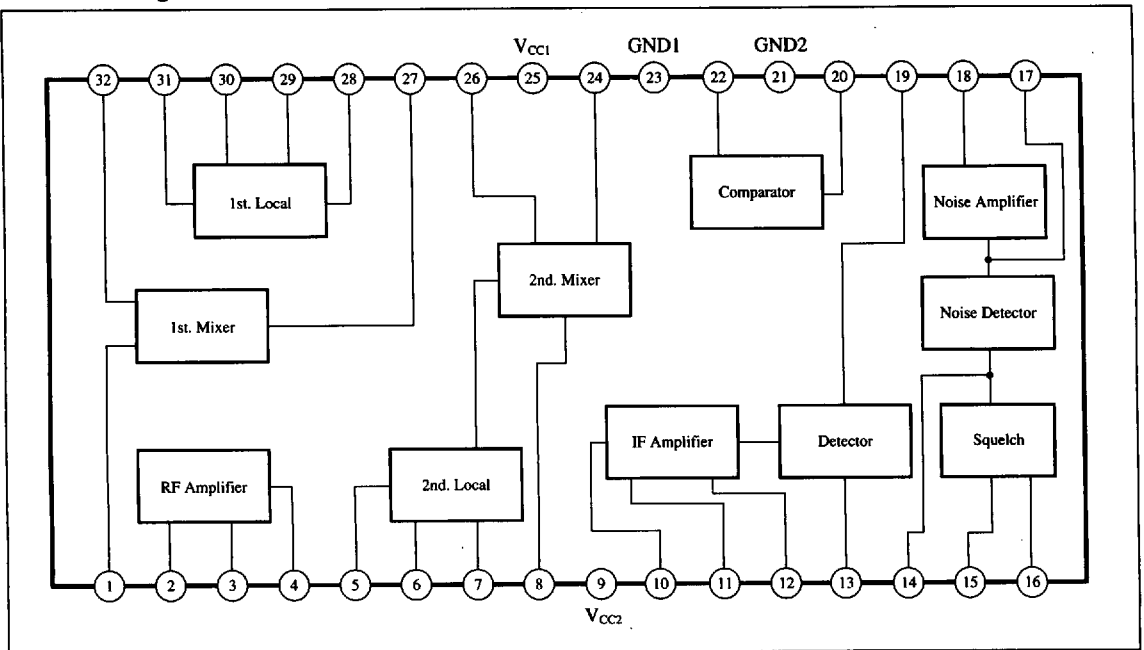

■ 6932852 0013058 312 ■

■ Absolute Maximum Ratings (Ta=25°C)

Parameter	Symbol	Rating	Unit
Supply voltage	V _{CC}	6	V
Supply current	I _{CC}	15	mA
Power dissipation (Ta=75°C)	P _D	294	mW
Operating ambient temperature	T _{opr}	-20 to +75	°C
Storage temperature	T _{stg}	-55 to +125	°C

■ Recommended Operating Range (Ta=25°C)

Parameter	Symbol	Range
Operating supply voltage range	V _{CC}	2 to 5.5V

■ Electrical Characteristics (Ta=25°C)

Parameter	Symbol	Condition	min	typ	max	Unit
Current consumption	I _{CC1}	V _{in} =80dB μ , f _o =455kHz, f _{MOD} =1kHz, Δ f=10kHz Connect 240 Ω to the Pin③ and 5.1k Ω to the Pin②	—	6.2	9	mA
	I _{CC2}	V _{in} =80dB μ , f _o =455kHz, f _{MOD} =1kHz, Δ f=10kHz Open the Pins③ and ②.	—	3.8	5.2	mA
Output voltage	V _O	V _{in} =80dB μ , f _o =455kHz, f _{MOD} =1kHz, Δ f=10kHz Input a signal from the Pin⑩ and measure the output at the Pin⑱.	100	125	180	mVrms
IF input limiting sensitivity	V _L	V _{in} =80dB μ , f _o =455kHz, f _{MOD} =1kHz, Δ f=10kHz Pin⑩ input level when the Pin⑱ output is -3 dB.	—	55	60	dB μ
Mixer gain	G _M	V _{in} =80dB μ , f _o =455kHz, f _{MOD} =1kHz, Δ f=10kHz, Measure the conversion gain between the input Pin④ and output Pin⑧.	59	64	—	dB
Total harmonic distortion	THD	V _{in} =80dB μ , f _o =455kHz, f _{MOD} =1kHz, Δ f=10kHz Input a signal from the Pin⑩ and measure the output at the Pin⑱.	—	1	8	%

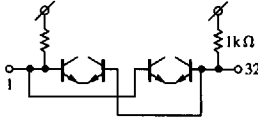
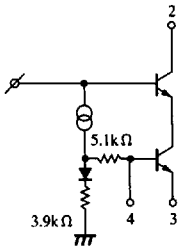
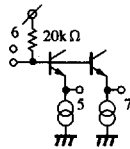
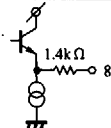
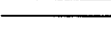
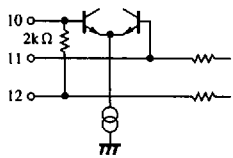
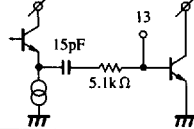
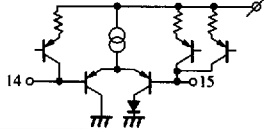
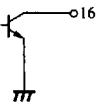
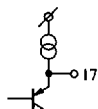

■ Pin Descriptions

Pin No.	Pin name	Description	Equivalent circuit
1	1st mixer input	Input pin of the 1st mixer circuit	
2	RF amplifier collect	Output pin of the RF amplifier	
3	RF amplifier emitter	Emitter ground pin of the RF amplifier	
4	RF amplifier base	Input pin of the RF amplifier	
5	2nd oscillator emitter	External part connection pin of the 2nd oscillator	
6	2nd oscillator base		
7	2nd oscillator output		
8	2nd mixer output	Output of the 2nd mixer circuit	
9	V _{CC2}	Supply voltage pin	
10	IF amplifier input	Input pin of the IF amplifier	
11	IF amplifier decoupling	Bypass capacitor connection pin	
12			
13	Quadrature coil	Detection coil connection pin	
14	Noise detection	Noise detection level adjustment by external resistor	
15	Squelch hysteresis	Hysteresis width adjustment by external resistor	
16	Squelch output	Squelch output pin (open collector)	
17	Noise amplifier output	Noise amplifier output pin	

ICs for Telephone

■ 6932852 0013060 T70 ■

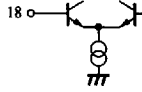
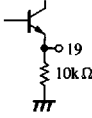
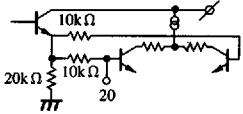
■ Pin Descriptions (cont.)

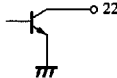
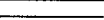
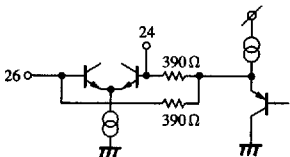
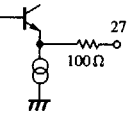
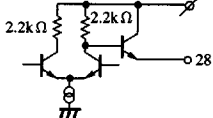
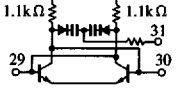
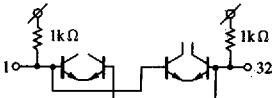
Pin No.	Pin name	Description	Equivalent circuit
18	Noise amplifier input	Noise amplifier input pin	
19	Detection	Detection signal output pin	
20	Comparator input	Comparator input pin	
21	GND2	Ground pin	
22	Comparator output	Comparator output pin (open collector)	
23	GND1	Ground pin	
24	2nd mixer decoupling	Bypass capacitor connection pin	
25	V _{CC1}	Supply voltage pin	
26	2nd mixer input	Input pin of the 2nd mixer circuit	
27	1st mixer output	Output pin of the 1st mixer circuit	
28	1st oscillator output	Output pin of the 1st oscillator	
29	1st oscillator tank	Tank coil connection pin	
30			
31	Variable cap control	Variable cap control pin	
32	1st mixer input	Input pin of the 1st mixer current	

■ 6932852 0013061 907 ■

■ Application Circuit

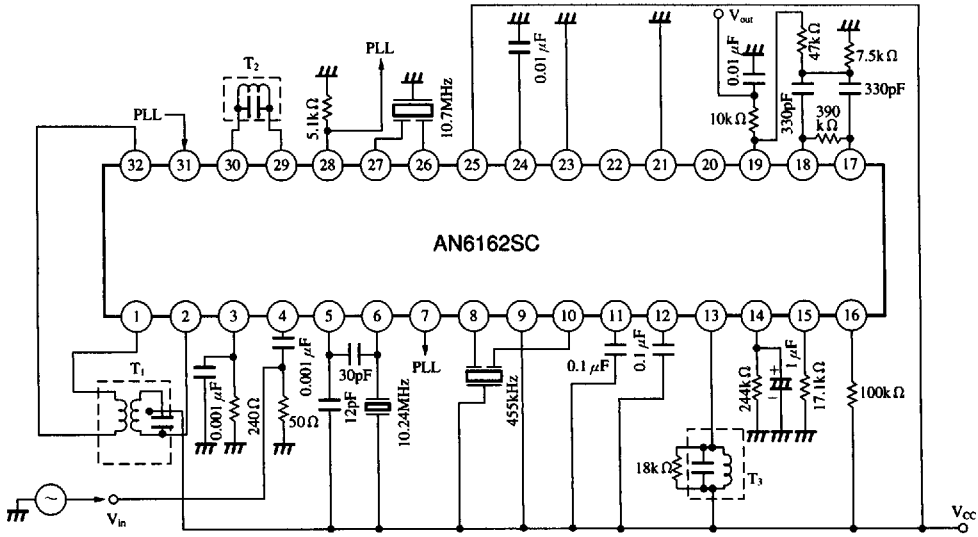

■ Characteristics Curve

$I_{CC} - V_{CC}$ Characteristics

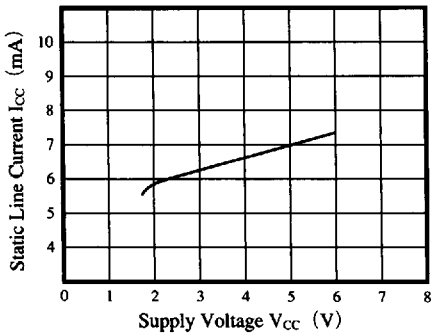

$V_O - V_{in}$ Characteristics

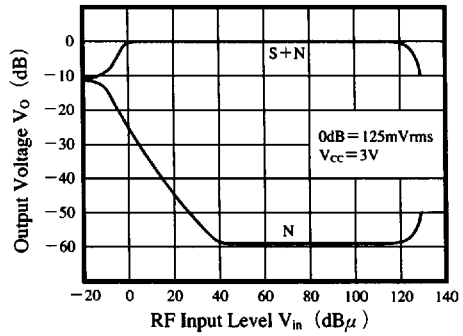

ICs for Telephone

■ 6932852 0013062 843 ■