

AN6096FHN

Transmission and reception IC for cellular telephone

■ Overview

The AN6096FHN is a transmission and reception IC for a cellular telephone. It is encapsulated in the QFN package which is very thin and very small outline by using our exclusive process method.

It integrates QPSK (Quadrature phase shift keying) modulator for transmission and an IF circuit for reception in a single chip. It contributes to realization of thinner and lighter equipment by adopting a very small package and designing a low power consumption circuit.

■ Features

- Integrating an orthogonal modulation circuit for transmission and an IF circuit for reception on a single chip
- Low power consumption by using an indirect modulation system in transmission block
- Built-in APC circuit for transmission output adjustment
- High input sensitivity by optimizing circuit in reception circuit
- Built-in RSSI circuit of wide dynamic range in reception block

■ Applications

- Cellular telephone

■ Block Diagram

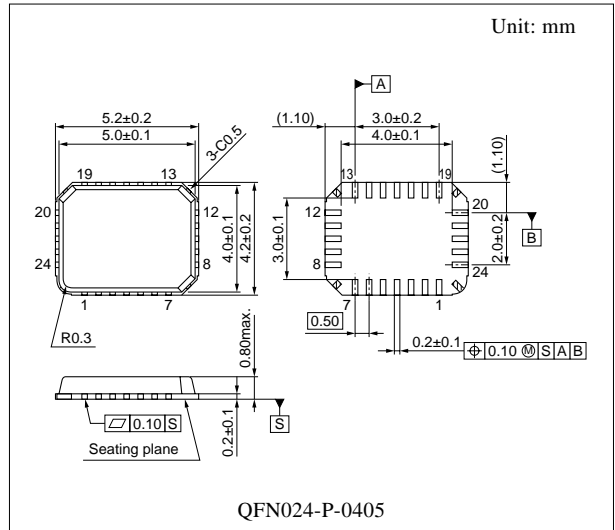
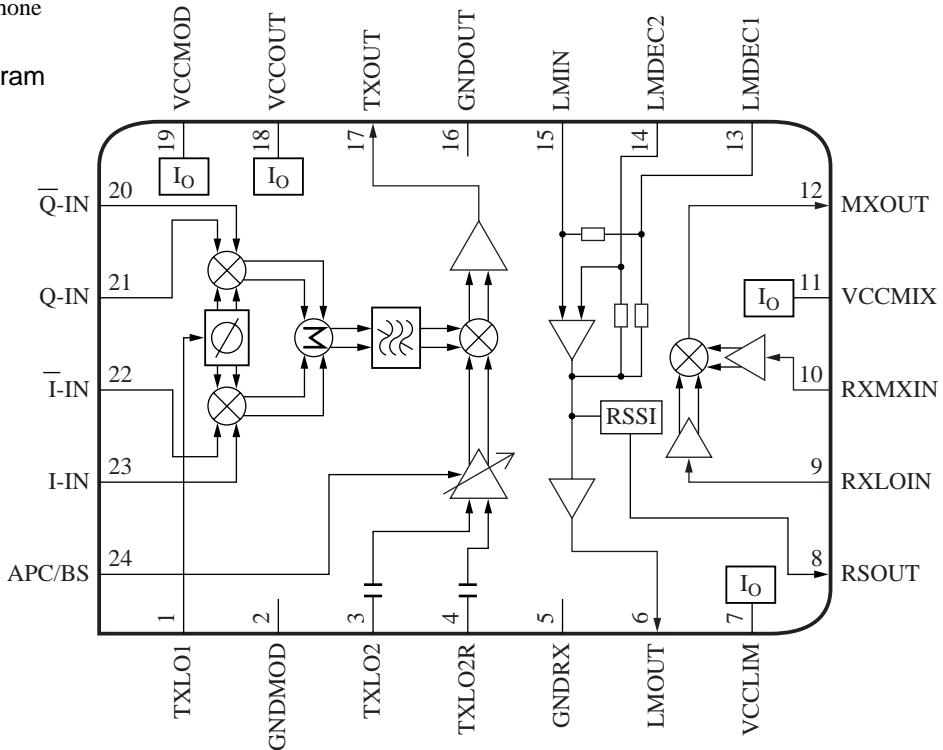

■ Pin Descriptions

| Pin No. | Symbol | Description | Pin No. | Symbol | Description |
|---------|--------|----------------------|---------|---------------|-------------------------|
| 1 | TXLO1 | TX local 1-in | 13 | LMDEC1 | Lim. decouple 1 |
| 2 | GNDMOD | GND TX-mod. | 14 | LMDEC2 | Lim. decouple 2 |
| 3 | TXLO2 | TX local 2 | 15 | LIMIN | Lim. in |
| 4 | TXLO2R | TX local 2-ref. | 16 | GNDOUT | GND TX-out |
| 5 | GNDRX | GND-RX | 17 | TXOUT | TX-output |
| 6 | LMOUT | Lim. out | 18 | VCCOUT | V _{CC} TX-out |
| 7 | VCCLIM | V _{CC} lim. | 19 | VCCMOD | V _{CC} TX-mod. |
| 8 | RSOUT | RSSI out | 20 | \bar{Q} -IN | \bar{Q} input |
| 9 | RXLOIN | RX local-in | 21 | Q-IN | Q input |
| 10 | RXMXIN | RX mix.-in | 22 | \bar{I} -IN | \bar{I} input |
| 11 | VCCMIX | V _{CC} mix. | 23 | I-IN | I input |
| 12 | MXOUT | Mix. out | 24 | APC / BS | APC / BS |

■ Absolute Maximum Ratings

| Parameter | Symbol | Rating | Unit |
|----------------------------------|------------------|-------------|------|
| Supply voltage | V _{CC} | 4.2 | V |
| Supply current | I _{CC} | 60 | mA |
| Power dissipation *2 | P _D | 125 | mW |
| Operating ambient temperature *1 | T _{opr} | -30 to +80 | °C |
| Storage temperature *1 | T _{stg} | -55 to +125 | °C |

Note) *1: Except for the operating ambient temperature and storage temperature, all ratings are for T_a = 25°C.

*2: The power dissipation shown is for the independent IC without a heat sink at T_a = 80°C. Refer to "■ Application Notes".

■ Recommended Operating Range

| Parameter | Symbol | Range | Unit |
|----------------|-----------------|------------|------|
| Supply voltage | V _{CC} | 2.7 to 4.0 | V |

■ Electrical Characteristics at $T_a = 25^\circ\text{C}$

| Parameter | Symbol | Conditions | Min | Typ | Max | Unit |
|--|------------------------|--|------|------|------|----------------|
| Consumption current *1 (Transmission) | I_{CCTX} | Lo1 = 178 MHz, -25 dBm Lo2 = 1 619 MHz, -20 dBm $V_{\text{APC}} = 2.3 \text{ V}$ | — | 25 | 33 | mA |
| Sleep current *1 | I_{SLTX} | No signal, $V_{\text{APC/BS}} = 0 \text{ V}$ | — | 0 | 10 | μA |
| Output level 1 *1 | P_{O1} | Lo1 = 178 MHz, -25 dBm Lo2 = 1 607 MHz, -20 dBm $V_{\text{APC}} = 2.3 \text{ V}$ | -16 | -13 | — | dBm |
| Output level 2 *1 | P_{O2} | Lo1 = 178 MHz, -25 dBm Lo2 = 1 631 MHz, -20 dBm $V_{\text{APC}} = 2.3 \text{ V}$ | -16 | -13 | — | dBm |
| Minimum output level *1 | P_{min} | Lo1 = 178 MHz, -25 dBm Lo2 = 1 619 MHz, -20 dBm $V_{\text{APC}} = 1.0 \text{ V}$ | — | -50 | -43 | dBm |
| Consumption current (Reception) *2 | I_{CCRX} | No signal | — | 3.2 | 4.5 | mA |
| Mix. conversion gain *2 | G_{MX} | $V_{\text{M1}} = 60 \text{ dB}\mu$, SW1 = b Filter loss: except for -5.5 dB | 21 | 23.5 | 26 | dB |
| Mix. maximum output amplitude *2 | V_{MX} | $V_{\text{M1}} = 105 \text{ dB}\mu$, SW1 = b Filter loss: except for -5.5 dB | 101 | 107 | — | $\text{dB}\mu$ |
| Lim. voltage gain *2 | G_{LM} | $V_{\text{L1}} = 15 \text{ dB}\mu$ | 80 | 85 | 90 | dB |
| Lim. maximum output amplitude *2 | V_{LM} | $V_{\text{L1}} = 80 \text{ dB}\mu$, 400 kHz component | 0.90 | 1.25 | 1.60 | V[p-p] |
| RSSI output voltage 1 *2 | V_{S1} | $V_{\text{L1}} = 0 \text{ dB}\mu$ | 0 | 0.23 | 0.6 | V |
| RSSI output voltage 2 *2 | V_{S2} | $V_{\text{L1}} = 115 \text{ dB}\mu$ | 2.31 | 2.6 | 2.91 | V |
| RSSI reference output inclination *3 | D_{S} | $V_{\text{S}} (V_{\text{IS}}) = V_{\text{S1}} + 0.12 \text{ V}$ $D_{\text{S}} = V_{\text{S}} (V_{\text{IS}} + 75 \text{ dB}\mu) - V(V_{\text{IS}})$ | 1.39 | 1.8 | 2.19 | V |
| RSSI output inclination variation 1 *3 | ΔD_{S1} | $\Delta D_{\text{S1}} = 5\{V_{\text{S}} (V_{\text{IS}} + 15 \text{ dB}\mu) - V_{\text{S}} (V_{\text{IS}})\} / D_{\text{S}}$ | 0.75 | 1 | 1.25 | — |
| RSSI output inclination variation 2 *3 | ΔD_{S2} | $\Delta D_{\text{S2}} = 5\{V_{\text{S}} (V_{\text{IS}} + 30 \text{ dB}\mu) - V_{\text{S}} (V_{\text{IS}} + 15 \text{ dB}\mu)\} / D_{\text{S}}$ | 0.75 | 1 | 1.25 | — |
| RSSI output inclination variation 3 *3 | ΔD_{S3} | $\Delta D_{\text{S3}} = 5\{V_{\text{S}} (V_{\text{IS}} + 45 \text{ dB}\mu) - V_{\text{S}} (V_{\text{IS}} + 30 \text{ dB}\mu)\} / D_{\text{S}}$ | 0.75 | 1 | 1.25 | — |
| RSSI output inclination variation 4 *3 | ΔD_{S4} | $\Delta D_{\text{S4}} = 5\{V_{\text{S}} (V_{\text{IS}} + 60 \text{ dB}\mu) - V_{\text{S}} (V_{\text{IS}} + 45 \text{ dB}\mu)\} / D_{\text{S}}$ | 0.75 | 1 | 1.25 | — |
| RSSI output inclination variation 5 *3 | ΔD_{S5} | $\Delta D_{\text{S5}} = 5\{V_{\text{S}} (V_{\text{IS}} + 75 \text{ dB}\mu) - V_{\text{S}} (V_{\text{IS}} + 60 \text{ dB}\mu)\} / D_{\text{S}}$ | 0.75 | 1 | 1.25 | — |

Note) *1: $V_{\text{CC}} = 3.0 \text{ V}$, IQ signal amplitude: 0.35 V[p-p] (single phase), DC bias: 1.6 V , $\pi/4$ QPSK modulation wave

Output frequency of P_{O1} : 1 429.002 5 MHz, Output frequency of P_{O2} : 1 453.002 5 MHz,

Output frequency of P_{min} : 1 441.002 5 MHz

Lo input level is a setting value of signal source (output impedance 50Ω).

*2: $V_{\text{CC2}} = 3.0 \text{ V}$, SW1 = a, $V_{\text{LO3}} = 90 \text{ dB}\mu$; $f = 129.6 \text{ MHz}$, V_{M1} : $f = 130 \text{ MHz}$, V_{L1} : $f = 400 \text{ kHz}$ (input level of pin 15 excluding the attenuation by matching circuit and filter.) V_{MX} and V_{LM} are measured in high impedance unless otherwise specified.

Lo input level is a setting value of signal source (output impedance 50Ω).

*3: V_{IS} is the input level of which the RSSI output voltage becomes $V_{\text{S1}} + 0.12 \text{ V}$.

■ Electrical Characteristics at $T_a = 25^\circ\text{C}$ (continued)

• Design reference data

Note) The characteristics listed below are theoretical values based on the IC design and are not guaranteed.

$V_{CC1} = 3.0\text{ V}$ unless otherwise specified.

Lo input level is a setting value of signal source (output impedance 50 Ω).

| Parameter | Symbol | Conditions | Min | Typ | Max | Unit |
|---|------------|--|------|-----|------|------|
| Carrier leak suppression amount ($f_{LO2} - f_{LO1}$) | CL | Lo1 = 178 MHz, -25 dBm Lo2 = 1 619 MHz, -20 dBm $V_{APC} = 2.3\text{ V}$ IO: DC offset adjustment | — | -35 | — | dBc |
| Image leak suppression amount | IL | Lo1 = 178 MHz, -25 dBm Lo2 = 1 619 MHz, -20 dBm $V_{APC} = 2.3\text{ V}$, IO: level adjustment | — | -35 | — | dBc |
| Near spurious suppression amount | DU | Lo1 = 178 MHz, -25 dBm Lo2 = 1 619 MHz, -20 dBm $V_{APC} = 2.3\text{ V}$ | — | -70 | -65 | dBc |
| Base band distortion suppression amount | BD | Lo1 = 178 MHz, -25 dBm Lo2 = 1 619 MHz, -20 dBm $V_{APC} = 2.3\text{ V}$ | — | -40 | — | dBc |
| Adjacent channel leakage power suppression amount (30 kHz detuning) | BL1 | Lo1 = 178 MHz, -25 dBm Lo2 = 1 619 MHz, -20 dBm $V_{APC} = 2.3\text{ V}$ | — | -45 | -38 | dBc |
| Adjacent channel leakage power suppression amount (50 kHz detuning) | BL2 | Lo1 = 178 MHz, -25 dBm Lo2 = 1 619 MHz, -20 dBm $V_{APC} = 2.3\text{ V}$ | — | -70 | -60 | dBc |
| Adjacent channel leakage power suppression amount (100 kHz detuning) | BL3 | Lo1 = 178 MHz, -25 dBm Lo2 = 1 619 MHz, -20 dBm $V_{APC} = 2.3\text{ V}$ | — | — | -65 | dBc |
| APC variable width | L_{APC} | Lo1 = 178 MHz, -25 dBm Lo2 = 1 619 MHz, -20 dBm $V_{APC} = 1.0\text{ V to } 2.3\text{ V}$ | 30 | 37 | — | dB |
| APC output level control sensitivity | S_{APC} | Lo1 = 178 MHz, -25 dBm Lo2 = 1 619 MHz, -20 dBm $V_{APC} = 1.0\text{ V / } 1.6\text{ V}$ | — | 46 | — | dB/V |
| In-band output level deviation | ΔP | Lo1 = 178 MHz, -25 dBm Lo2 = 1 607 MHz to 1 631 MHz, -20 dBm $V_{APC} = 2.3\text{ V}$ | -1.5 | — | +1.5 | dB |
| Modulation precision | EVM | Lo1 = 178 MHz, -25 dBm Lo2 = 1 619 MHz, -20 dBm $V_{APC} = 2.3\text{ V}$ | — | 2.0 | — | %rms |

■ Application Notes

- P_D — T_a curves of QFN024-P-0405

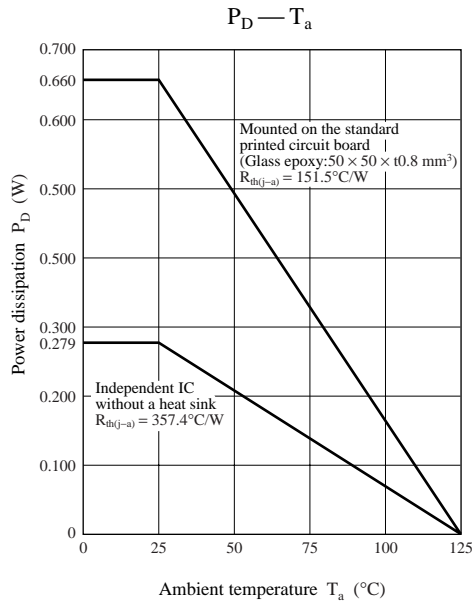

• Main characteristics

Note) Test conditions are the same as "■ Electrical Characteristics" unless otherwise specified.

The characteristics listed below are theoretical values based on the IC design and are not guaranteed.

APC control voltage characteristics

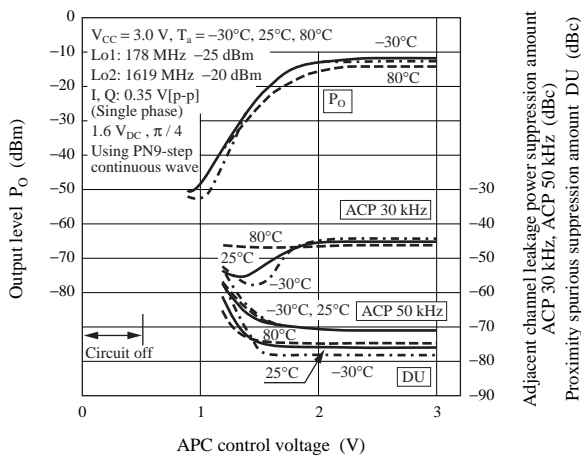

Mix. characteristics

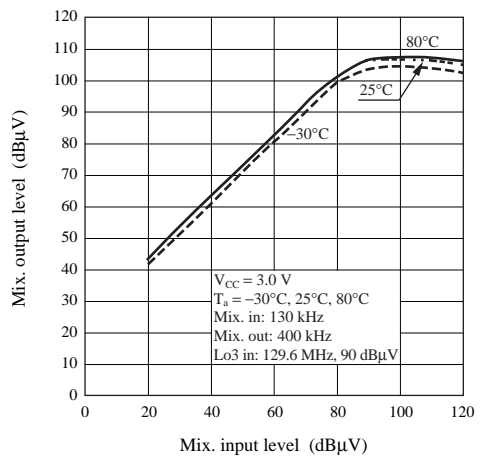

■ Application Notes (continued)

• Main characteristics (continued)

Note) Test conditions are the same as "■ Electrical Characteristics" unless otherwise specified.

The characteristic values below are theoretical values for designing and not guaranteed.

Proximity spurious suppression

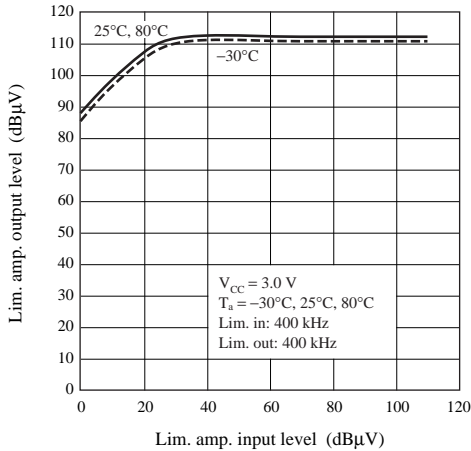

RSSI characteristics

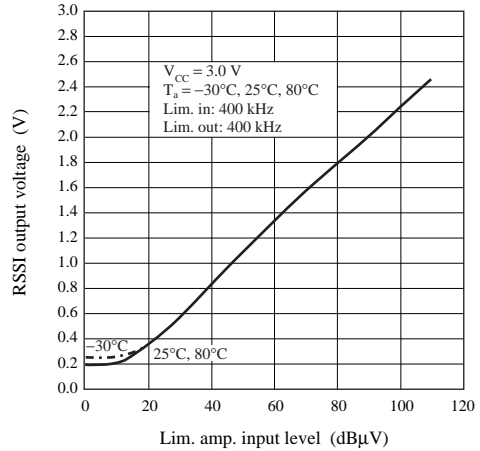

■ Application Circuit Example

