

AN5337K

NTSC Video Signal Processor IC

■ Overview

The AN5337K is suitable for processing of video, chroma, RGB, synchronization, and deflection signals of NTSC system. It incorporates an I²C bus controller.

■ Features

- Video : Wide bandwidth filter, adjustable preshoot and overshoot, adjustable aperture control, ABL input
- Chroma : ACC filter, color difference output
- RGB : Color difference input, RGB output
- Synchronization : Synchronous BLK input/output, adjustable AFC1 time-constant, adjustable horizontal center
- Deflection : Generation of parabola waves and saw-tooth waves, distortion correction

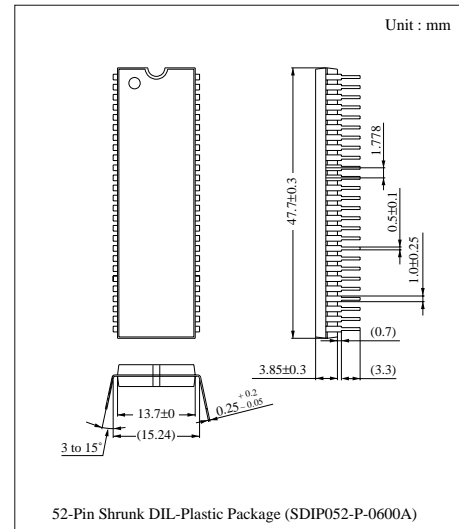

■ Block Diagram

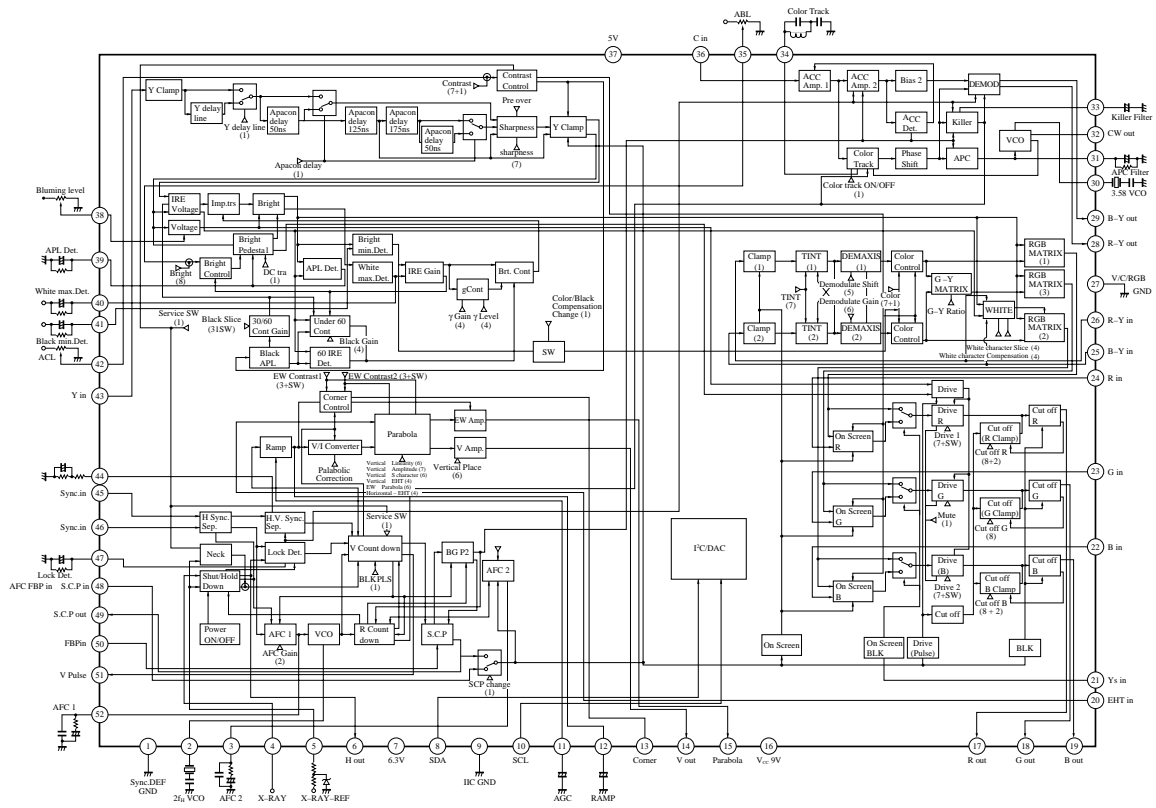

■ Pin Descriptions

Pin No.	Pin name	Pin No.	Pin name
1	Sync. Def GND	27	V/C/RGB GND
2	503kHz VCO	28	R –Y output
3	AFC2 filter	29	B –Y output
4	High voltage det. input (X–ray)	30	3.58MHz VCO
5	High voltage det. ref. voltage	31	Chroma APC filter
6	Horizontal drive pulse output	32	VCO output
7	Horizontal power supply (HV _{CC})	33	Killer filter
8	I ² C SDA input	34	Color track filter
9	I ² C GND	35	ABL input
10	I ² C SCL input	36	Chroma input
11	Reference ramp waveform AGC	37	5V power supply (V _{CC2})
12	Reference ramp waveform generation	38	Blooming level input
13	Corner slice level	39	Filter for APL detection
14	Ver. deflection saw-tooth output	40	Filter for white detection
15	EW output	41	Black det. filter/color control
16	9V power supply (V _{CC1})	42	ACL input
17	R output	43	Y signal input
18	G output	44	V sync. sep filter
19	B output	45	H sync. input
20	EHT voltage detection	46	V sync. input
21	Ys input	47	Lock det. filter
22	On-screen B input	48	Sand castle pulse input/FBP input for AFC
23	On-screen G input	49	Sand castle pulse output
24	On-screen R input	50	Flyback pulse (FBP) input for BLK
25	B –Y input	51	V pulse output
26	R –Y input	52	AFC1 filter

■ Absolute Maximum Ratings

Parameter	Symbol	Rating	Unit
Supply voltage	V _{CC1}	9.6	V
	V _{CC2}	5.6	
Supply current	I _{CC1} (I ₁₆)	113	mA
	I _{CC2} (I ₃₇)	89	
	I ₇	26	
Power dissipation ^{Note 2)}	P _D	1481	mW
Operating ambient temperature ^{Note 1)}	T _{opr}	–20 to + 70	°C
Storage temperature ^{Note 1)}	T _{stg}	–55 to +150	°C

Note 1) T_a = 25°C except operating ambient temperature and storage temperature.

Note 2) Allowable power dissipation of the package at T_a = 70°C.

■ Recommended Operating Range (T_a = 25°C)

Parameter	Symbol	Range
Operating supply voltage range	V _{CC1} V _{16-1, 9, 27}	8.5V to 9.0V to 9.5V
	V _{CC2} V _{37-1, 9, 27}	4.5V to 5.0V to 5.5V
Operating supply current range	I ₇	15mA to 20mA to 25mA

■ Electrical Characteristics (Ta= 25±2°C)

Parameter	Symbol	Condition	min	typ	max	Unit
DC Characteristics						
Circuit current	I ₁₆	V _{CC1} : 9V, V _{CC2} : 5V Pin7 with 380Ω 12V	74	90	106	mA
Circuit current	I ₃₇	V _{CC1} : 9V, V _{CC2} : 5V Pin7 with 380Ω 12V	59	71	83	mA
Synchronous input terminal voltage	V ₄₅₋₁	V _{CC1} : 9V, V _{CC2} : 5V Pin7 with 380Ω 12V	0.8	1.3	1.8	V
Synchronous input terminal voltage	V ₄₆₋₁	V _{CC1} : 9V, V _{CC2} : 5V Pin7 with 380Ω 12V	0.8	1.3	1.8	V
Video input terminal voltage	V ₄₃₋₂₇	V _{CC1} : 9V, V _{CC2} : 5V Pin7 with 380Ω 12V	2.7	3.2	3.7	V
ABL input terminal voltage	V ₃₅₋₂₇	V _{CC1} : 9V, V _{CC2} : 5V Pin7 with 380Ω 12V	2.5	3.0	3.5	V
ACL input terminal voltage	V ₄₂₋₂₇	V _{CC1} : 9V, V _{CC2} : 5V Pin7 with 380Ω 12V	2.5	3.0	3.5	V
Blooming level terminal voltage	V ₃₈₋₂₇	V _{CC1} : 9V, V _{CC2} : 5V Pin7 with 380Ω 12V	2.2	2.7	3.2	V
Chroma input terminal voltage	V ₃₆₋₂₇	V _{CC1} : 9V, V _{CC2} : 5V Pin7 with 380Ω 12V	1.5	2.0	2.5	V
B-Y output terminal voltage	V ₂₉₋₂₇	V _{CC1} : 9V, V _{CC2} : 5V Pin7 with 380Ω 12V	2.3	2.8	3.3	V
R-Y output terminal voltage	V ₂₈₋₂₇	V _{CC1} : 9V, V _{CC2} : 5V Pin7 with 380Ω 12V	2.3	2.8	3.3	V
Horizontal Signal Processing						
Horizontal stabilized supply voltage	HV _{CC}	V _{CC1} : 9V, V _{CC2} : 5V Pin7 with 380Ω 12V	5.9	6.3	6.7	V
Constant voltage operation resistor	RHV _{CC}	I ₇ · 15 to 25mA	—	—	30	Ω
Horizontal free-run oscillation frequency (1)	f _{HO-1}		15.45	15.75	16.05	kHz
f _{HO} variation to rising power supply	$\frac{\Delta f_{HO}}{V_{CC3}}$	f _{HO} frequency difference when other supply OFF→ON	0	100	200	Hz
Horizontal output pulse duty	τ _{HO}		34.4	37.5	40.6	%
Horizontal output starting voltage	V _{FH(S)}	f=10k to 20kHz when horizontal oscillation output is more than 1V _{P-P}	—	—	5.2	V
Horizontal output level	V _{FH}		2.4	2.9	3.4	V
Horizontal pull-in range	f _{PH}	f _{HO} =15.73kHz	±400	—	—	Hz
H center variable range (1)	T _{DH}	Phase lead at 1A[10]→[00]	1.8	2.5	3.2	μs
H center variable range (2)	T _{DH}	Phase lead at 1A[10]→[1F]	-3.0	-2.3	-1.6	μs
Lock detector output voltage (1)	V _{47-M}	Synchronized	5.1	5.8	6.5	V
Lock detector output voltage (2)	V _{47-L}	Not synchronized	-0.1	0	0.5	V
Lock detector output voltage (3)	V _{47-T}	Shut down	7.6	8.3	9.0	V
Shut-down operation voltage	V _{Hth}	V _{ref} (= Pin5) = 6.2V	2.65	2.8	2.95	V
Burst gate pulse width	T _{BGP}	Sandcastle pulse output	1.8	2.5	3.2	μs
Sandcastle pulse output level (BGP)	V _{BGP}	V _{CC} : typ.	4.0	4.3	4.6	v
Sandcastle pulse output level (HBLK)	V _{HBLK}	V _{CC} : typ.	2.7	3	3.3	v
Sandcastle pulse output level (VBLK)	V _{VBLK}	V _{CC} : typ.	1.2	1.5	1.8	v
Vertical Signal Processing						
Vertical output pulse width	τ _{VO}		360	380	400	μs
Vertical output level	V _{51H}		1.3	1.8	2.3	V
Vertical output free-run frequency	f _{VO}		58.8	60	61.2	Hz
Vertical blanking pulse width	τ _{VBLK}		1.09	1.12	1.15	ms

Electrical Characteristics (cont.) (Ta= 25±2°C)

Parameter	Symbol	Condition	min	typ	max	Unit
Y Signal Processing						
Video voltage gain	AY _G	Cont : max. Sharp : min.	17	20	23	dB
Video voltage gain relative ratio	AY	Ratio between channels Drive : typ.	-2.5	0	2.5	dB
Video voltage gain relative ratio DL	AY _{Gd1}	Y delay line ON/OFF	-1.5	0	1.5	dB
Sharpness 1	AG _{(SH)1}	f=4MHz, aper. con. SW : 00	11.5	14.5	17.5	dB
Sharpness 2	AG _{(SH)2}	f=3MHz, aper. con. SW : 02	11.5	14.5	17.5	dB
Contrast control range max.	AG _(CON)	Sharp : min. Cont : typ.	3.5	6	8.5	dB
Contrast control min. value	YG _{(CON)min.}	Contrast : min.	—	30	200	mV
Brightness variable range	V _{BR}	No input, Bright : min.→max.	3.0	3.7	4.4	V
DC restoration rate 1	TDC1	APL10→90% DC transmission range : - direction	90	96	102	%
DC restoration rate 2	TDC2	APL10→90% DC transmission range : + direction	96	103	110	%
Y signal delay time 1	τ _{DL1}	Y delay line : ON	260	325	390	ns
Y signal delay time 2	τ _{DL2}	Y delay line : OFF	160	205	250	ns
Y frequency characteristics 1	Δy ₁ (Y)	10MHz attenuation range DL for f=3MHz : ON	-6	-3	+1	dB
Y frequency characteristics 2	Δy ₂ (Y)	10MHz attenuation range DL for f=3MHz : OFF	-5	-2	+2	dB
ACL characteristics	Δy _{ACL}	Pin42 3V→3.5V	8	11	14	dB/V
ABL characteristics	ΔY _{ABL}	Pin35 2.7→3.5V	2.7	3.4	4.1	V/V
Black extention range	ΔYBL1	Input : full black, Pin41 : 5V→ CR filter	-0.1	0	0.1	V
Black extention gain	ΔYBL2	Input : full black, Pin41 : 3V Black gain : min.→max.	1.6	1.95	2.3	V
Black extention start point	ΔYBL3	Pin41 : 5V, adjust Y output to 2.7V _{P-P} by contrast, after that connect Pin45 to CR filter.	-0.12	0	0.12	V
Black extention range	ΔYBL4	Black level : min. Adjust output 0.8V _{P-P} by contrast. After that make black level be maximum.	0.08	0.18	0.28	V
g correction range min. to max.	Y _γ	White γ gains : max. White γ level : min. to max.	0.5	0.85	1.2	V
Blooming level variation range	ΔYBLM	Blooming DCPin38 : 0.5V→4.5V	3.2	3.9	4.6	V
Pedestal level (standard)	Y _G	Cut-off : 80	2.0	2.4	2.8	V
Chroma Signal Processing						
ACC characteristics 1	ACC1	Color bar signal (burst 300mV _{P-P})	-1	0	+1	dB
ACC characteristics 2	ACC2	Color bar signal (burst 18mV _{P-P})	-4	-1.5	+1	dB
Killer tolerance	e _k	Color bar burst 0dB=150mV _{P-P}	-48	-43	-38	dB
Killer tolerance hysteresis	e _k	Color bar signal burst 0dB=150mV _{P-P}	—	+2	+4	dB
Demodulation output amplitude B-Y	e _{OB}	Color bar signal (burst 150mV _{P-P})	1.04	1.34	1.64	V _{P-P}
Demodulation output amplitude R-Y	e _{OR}	Color bar signal (burst 150mV _{P-P})	0.82	1.07	1.32	V _{P-P}
Demodulation output ratio	R/B	Rainbow signal R-Y/B-Y output ratio	0.48	0.56	0.64	times

■ Electrical Characteristics (cont.) (Ta= 25±2°C)

Parameter	Symbol	Condition	min	typ	max	Unit
Demodulation angle B-Y	$\angle B$		-5	0	5	degree
Demodulation angle R-Y	$\angle R$		83	88	93	degree
Color residue	e_{killer}	Killer filter terminal grounded by 20k Ω	—	—	50	mV _{P-P}
Demodulation output residual carrier	e_{car}	No signal input	—	—	50	mV _{P-P}
APC pull-in range Low	f_{pull}	Burst frequency variation	500	600	—	Hz
APC pull-in range High	f_{pull}	Burst frequency variation	-500	-600	—	Hz
CW output amplitude	e_{cw}		600	800	1100	mV _{P-P}
Free-run frequency	f_{co}	Shift from 3.579545MHz	-200	0	200	Hz
RGB Signal Processing						
Tint center	θ_t	Pin25 356mV _{P-P} Pin26 200mV _{P-P} DAC value where R,B outputs are coincident	[2F]	[3A]	[4A]	—
Tint variable range max. *	$\Delta\theta_1$	Tint : typ.→max.	40	65	—	degree
Tint variable range min. *	$\Delta\theta_2$	Tint : typ.→min.	-37	-50	—	degree
R-Y demodulation axis variable range *	$\Delta\theta_{\text{Dem}}$	Demodulation axis : min.→max.	16	28	39	degree
B-Y ratio variable range (1) *	AB-Y min.	Demodulation ratio : typ.→min.	—	0	0.25	times
B-Y ratio variable range (2) *	AB-Y min.	Demodulation ratio : typ.→max.	1.25	1.5	1.75	times
G-Y/R-Y ratio (1) *	e_G/e_{R2}	G-Y ratio change-over : 02	0.23	0.3	0.37	times
G-Y/R-Y ratio (2) *	e_G/e_{R1}	G-Y ratio change-over : 01	0.37	0.47	0.57	times
G-Y/B-Y ratio (1) *	e_G/e_{B2}	G-Y ratio change-over : 02	0.12	0.2	0.28	times
G-Y/B-Y ratio (2) *	e_G/e_{B1}	G-Y ratio change-over : 01	0.18	0.27	0.36	times
RGB output blanking voltage	E_{BLK}	Bright : typ. cut-off	0.7	1.1	1.5	V
Color control range max. *	A_{B-YCl} max.	Cont : typ. Color : typ.→max.	3.4	5.0	6.6	dB
Color control min. value *	A_{B-YCl} min.	Cont : typ. Color : typ.→max.	—	25	50	mV
Color difference contrast variable range *	$A_{B(\text{CON})}$	Cont : typ. Color : typ.→min.	3.5	6	8.5	dB
Drive control range	$A_{R(\text{DR})}$	Drive SW : 00→04 Drive : min.→max.	4	6	8	dB
Cut-off R · B control range	$V_{(\text{CO})}$	Cut off SW Cut off : min.→max.	1.6	2.1	2.6	V
Cut-off G control range	$V_{(\text{CO})G}$	Cut-off min. to max.	0.6	1.1	1.6	V
On-screen voltage gain	A_{yG}	Ys=1V Contrast ; max.	8	10	12	dB
On-screen contrast range	$A_{yG(\text{ON})}$	Ys=1V typ.→max.	0	1.5	3.5	dB
On-screen contrast min. value	$A_{yG(\text{ON})}$ min.	0.5V input	0.1	0.3	0.5	V _{P-P}
On-screen frequency characteristics	Δe	Attenuation quantity at f=10MHz to f=3MHz	-6	-3	+1	dB
Deflection Signal Processing						
Standard vertical output amplitude	V_{out}		2.2	2.6	3.0	V _{P-P}
Standard EW output amplitude	V_{EW}		1.8	2.2	2.6	V _{P-P}
Horizontal Signal Processing						
Separable sync. signal	V_{IN}	Input : full black sync. level	(0.2)	(1.0)	—	V _{P-P}
f_{HO} ambient temperature dependency	$\frac{\Delta f_{\text{HO}}}{T_a}$	Ta= -20 to + 70°C	—	(5.5)	—	Hz/°C
Horizontal oscillation frequency control sensitivity	b_{H}		—	(1.2)	—	Hz/mV
AFC1 reference current (1)	$I_{30(1)}$	0D [30]	—	(0.83)	—	mA

Note) The characteristics value in parentheses is not a guaranteed value, but reference one on design.

* The state in which R, B amplitudes and G amplitude are made coincident, is come out by means of drive I, II adjustments where Y signal is inserted to Pin17.

■ Electrical Characteristics (cont.) (Ta= 25±2°C)

Parameter	Symbol	Condition	min	typ	max	Unit
AFC1 reference current (2)	I _{30 (2)}	0D [20]	—	(1.33)	—	mA
AFC1 reference current (3)	I _{30 (3)}	0D [10]	—	(1.83)	—	mA
AFC1 reference current (4)	I _{30 (4)}	0D [00]	—	(2.33)	—	mA
F.B.P slice level (blanking)	V _{FBP-1}		—	(0.7)	—	V
F.B.P slice level (AFCI)	V _{FBP-2}		—	(2.5)	—	V
F.B.P delay time range	T _{H-FBP}	H center : typ. Hout rise to FBP center	—	—	(19)	μs
B.G.P start position	—	Horizontal sync. rear edge to Burst gate pulse front edge	—	(0.3)	—	μs
Sandcastle pulse output temperature characteristics	ΔV _{49 (Ta)}		—	(1.8)	—	mV/deg
Sandcastle pulse input threshold level temperature characteristics	ΔV _{48 (Ta)}		—	(0)	—	mV/deg
FBP input threshold level temperature characteristics HBLK	ΔV _{50 (Ta)}		—	(-1.8)	—	mV/deg
FBP input threshold level temperature characteristics AFCI	—		—	(1)	—	mV/deg
X-ray inner reference temperature characteristics	—	Zener temperature characteristics +1.8mV/deg	—	(0)	—	mV/deg
Sandcastle pulse output supply voltage dependency BGP	—	V _{CC2} 5V±0.5V	—	(1)	—	V/V
Sandcastle pulse output supply voltage dependency HBLK	—	V _{CC2} 5V±0.5V	—	(0.74)	—	V/V
Sandcastle pulse output supply voltage dependency VBLK	—	V _{CC2} 5V±0.5V	—	(0.44)	—	V/V

Vertical Signal Processing

Vertical BLK phase (WIDE)	PVBLK (W)	Period from VBLK rise up to vertical sync. fall down	—	(3.87)	—	ms
Vertical BLK phase (NORMAL)	PVBLK	Period from VBLK rise up to vertical sync. fall down	—	(0.2)	—	ms
Neck break operation Pin49 voltage	V ₄₉	Pin5 : 1.5V	(1.5)	—	—	V
Vertical BLK pulse width (WIDE)	TVBLK (W)		—	(5.05)	—	ms

Y Signal Processing

Contrast variable range	A _{yG (CON)} min.	Contrast : 00 to 7F	—	(40)	—	dB
Y output amplitude V _{CC} dependency	Δy _{G (V_{CC})}		—	(0.4)	—	dB/V
Y output DC voltage V _{CC} dependency	ΔY _{G (V_{CC})}		—	(0.18)	—	V/V
Y noise level	V _{YNL}		—	(7)	(50)	mV
Delay line dynamic range	V _{DLmax}		—	(0.7)	—	V
Y output amplitude ambient temperature dependency R	Δy _{R (Ta)}	-20 to +70°C	—	(-6)	—	%
Y output amplitude ambient temperature dependency G	Δy _{G (Ta)}	-20 to +70°C	—	(-8)	—	%
Y output amplitude ambient temperature dependency B	Δy _{B (Ta)}	-20 to +70°C	—	(-6)	—	%
APL detection voltage	A _{APL}	APL 50→100% detection voltage ratio	(1)	(2)	(4)	times

Chroma Signal Processing

Demodulation output amplitude V _{CC} dependency	e ₀ -V		—	(0)	—	dB/V
VCO V _{CC} dependency	Δf _{CO} -V		—	(220)	—	Hz/V
Burst-chroma ratio tolerance	Δe ₀ (bst)	Burst compression tolerance for color bar chroma	—	(-40)	—	%
Demodulation output ambient temperature dependency R-Y	Δe _{R-Y (Ta)}	-20 to +70°C	—	(-3)	—	%
Demodulation output ambient temperature dependency B-Y	Δe _{B-Y (Ta)}	-20 to +70°C	—	(-3)	—	%

Note) The characteristics value in parentheses is not a guaranteed value, but reference one on design.

■ Electrical Characteristics (cont.) (Ta= 25±2°C)

Parameter	Symbol	Condition	min	typ	max	Unit
RGB Signal Processing						
Y→RGB crosstalk	e _{CT1}	Crosshatch	—	(-45)	—	dB
RGB→Y crosstalk	e _{CT2}	Crosshatch	—	(-40)	—	dB
Color difference input dynamic range	AV _{max.}		—	(2.2)	—	V
Internal external pedestal difference voltage	ΔE _(YS)		(-100)	(0)	(100)	mV
OSD input dynamic range	AV _{max.}		—	(1.5)	—	V
RGB output amplitude V _{CC} dependency	Δe _G (V _{CC})	V _{CC1} 8.5 to 9.5V V _{CC2} 4.5 to 5.5V	—	(0.4)	—	V/V
OSD output amplitude V _{CC} dependency	Δe _g (V _{CC})	V _{CC1} 8.5 to 9.5V V _{CC2} 4.5 to 5.5V	—	(0)	—	V/V
RGB color difference amplitude temperature dependency	Δe _G (Ta)	-20 to +70°C	—	(20)	—	%
OSD output amplitude temperature dependency	Δe _g (Ta)	-20 to +70°C	—	(6)	—	%
Color control range (External)	Δe _{color}	∅E : [40] Control ratio to DAC	—	(28)	—	%
White character slice level range	V _W	Blooming DC2.5V Color difference no input	(0.6)	(0.8)	(1.0)	V
White character correction range	ΔV _W	Blooming DC2.5V Color difference no input	(0.6)	(0.8)	(1.0)	V
C/Y ratio	V _{CY}	Y : 0.36VB -W C : Color bar standard Color : typ. Contrast : typ. G-Y/Y zero peak ratio at G output	(0.23)	(0.36)	(0.56)	times
Pedestal variation at OSD contrast	ΔE _(cont)	YsL, YsH (BLK period low) output DC difference Contrast : 1E - max.	(-200)	(0)	(200)	mV
R-Y/B-Y ratio	e _R /e _B	Pin25 ; 356mV _{P-P} Pin26 ; 200mV _{P-P}	—	—	(1.0)	times
Color track OFF/ON * variation (1) Blue	Δe _{BB}	B -Y1.39V, R-Y1.1V, After tint and color adjustment	(-160)	(0)	(160)	mV
Color track OFF/ON * variation (2) Red	Δe _{BR}	Color track ON Variation quantity at ∅E : 03→04	(-240)	(-40)	(-160)	mV
Color track OFF/ON * variation (3) Yellow	Δe _{RY}		(-350)	(-200)	(-16)	mV
Deflection Signal Processing						
Vertical amplitude variation ratio	ΔV _{amp}	Vertical amplitude typ.→max., min.	(-15)	(±22)	(±30)	%
Vertical linearity variation width	ΔV _{lin}	Vertical linearity : typ.→max., min.	(±8)	(±12)	(±19)	%
Vertical S-correction amplitude variation ratio	ΔV _{sc}	Vertical S correction : max.→min.	(-33)	(-19)	(-5)	%
Vertical position variation width	ΔV _{shift}	Vertical position : min.→max.	(0.6)	(0.8)	(-1.0)	V
Vertical EHT correction amplitude variation ratio	ΔV _{EHT}	Pin62= 0V, Vertical EHT : typ.→max., min.	(±7)	(±11)	(±15)	%
EW parabola variation width	ΔV _{parabola}	EW parabola amplitude : min.→max.	(2.8)	(4.1)	(5.4)	V _{P-P}
Horizontal amplitude variation width	ΔV _{H-WIDTH}	Horizontal amplitude min.→max.	(3.4)	(4.6)	(5.8)	V
Horizontal amplitude MIN DC value	V _{H-WIDTH}		(1.5)	(1.9)	(2.3)	V
Trapezoidal distortion correction variation ratio	ΔV _{Trapz}	Trapezoidal distortion correction : typ.→max., min.	(±48)	(±72)	(±96)	%
Corner correction variation ratio 1	ΔV _{corner}	EW corner-1 : min.→max.	(-40)	(-28)	(-16)	%
Corner correction variation ratio 2	ΔV _{corner}	EW corner-2 : min.→max.	(-38)	(-26)	(-14)	%

Note) The characteristics value in parentheses is not a guaranteed value, but reference one on design.

* The state in which R, B amplitudes and G amplitude are made coincident, is come out by means of drive I, II adjustments where Y signal is inserted to Pin17.

■ Electrical Characteristics (cont.) (Ta= 25±2°C)

Parameter	Symbol	Condition	min	typ	max	Unit
Horizontal EHT correction variable range	ΔV_{H-EHT}	Pin20 =1V Horizontal EHT : min.→max.	(1.4)	(2.2)	(3.0)	V
Horizontal EHT correction MIN DC value	V_{H-EHT}		(1.8)	(2.8)	(3.8)	V
EW output V_{CC} variation	$\Delta V_{EW}(V_{CC})$	V_{CC1} 8.5 to 9.5V V_{CC2} 4.5 to 5.5V	—	(0)	—	%
EW amp. drive current	I_{EW-dr}		—	(1.4)	—	mA
Ramp wave form (NORMAL)	ΔV_{ramp}	0D [00]	—	(2.5)	—	V_{P-P}
Ramp wave form (WIDE)	$\Delta V_{ramp}(w)$	0D [40]	—	(2.5)	—	V_{P-P}
AGC input output current	I_{11}	Service SW : ON Pin12 sweep	—	(±140)	—	μA
Ramp input output current (1)	I_{12}	Pin11 : 1.5V, Pin49 : 2.5V Vpulse : ON	—	(4.4)	—	mA
Ramp input output current (2)	I_{12}	Pin11 : 1.5V, Pin12 : 2.5V Vpulse : OFF	—	(-90)	—	μA
Lateral line voltage ramp terminal voltage	V_{12-SW}	0D [80]	—	(1.2)	—	V
Input Signal						
Chroma input tolerant level	e_c in	Color bar chroma 330mV _{P-P} , burst level	(90)	(150)	—	mV _{P-P}
Y input tolerant level	y in	Sync. to white 100%	—	(0.5)	(0.7)	V_{P-P}
H Sync. input tolerant level	v_H in	Sync. to white 100%	(0.5)	(1.0)	(2.0)	V_{P-P}
V Sync. input tolerant level	v_V in	Sync. to white 100%	(0.5)	(1.0)	(2.0)	V_{P-P}
Sandcastle pulse external input BGP	V_{BGP} in	V_{CC} : typ.	(4.0)	(4.3)	(4.6)	V_{P-P}
Sandcastle pulse external input HBLK	V_{HBLK} in	V_{CC} : typ.	(2.7)	(3.0)	(3.3)	V_{P-P}
Sandcastle pulse external input VBLK	V_{VBLK} in	V_{CC} : typ.	(1.2)	(1.6)	(1.8)	V_{P-P}
FBP input (Pin48, 50)	V_{FBP} in	V_{CC} : typ.	—	—	(3.5)	V
Ys input threshold voltage	V_{21}	V_{CC} : typ.	(0.4)	(0.7)	(1.2)	V
On-screen input R	e_{24}		—	(0.71)	(1.0)	V_{P-P}
On-screen input G	e_{23}		—	(0.71)	(1.0)	V_{P-P}
On-screen input B	e_{22}		—	(0.71)	(1.0)	V_{P-P}
I ² C bus SDA input level H	V_8	V_{CC2} (= 5V)	(4.0)	—	V_{CC2}	V
I ² C bus SDA input level L	V_8	V_{CC2} (= 5V)	(0)	—	(0.7)	V
I ² C bus SCL input level H	V_{10}	V_{CC2} (= 5V)	(4.0)	—	V_{CC2}	V
I ² C bus SCL input level L	V_{10}	V_{CC2} (= 5V)	(0)	—	(0.7)	V
ACL terminal voltage range	V_{42}	V_{CC} : typ.	(2.7)	—	(4.5)	V

Note) The characteristics value in parentheses is not a guaranteed value, but reference one on design.



■ Pin Descriptions

Pin No.	Pin name	Waveform	Description	Equivalent circuit
1	GND	—————	GND for sync. and DEF	—————
2	503kHz VCO		Horizontal oscillation Pin. Connected to an external 503kHz oscillator element. DC=1.6V	
3	AFC2 filter		Phase adjuster of phase detection filter for image position adjustment Hi : Phase advance Lo : Phase delay	
4	High voltage det. input (X-ray)	DC	Shut down input pin Threshold voltage : 2.8 V	
5	High voltage det. ref. voltage	DC	Reference (comparison) voltage for shut down DC= 6.2V	

■ Pin Descriptions (cont.)

Pin No.	Pin name	Waveform	Description	Equivalent circuit
6	Horizontal drive pulse output		Output pin for horizontal drive pulse HI : 2.9V LO : 0V	
7	HV _{CC}	DC	Power supply voltage for horizontal system. V _{CC} =6.3V generated through an external resistor	
8	I ² C SDA input		SDA signal input and ACK signal output for I ² C	
9	I ² C GND	—	Ground for I ² C	—
10	I ² C SCL input		SCL signal input for I ² C	

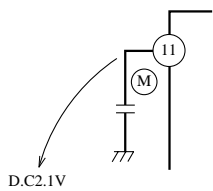
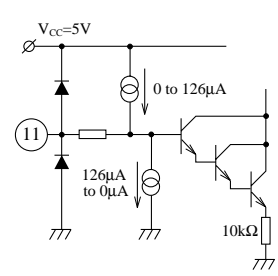
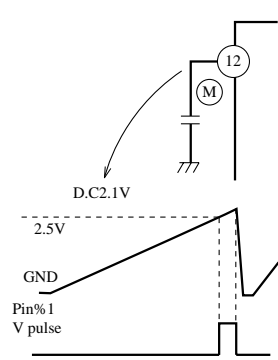
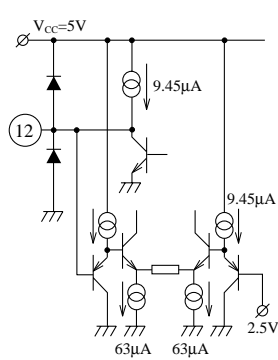
■ Pin Descriptions (cont.)

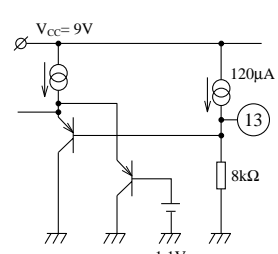
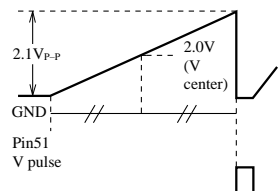
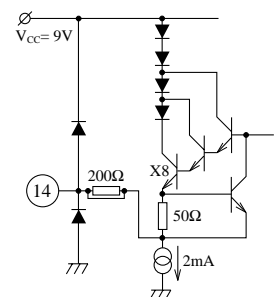
Pin No.	Pin name	Waveform	Description	Equivalent circuit
11	Reference ramp waveform AGC pin (Ramp-AGC)	<p>0.47μF capacitor is connected to Pin11.</p>  <p>D.C.2.1V</p>	Connecting to an AGC capacitor for making the amplitude of saw-tooth waveforms generated at Pin12 constant	 <p>$V_{CC}=5V$ 0 to 126μA 126μA to 0μA 10kΩ</p>
12	Reference ramp waveform (Ramp-Gen)	<p>0.33μF capacitor is connected to Pin12.</p>  <p>D.C.2.1V 2.5V GND Pin#1 V pulse</p>	Connecting to a reference saw-tooth waveform generation capacitor	 <p>$V_{CC}=5V$ 9.45μA 9.45μA 63μA 63μA 2.5V</p>
13	Corner slice level		Corner slice level correction	 <p>$V_{CC}=9V$ 120μA 8kΩ 1.1V</p>
14	Vertical deflection saw-tooth output (V-Ramp)	 <p>2.1V_{P-P} 2.0V (V center) GND Pin51 V pulse</p>	Vertical deflection saw-tooth output with various deflection-corrections	 <p>$V_{CC}=9V$ 200Ω X8 50Ω 2mA</p>

■ Pin Descriptions (cont.)

Pin No.	Pin name	Waveform	Description	Equivalent circuit
15	Pin cushion distortion correction output (EW-out)		Parabola wave for pin cushion correction with various deflection-corrections	
20	EHT voltage detection	The EHT correction occurs linearly when the input is between 4.0 to 2.0VDC. (Normally used at more than 4.0V)	High voltage fluctuation detection input for vertical and horizontal EHT corrections	
16	9V power supply (V _{CC} 9V)	—————	9V power supply	—————
17	R output	For maximum contrast with 1.0V _{P-P} R-Y and 0.5V _{P-P} Y inputs 	R signal output	
18	G output	For maximum contrast with 0.5V _{P-P} Y, 1.0V _{P-P} R-Y, and 1.27V _{P-P} B-Y 	G signal output	

■ Pin Descriptions (cont.)

Pin No.	Pin name	Waveform	Description	Equivalent circuit
19	B output	<p>For maximum contrast with $0.5V_{P-P}$ Y and $1.27V_{P-P}$ B-Y</p> <p>$3.75V_{P-P}$ $2.5V$ $1V$</p>	B signal output	
21	Y_S input		At on-screen input, the threshold level for switching between TV and on-screen is $0.7V$ typ.	
22	On-screen B input	<p>On-screen data</p> <p>$0.7V$ (typ.) typ. $3.3V$</p>	On-screen B input	
23	On-screen G input	<p>On-screen data</p> <p>$0.7V$ (typ.) typ. $3.3V$</p>	On-screen G input	

(Pin20 is described next to Pin15)

■ Pin Descriptions (cont.)

Pin No.	Pin name	Waveform	Description	Equivalent circuit
24	On-screen R input	<p>On-screen data</p> <p>typ. 3.3V</p> <p>0.7V (typ.)</p>	On-screen R input	<p>9V</p> <p>6.5V</p> <p>24</p> <p>Reference 2V</p> <p>BGP</p> <p>1.1mA</p>
25	Color difference B-Y input	<p>typ. 4.0V</p> <p>1.27V_{P-P}</p>	Color difference B-Y input	<p>9V</p> <p>6.5V</p> <p>25</p> <p>Reference 3.3V</p> <p>BGP</p> <p>1.1mA</p> <p>(Differential reference 3.3V)</p>
26	Color difference R-Y input	<p>1.0V_{P-P}</p>	Color difference R-Y input	<p>9V</p> <p>6.5V</p> <p>26</p> <p>Reference 2V</p> <p>BGP</p> <p>1.1mA</p>
27	V/C/RGB GND		GND for video, chroma and RGB	<p>⏏</p>
28	Color difference R-Y output	<p>1.0V_{P-P}</p> <p>3V</p>	Color difference R-Y signal output	<p>5V</p> <p>28</p> <p>300µA</p>

■ Pin Descriptions (cont.)

Pin No.	Pin name	Waveform	Description	Equivalent circuit
29	Color difference B-Y output		Color difference B-Y signal output	
30	3.58MHz oscillator		3.58-VCO oscillator	
31	APC filter		Chroma APC filter	
32	3.58M CW output		3.58-VCO oscillation output	

■ Pin Descriptions (cont.)

Pin No.	Pin name	Waveform	Description	Equivalent circuit
33	Killer filter	<p>2.9 to 4.5V</p>	<p>Killer detection filter</p> <p>Killer detection with reference to 3.5V</p>	
34	Color track filter	<p>3.2V</p> <p>300mV_{p-p}</p>	<p>Phase shift filter</p>	
36	Chroma input	<p>Color bar signal</p> <p>150mV_{p-p}</p> <p>Burst reference 0dB=150mV_{p-p}</p>	<p>Chroma input</p>	
37	5V power supply		<p>5V power supply</p>	
35	ABL input for brightness	<p>Adjustable in a $3 \pm 0.8V$ DC range</p>	<p>Brightness control</p>	

■ Pin Descriptions (cont.)

Pin No.	Pin name	Waveform	Description	Equivalent circuit
38	Blooming level input	2.7V DC when opened	Input for determination of blooming level Linked with the APL pin	
39	Filter for APL detection	0 to 3V DC	Filter for APL detection of image signals	
40	Filter for white detection	2 to 4V DC	Filter for detection of white max. image signals	

■ Pin Descriptions (cont.)

Pin No.	Pin name	Waveform	Description	Equivalent circuit
41	Filter for black detection Color control input	1 2 to 4V DC for black detection 2 2 to 4V DC for color control	1 Filter for detection of black max. image signals 2 Input for color control	
42	ACL input for Contrast	DC input voltage with an adjustment range of 2.7 to 4.5V	Contrast control	
43	Y signal input	0.5V _{P-P} standard input 0.36V (pedestal to white)	Y signal input	
44	V Sync.Sep.		Integral filter for vertical synchronous signal	
45	Sync.in (H)		<p>Slice level is variable with external resistor. Input for sync. signal separation</p> <p>H slice level : $3.9\mu\text{A} \times 2.2\text{k}\Omega \times 58.5\mu\text{s}/5\mu\text{s} = 100\text{mV}$</p>	

Pin Descriptions (cont.)

Pin No.	Pin name	Waveform	Description	Equivalent circuit
46	Sync.in (V)		<p>Slice level is variable with external resistor. Input for sync. signal separation</p> <p>V slice level : $2.6\mu\text{A} \times 6\text{k}\Omega \times 58.5\mu\text{s}/5\mu\text{s} = 183\text{mV}$</p>	
47	Lock Det. filter	<p>Synchronization : 6.2V</p> <p>Asynchronization : 0V</p> <p>Shut down : 8.3V</p>	<p>Filter for synchronization detection of input sync. and horizontal oscillation frequency. Also for shut down detection</p>	
48	Sand castle pulse input/FBP input for AFC		<p>Input of superimposed burst gate pulse and vertical/horizontal blanking</p> <ul style="list-style-type: none"> • Threshold voltages Burst gate pulse : 3.5V Horizontal blanking pulse : 2.2V Vertical blanking pulse : 1.0V AFC : 2.5V 	
49	Sand castle pulse output		<p>Output of superimposed burst gate pulse which superimposed V, H and blanking pulse, to synchronize the AN5307K with other ICs</p> <ul style="list-style-type: none"> • Threshold voltage Same as above 	
50	Flyback pulse input		<p>Input of flyback pulse</p> <ul style="list-style-type: none"> • Threshold voltage Blanking : 0.7V 	

■ Pin Descriptions (cont.)

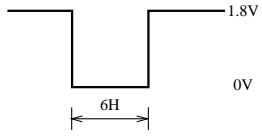
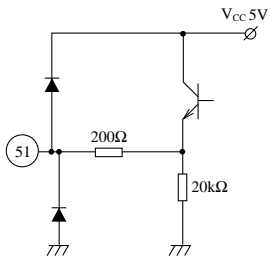
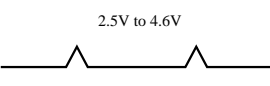
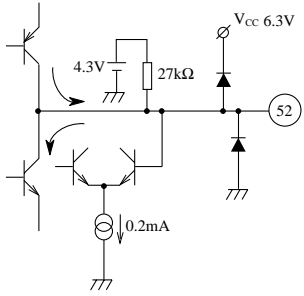
Pin No.	Pin name	Waveform	Description	Equivalent circuit
51	Vout.		Output of vertical oscillation pulse	
52	AFC1 Filter		Output of horizontal AFC current When RC network is connected, the horizontal AFC operates. Frequency adjustment Hi : Frequency low Lo : Frequency high	

■ Reference

