

AN5302K, AN5303K

NTSC Luminance Signal, Chroma-Signal and Synchronous Signal Processing ICs

Overview

The AN5302K and AN5303K are the integrated circuits for processing NTSC luminance, chroma and synchronous signals, incorporating the delay line, picture quality compensating circuits. They provide high picture quality and are suitable for high-performance large screen color TV.

Features

- Comb-type filter Y/C separating circuit built in
- Picture quality compensating circuit by delay line built in
- White peak limiter and black extension circuit built in
- Built-in adjustment-free APC filter.
- Adjustment-free horizontal/vertical oscillating circuit
- On-screen display R.G.B. switching circuit built in

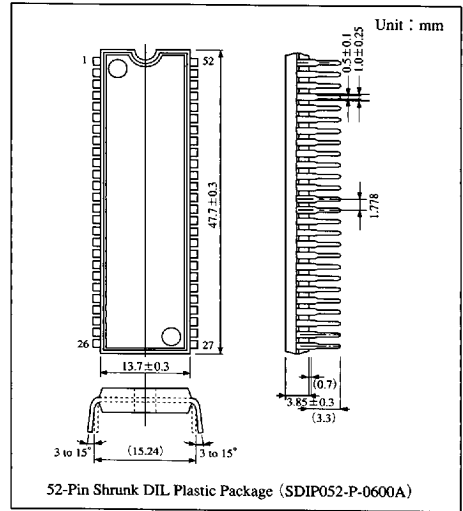

Block Diagram

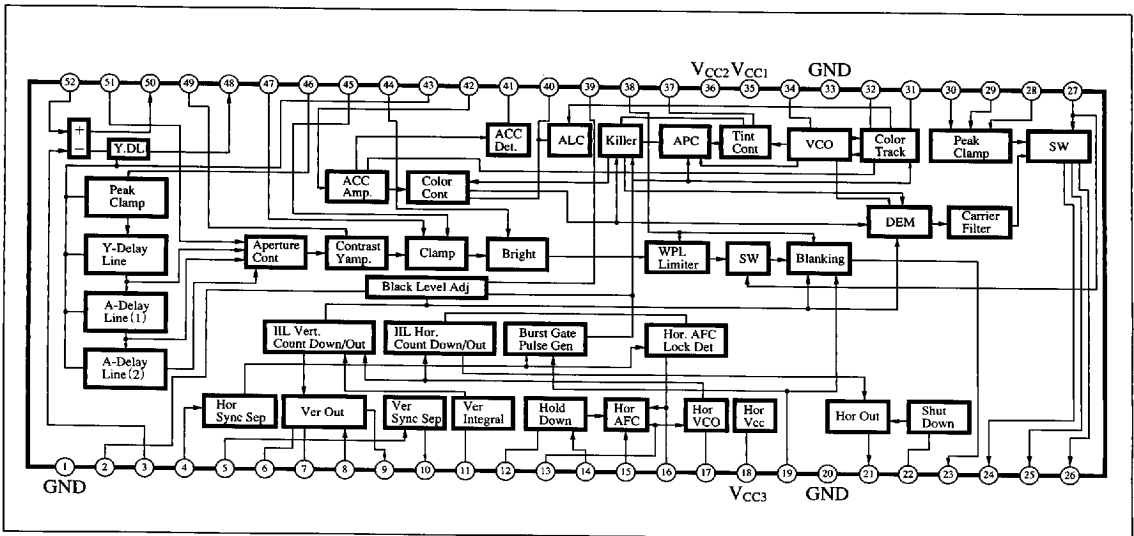

6932852 0014213 903

Panasonic

■ Absolute Maximum Ratings (Ta=25°C)

Parameter	Symbol	Rating		Unit
Supply voltage	V _{CC} Note 1)	I ₁₈	25	mA
		V _{35-1, 20, 33}	13.2	
		V _{36-1, 20, 33}	9.9	V
Power dissipation (Ta=70°C)	P _D Note 2)	1300		mW
Operating ambient temperature	T _{opr}	-20 to +70		°C
Storage temperature	T _{stg}	-55 to +150		°C

Note 1) V_{CC1} ≥ V_{CC2} Note 2) V_{CC1} ≤ 13.8V and V_{CC2} ≤ 10.35V within a range of P_D

■ Recommended Operating Range (Ta=25°C)

Parameter	Symbol	Range
Operating supply voltage range 1	V _{CC1}	7.6V to 13.2V
Operating supply voltage range 2	V _{CC2}	7.6V to 9.9V

Note 1) V_{CC1} ≥ V_{CC2}

■ Electrical Characteristics (Ta=25°C)

Parameter	Symbol	Condition	min	typ	max	Unit
Circuit current (1)	I ₃₆	V _{CC1} =12V, V _{CC2} =9V, I ₁₈ =13.5mA	41	48	61	mA
Circuit current (2)	I ₃₅	V _{CC1} =12V, V _{CC2} =9V, I ₁₈ =13.5mA	20	24	30	mA

Luminance Signal Processing Circuit

Video voltage gain	A _V	Video input : Sine wave 0.2V _{P-P} , 2MHz Cont : max., aperture : min., Brightness : 3V	11.8	13.5	15.2	times
Video frequency characteristics	f _{YC}	Frequency at -3dB when output level is f=2MHz	7	—	—	MHz
Picture quality variable range	$\frac{A_{Styp.}}{A_{Smin.}}$	f=4MHz	9	12.5	15	dB
Contrast variable range	$\frac{e_{max.}}{e_{min.}}$	Video input : Staircase 0.2V _{P-P} , 2MHz Cont : max. to min., aperture : min., Brightness : 3V	14.2	16	18.2	dB
Brightness oscillator sensitivity	BR	Brightness : 2.5V, 3.5V Δ (BR _{3.5V} - BR _{2.5V})/1V	-1.7	-1.4	-1.2	V/V
Direct current re-generation rate *1	T _{DC}	Cont : max., aperture : min., Video input : 0.4V _{P-P} , APL10% to 90%	94	97	105	%

Chroma Signal Processing Circuit

Typical color difference output	e ₀₁	Chroma bar signal (Burst 200mV _{P-P}) Cont : typ., Color : typ., B - Y output	1.1	1.4	1.7	V _{P-P}
Color difference output (color remaining)	e ₀₃	Chroma bar signal (Burst 200mV _{P-P}) Cont : typ., Color : min., B - Y output	—	35	60	mV _{P-P}
Demodulation output ratio (1)	R/B	Chroma bar signal (Burst 200mV _{P-P}) Cont : typ., Color : typ.	1.2	1.35	1.5	times
Demodulation output ratio (2)	G/B	Chroma bar signal (Burst 200mV _{P-P}) Cont : typ., Color : typ.	0.3	0.38	0.45	times
Demodulation angle R	∠R	Chroma bar signal (Burst 200mV _{P-P}) Cont : typ., Color : typ.	91	96	101	deg
Demodulation angle G	∠G	Chroma bar signal (Burst 200mV _{P-P}) Cont : typ., Color : typ.	225	235	245	deg
Tint variable range	∠θ t	Chroma bar signal (Burst 200mV _{P-P}) Cont : typ., Color : typ., Tint : min. → max.	±25	±45	—	deg
APC pull-in range	f _{PC}	Change burst frequency	±500	±650	—	Hz
VCO free running frequency *2	f _{CO}	No signal, ACC : off, adjust by trimmer capacitor with typical sample.	-150	0	150	Hz

Note) Unless otherwise specified, supply voltage should be V_{CC1}=12V, V_{CC2}=9V and I₁₈=13.5mA.

*1 Can be adjusted from 100% to 130% by the external resistance of Pin④

*2 f₀=3.579545MHz, standard value C of capacitor = 8pF

■ 6932852 0014214 847 ■

■ Electrical Characteristics (cont.) ($T_a=25^\circ\text{C}$)

Parameter	Symbol	Condition	min	typ	max	Unit
Horizontal Signal Processing Circuit						
Synchronous separable input	e_{COM}	Positive polarity	1	—	2.8	V_{P-P}
Horizontal free oscillation frequency *3	$f_{\text{HO-1}}$	$I_{18}=13.5\text{mA}$, $C=470\text{pF}$, $R=100\Omega$ Output frequency of Pin②	15.45	15.75	16.05	kHz
Horizontal output pulse duty	τ_{HO}	$I_{18}=13.5\text{mA}$, Hold Down Off	34.4	37.5	40.6	%
Horizontal pull-in range *4	f_{PH}	Constant of filter : Application circuit, $f_{\text{HO}}=15.75\text{kHz}$	15.25	15.75	16.25	kHz
Vertical Signal Processing Circuit						
Vertical free oscillation frequency	f_{VO}	$\left[\frac{2}{525} f_{\text{H}} \right]$	58.8	60	61.2	Hz
Vertical free oscillation pulse width	τ_{VO}	$(10/f_{\text{H}})$	610	640	670	μs

Note) Unless otherwise specified, supply voltage should be $V_{\text{CC1}}=12\text{V}$, $V_{\text{CC2}}=9\text{V}$ and $I_{18}=13.5\text{mA}$.



*3 $\pm 300\text{Hz}$ *4 $15.75\text{Hz} \pm 500\text{Hz}$



6932852 0014215 786

Panasonic

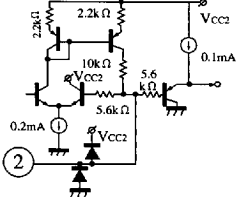
Pin Descriptions

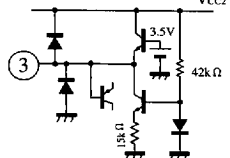
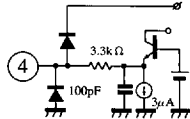
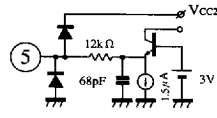
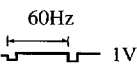
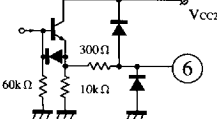
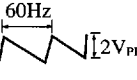
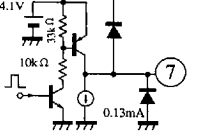
Pin No.	Pin name	Typ. waveform	Description	I/O impedance	Equivalent circuit
1	Vertical GND	—	GND pin.	0	
2	Black level detecting filter	DC	Black level detecting pin.	2.8k Ω	
3	Composite video input 1		Composite video input pin. Input a 1H-delayed signal from this pin to Pin 52.	0	
4	Horizontal synchronous separation input	Same as above	Input pin for synchronous separation.	3.3k Ω	
5	Vertical synchronous separation input	Same as above	Input pin for synchronous separation.	12k Ω	
6	Vertical output		Vertical pre-drive output pin.	300 Ω	
7	Vertical sawtooth wave capacitor		Pin for generating vertical sawtooth wave. A sawtooth wave is generated by connecting the capacitor.	∞	

ICs for TV

6932852 0014217 559

Panasonic

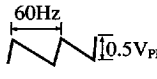
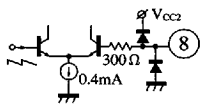
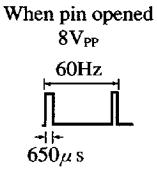
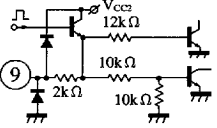
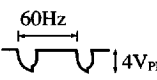
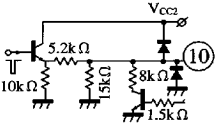
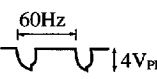
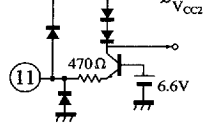
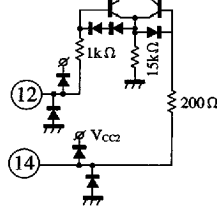

Pin Descriptions (cont.)

Pin No.	Pin name	Typ. waveform	Description	I/O impedance	Equivalent circuit
8	Vertical feedback input		Feedback input pin for compensating vertical linearity. Compare a sawtooth wave of Pin⑦ with DY-output.	∞	
9	Vertical pulse output		Vertical oscillation pulse output pin.	2k Ω	
10	Vertical integral filter		Integral filter (Low-pass filter) pin for vert. synch. Put out composite synch. of negative polarity obtained from the vertical synchronous separation circuit.	3.9k Ω	
11	Vertical synchronous separation input		Vertical synchronous signal input pin. Input a vertical synchronous signal obtained from the integral filter, and synchronize IC.	470 Ω	
12	High voltage detection input (Hold down input)	DC	Input pin for activating the protection circuit when high voltage is detected. 1) $V_{12} > V_{14}$ Set horizontal oscillation frequency to 16.5kHz and make the screen the asynchronous state. 2) $V_{12} > V_{14} + V_{BE}$ Blank output.	∞	
14	Hold down reference voltage	DC	Reference voltage for the high voltage detecting is biased.	1k Ω	

6932852 0014218 495

Panasonic

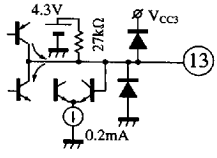
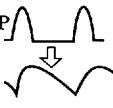
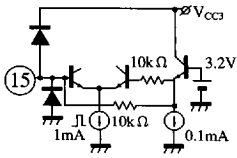
Pin Descriptions (cont.)

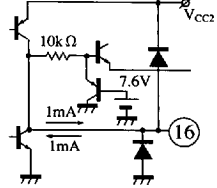
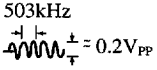
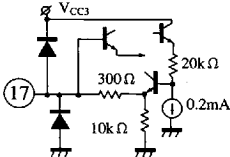
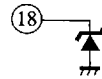
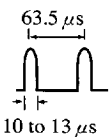
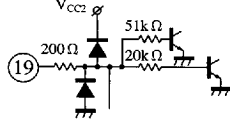

Pin No.	Pin name	Typ. waveform	Description	I/O impedance	Equivalent circuit
13	Horizontal AFC filter		Horizontal AFC current output pin. Horizontal AFC operates by connecting filter RC.	0	
15	Phase comparing FBP input		Horizontal AFC comparison signal input pin. Usually, input integrated FBP through the capacitor.	10k Ω	
16	Synchronization detecting filter	Synchronized state = 9V  Asynchronized state = 0V 	Filter pin for detecting synchronization of horizontal oscillation frequency. Connect the filter RC. Synchronized state = 9V. Asynchronized state = 0V.	10k Ω	
17	503kHz oscillation	503kHz 	Horizontal oscillation pin. Oscillation is made by connecting the 503kHz resonator.	300 Ω	
18	Supply voltage 3 (Horizontal supply voltage)	DC	Horizontal supply voltage pin.	0	
19	Horizontal blanking pulse input		Horizontal blanking pulse input pin. A blanking pulse is used not only for the clamp pulse generator but also for the color blanking, Y blanking and black level compensating circuits.	∞	

ICs for TV

6932852 0014219 321

Panasonic

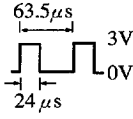
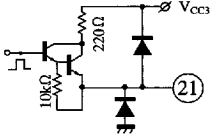
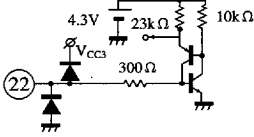
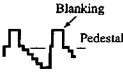
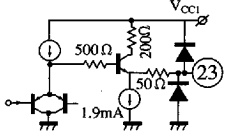
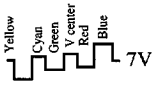
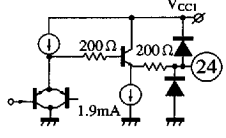

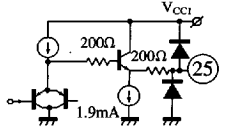
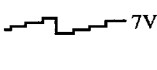
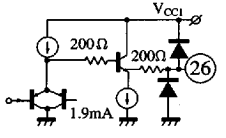
Pin Descriptions (cont.)

Pin No.	Pin name	Typ. waveform	Description	I/O impedance	Equivalent circuit
20	Horizontal GND	DC	GND pin for horizontal circuit.	0	
21	Horizontal drive pulse output		Horizontal pre-drive pulse output pin.	0	
22	High voltage detection input (Shut down input)	DC	Shut down input pin. When the voltage of 0.6 to 0.8V or more is applied, the shut-down function is activated to disallow horizontal output. Should be grounded when shut down function is not used.	—	
23	Y output		Y signal output pin.	50Ω	
24	B-Y output		B-Y color difference output pin and external B output pin.	200Ω	
25	G-Y output		G-Y color difference output pin and external G output pin.	200Ω	
26	R-Y output		R-Y color difference output pin and external R output pin.	200Ω	

6932852 0014220 043

Panasonic

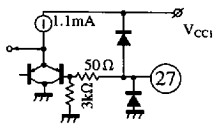
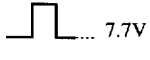
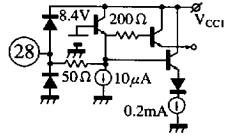
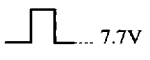
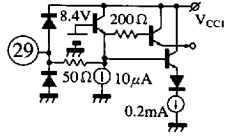
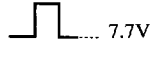
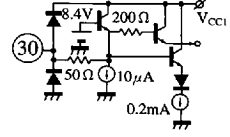
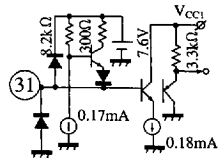
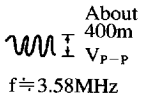
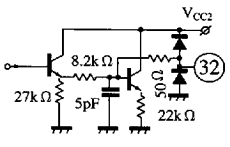
■ Pin Descriptions (cont.)



Pin No.	Pin name	Typ. waveform	Description	I/O impedance	Equivalent circuit
27	Y _s input		Switching pulse input pin for switching the color difference signal (C-Y) and external signal (R.G.B).	305 Ω	
28	B input		External B input pin. Input signal through the capacitor. Signal is clamped by internal bias.	200 Ω	
29	G input		External G input pin. Input signal through the capacitor. Signal is clamped by internal bias.	200 Ω	
30	R input		External R input pin. Input signal through the capacitor. Signal is clamped by internal bias.	200 Ω	
31	AIC filter flesh color Compensation ON/OFF	DC	AIC filter circuit and flesh color compensating circuit ON/OFF SW pin. Use with the resistor inserted between the pin and GND. OFF when the pin voltage is set to V _{CC2} .	100 Ω	
32	Flesh color phase adjustment		Pin for adjusting the phase of flesh color compensating circuit. Adjust the phase by the external L.C.	2k Ω	
33	Video chroma GND		Video chroma circuit GND pin.	0	

ICs for TV

■ 6932852 0014221 T8T ■

Panasonic

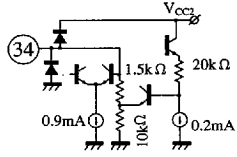
Pin Descriptions (cont.)

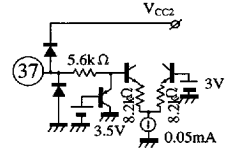
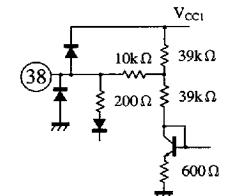
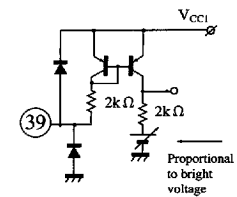
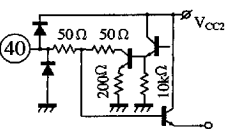
Pin No.	Pin name	Typ. waveform	Description	I/O impedance	Equivalent circuit
34	3.58MHz oscillation	 $f \approx 3.58\text{MHz}$	Chroma 3.58MHz oscillation pin. Oscillation is made by the external crystal resonator and capacitor.	1.5k Ω	
35	Supply voltage 1 (V _{CC1})	DC	Power pin for video chroma output circuit. typ.12V	0	
36	Supply voltage 2 (V _{CC2})	DC	Power pin for video chroma and vertical circuits. typ.9V	0	
37	Tint control	DC	Tint control pin. Operates at external voltage of 0V to 5V.	5.6k Ω	
38	White peak limit adjustment	DC	White peak limiter adjusting pin. When the pin voltage is set to V _{CC} =12V, no blanking of Y and color difference output is performed.	49k Ω	
39	Black level start point adjustment	DC	Pin for adjusting the start point of the black level compensating circuit. Use R between this pin and GND.	∞	
40	Color control	DC	Color level control pin. Operate at the external voltage of 0V to 5V. When the pin voltage is set to V _{CC2} , the unkiller circuit is activated to prevent the killer from operating.	5.6k Ω	

6932852 0014222 916

Panasonic

Pin Descriptions (cont.)







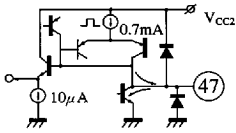

Pin No.	Pin name	Typ. waveform	Description	I/O impedance	Equivalent circuit
41	ACC detection filter	DC	ACC detection filter pin. Use with R.C inserted in parallel between this pin and V_{CC2} .	$1k\ \Omega$	
42	Chroma signal input	 $f \approx 3.58\text{MHz}$ Burst Signal typ. 200mV _{PP}	Chroma signal (external) input pin. When a signal is input through capacitor and the pin voltage increased to V_{CC2} by the external R ($8.2k\ \Omega$), the operation of the Y/C separation operating-circuit stops.	$11.2k\ \Omega$	
43	Delay time adjustment	DC	Pin for adjusting the delay time of a video signal. Adjust the delay time by the external variable resistor.	$5.6k\ \Omega$	
44	Brightness control	DC	Brightness control pin.	∞	
45	Direct current regeneration adjustment		Direct current regeneration adjusting pin. The regeneration of direct current can be changed from 100% to 130% by the external resistor with the capacitor connected.	$5.6k\ \Omega$	
46	Video signal input	 1H 2V	Video signal input pin.	≈ 0	

ICs for TV

6932852 0014223 852

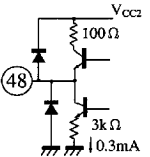
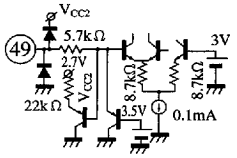
Panasonic

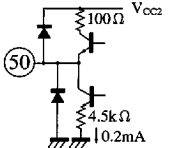
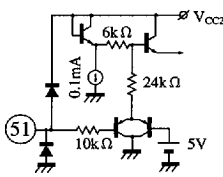
■ Pin Descriptions (cont.)

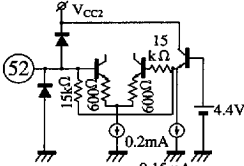
Pin No.	Pin name	Typ. waveform	Description	I/O impedance	Equivalent circuit
47	Y clamping capacitor	DC	Y clamping capacitor pin.	∞	
48	Y/C separation output 1 (Y)	Pin③  Pin⑤②  Pin④⑧ 	When a composite video signal is input to Pin③ and a 1H-delayed composite video signal to Pin⑤②, Y signal is output to Pin④⑧.	≈ 0	
49	Contrast control	DC	Contrast control pin. This pin serves as the service switch for stopping a vertical synchronous signal.	5.6k Ω	
50	Y/C separation output 2 (C)		When a composite video signal is input to Pin③ and a 1H-delayed composite video signal to Pin⑤②, the result of operation is output to Pin⑤①.	≈ 0	
51	Picture quality adjustment	DC	Picture quality adjusting control pin.	∞	
52	Composite video input (1H delay)		Input a 1H-delayed signal from input signal of Pin③.	15k Ω	

■ 6932852 0014224 799 ■

Panasonic

■ Supplementary Explanation

• Characteristic Curve

Characteristics① of Output Change by Each Control Pin [Chroma Characteristics]

Tint Variable Characteristics

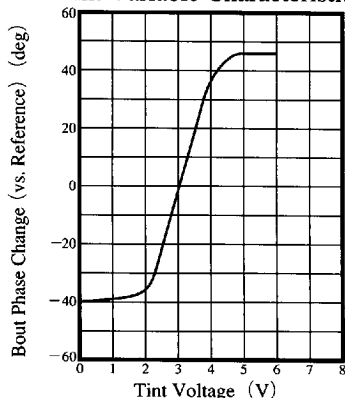

Chroma Variable Characteristics

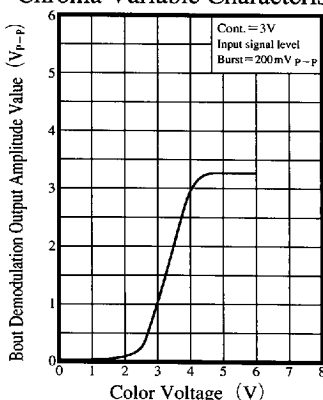

Contrast Variable Characteristics (Chroma)

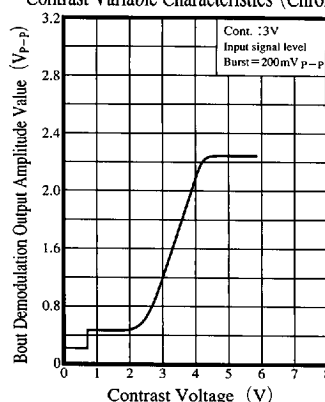

Characteristics② of Output Change by Each Control Pin [Video Characteristics]



Luminance Variable Characteristics

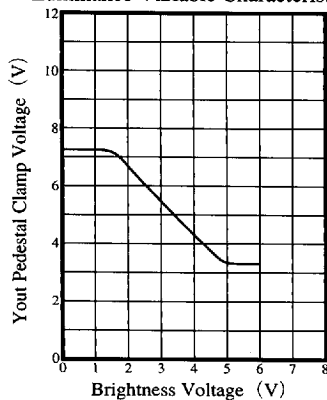

Chroma Variable Characteristics (Video)

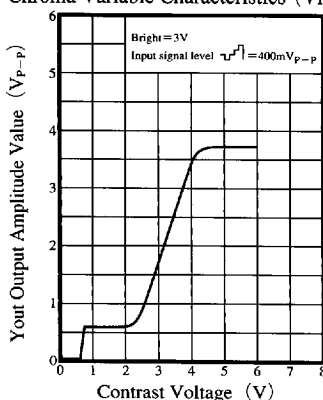

Characteristics of Delay Change by Delay Adjusting Pin

Delay Change Characteristics

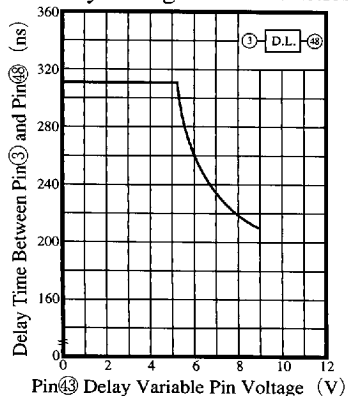

Delay Time Between Pin④⑥ and Pin③ (ns)

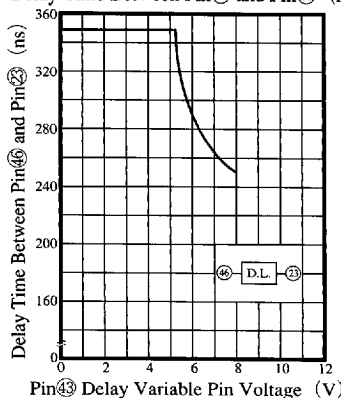

Panasonic

6932852 0014225 625

• Characteristic Curve (cont.)

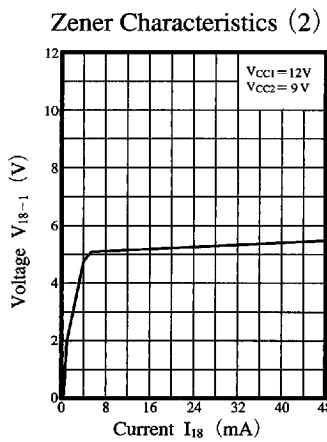
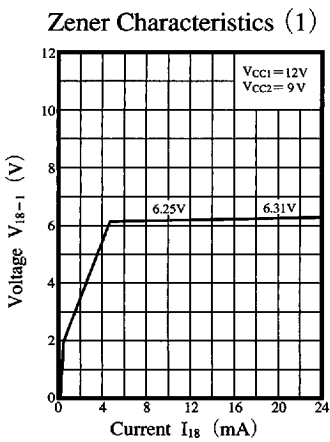
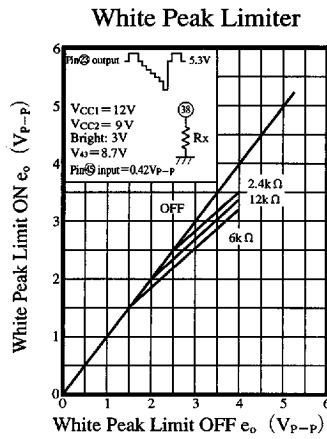
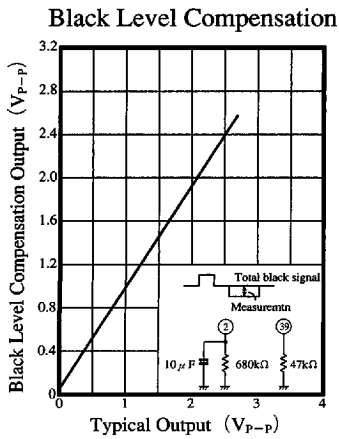
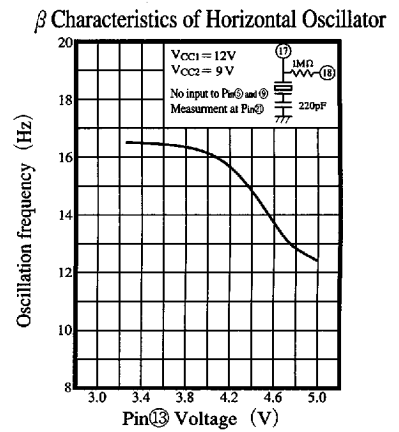
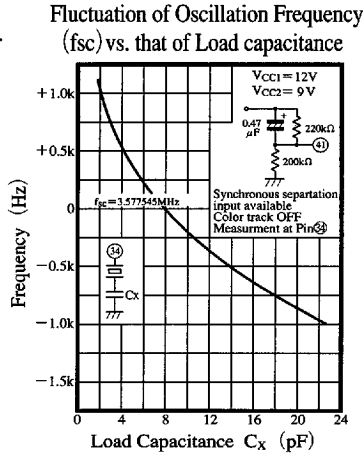
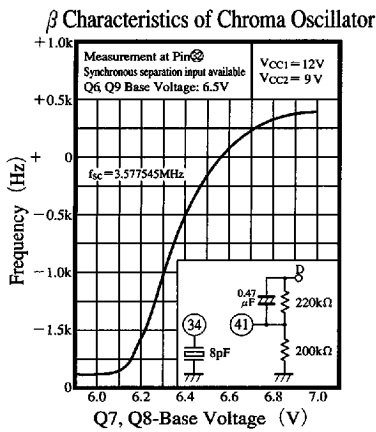

6932852 0014226 561

Panasonic