

# 74F37

## Quad Two-Input NAND Buffer

### General Description

This device contains four independent gates, each of which performs the logic NAND function.

### Ordering Code:

Order Number	Package Number	Package Description
74F37SC	M14A	14-Lead Small Outline Integrated Circuit (SOIC), JEDEC MS-120, 0.150 Narrow
74F37SJ	M14D	14-Lead Small Outline Package (SOP), EIAJ TYPE II, 5.3mm Wide
74F37PC	N14A	14-Lead Plastic Dual-In-Line Package (PDIP), JEDEC MS-001, 0.300 Wide

Devices also available in Tape and Reel. Specify by appending the suffix letter "X" to the ordering code.

### Logic Symbol

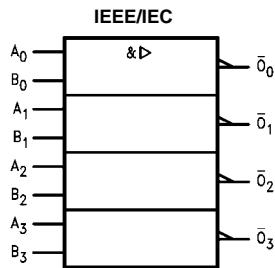

### Connection Diagram

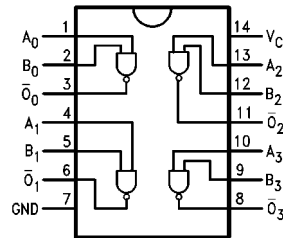

### Unit Loading/Fan Out

Pin Names	Description	U.L.	Input $I_H/I_L$
		HIGH/LOW	Output $I_{OH}/I_{OL}$
$A_n, B_n$	Inputs	1.0/2.0	20 $\mu$ A/-1.2 mA
$\bar{O}_n$	Outputs	600/106.6 (80)	-12 mA/64 mA (48 mA)

### Function Table

Inputs		Output
A	B	$\bar{O}$
L	L	H
L	H	H
H	L	H
H	H	L

H = HIGH Voltage Level  
L = LOW Voltage Level

**Absolute Maximum Ratings** (Note 1)

Storage Temperature	-65°C to +150°C
Ambient Temperature under Bias	-55°C to +125°C
Junction Temperature under Bias	-55°C to +150°C
V <sub>CC</sub> Pin Potential to Ground Pin	-0.5V to +7.0V
Input Voltage (Note 2)	-0.5V to +7.0V
Input Current (Note 2)	-30 mA to +5.0 mA
Voltage Applied to Output in HIGH State (with V <sub>CC</sub> = 0V)	
Standard Output	-0.5V to V <sub>CC</sub>
3-STATE Output	-0.5V to +5.5V
Current Applied to Output in LOW State (Max)	twice the rated I <sub>OL</sub> (mA)

**Recommended Operating Conditions**

Free Air Ambient Temperature	0°C to +70°C
Supply Voltage	+4.5V to +5.5V

**Note 1:** Absolute maximum ratings are values beyond which the device may be damaged or have its useful life impaired. Functional operation under these conditions is not implied.

**Note 2:** Either voltage limit or current limit is sufficient to protect inputs.

**DC Electrical Characteristics**

Symbol	Parameter	Min	Typ	Max	Units	V <sub>CC</sub>	Conditions
V <sub>IH</sub>	Input HIGH Voltage	2.0			V		Recognized as a HIGH Signal
V <sub>IL</sub>	Input LOW Voltage			0.8	V		Recognized as a LOW Signal
V <sub>CD</sub>	Input Clamp Diode Voltage			-1.2	V	Min	I <sub>IN</sub> = -18 mA
V <sub>OH</sub>	Output HIGH Voltage	10% V <sub>CC</sub> 10% V <sub>CC</sub> 5% V <sub>CC</sub>	2.4 2.0 2.7		V	Min	I <sub>OH</sub> = -3 mA I <sub>OH</sub> = -15 mA I <sub>OH</sub> = -3 mA
V <sub>OL</sub>	Output LOW Voltage	10% V <sub>CC</sub>		0.55	V	Min	I <sub>OL</sub> = 64 mA
I <sub>IH</sub>	Input HIGH Current			5.0	μA	Max	V <sub>IN</sub> = 2.7V
I <sub>BVI</sub>	Input HIGH Current Breakdown Test			7.0	μA	Max	V <sub>IN</sub> = 7.0V
I <sub>CEX</sub>	Output HIGH Leakage Current			50	μA	Max	V <sub>OUT</sub> = V <sub>CC</sub>
V <sub>ID</sub>	Input Leakage Test	4.75			V	0.0	I <sub>ID</sub> = 1.9 μA All Other Pins Grounded
I <sub>OD</sub>	Output Leakage Circuit Current			3.75	μA	0.0	V <sub>IOD</sub> = 150 mV All Other Pins Grounded
I <sub>IL</sub>	Input LOW Current			-1.2	mA	Max	V <sub>IN</sub> = 0.5V
I <sub>OS</sub>	Output Short-Circuit Current	-100		-225	mA	Max	V <sub>OUT</sub> = 0V
I <sub>CCH</sub>	Power Supply Current		3.7	6.0	mA	Max	V <sub>O</sub> = HIGH
I <sub>CCL</sub>	Power Supply Current		28.0	33.0	mA	Max	V <sub>O</sub> = LOW

**AC Electrical Characteristics**

Symbol	Parameter	T <sub>A</sub> = +25°C V <sub>CC</sub> = +5.0V C <sub>L</sub> = 50 pF			T <sub>A</sub> = 0°C to +70°C C <sub>L</sub> = 50 pF		Units
		Min	Typ	Max	Min	Max	
t <sub>PLH</sub>	Propagation Delay	2.0	3.2	5.5	1.5	6.5	ns
t <sub>PHL</sub>	A <sub>n</sub> , B <sub>n</sub> to $\bar{O}_n$	1.5	2.4	4.5	1.0	5.0	

**Physical Dimensions** inches (millimeters) unless otherwise noted

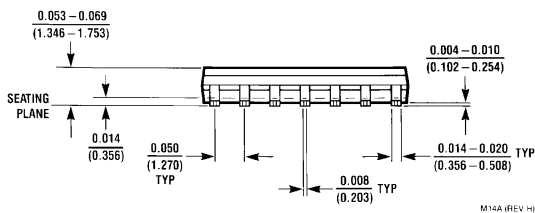
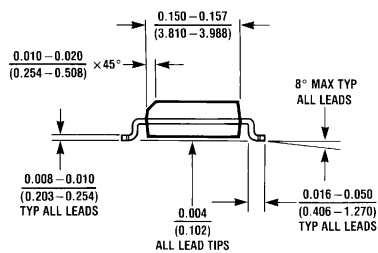
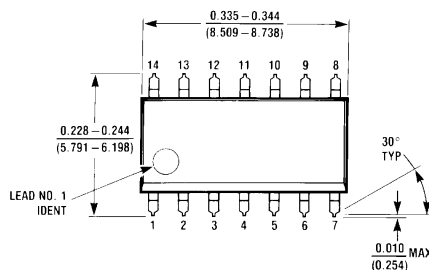

**14-Lead Small Outline Integrated Circuit (SOIC), JEDEC MS-120, 0.150 Narrow Package Number M14A**

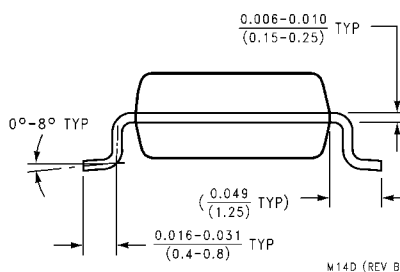
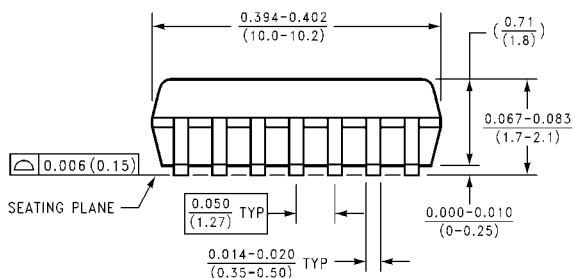
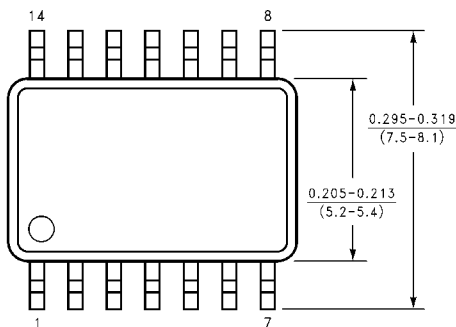

**14-Lead Small Outline Package (SOP), EIAJ TYPE II, 5.3mm Wide Package Number M14D**

**Physical Dimensions** inches (millimeters) unless otherwise noted (Continued)

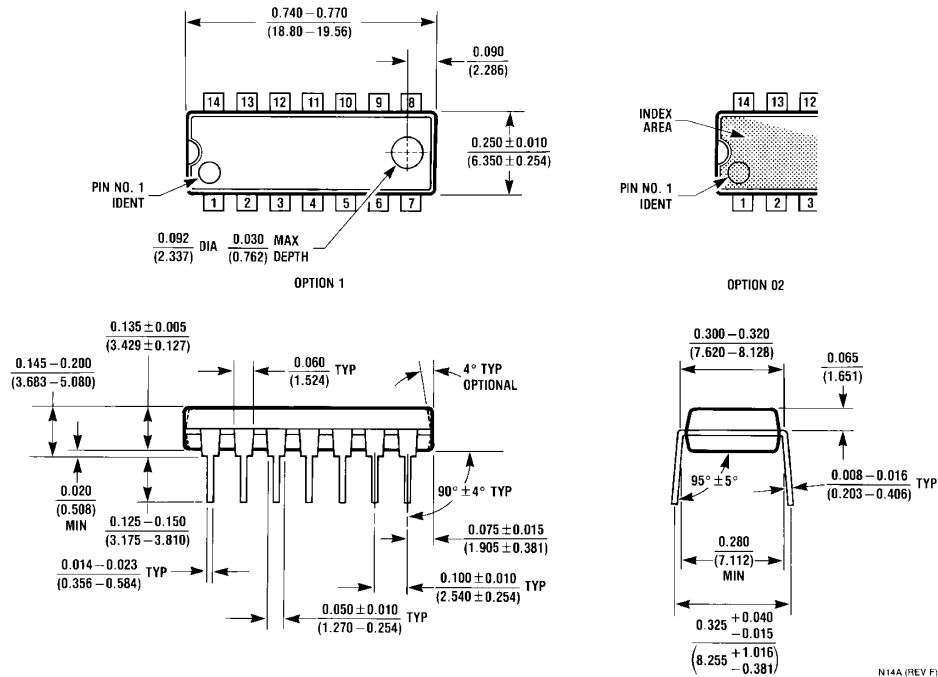

**LIFE SUPPORT POLICY**

FAIRCHILD'S PRODUCTS ARE NOT AUTHORIZED FOR USE AS CRITICAL COMPONENTS IN LIFE SUPPORT DEVICES OR SYSTEMS WITHOUT THE EXPRESS WRITTEN APPROVAL OF THE PRESIDENT OF FAIRCHILD SEMICONDUCTOR CORPORATION. As used herein:

1. Life support devices or systems are devices or systems which, (a) are intended for surgical implant into the body, or (b) support or sustain life, and (c) whose failure to perform when properly used in accordance with instructions for use provided in the labeling, can be reasonably expected to result in a significant injury to the user.
2. A critical component in any component of a life support device or system whose failure to perform can be reasonably expected to cause the failure of the life support device or system, or to affect its safety or effectiveness.

[www.fairchildsemi.com](http://www.fairchildsemi.com)